

one dollar

# ham radio

magazine

hr 

**JANUARY 1976**

- 50-MHz frequency counter 18
- microprocessors 36
- wideband linear amplifier 42
- 432-MHz Yagi 46
- audio power ICs 64



**synthesized  
two-meter fm  
transceiver**

# Henry Radio has the amplifier you want

Never before has one company manufactured such a broad line of amateur amplifiers, both vacuum tube and solid state, for HF, VHF and UHF; fixed station and mobile; low power and high power. Take your pick from 20 models...the world's finest line of amateur amplifiers.



## 2K-4... THE "WORKHORSE"

The 2K-4 linear amplifier offers engineering, construction and features second to none, and at a price that makes it the best amplifier value ever offered to the amateur. Constructed with a ruggedness guaranteed to provide a long life of reliable service, its heavy duty components allow it to loaf along even at full legal power. If you want to put that strong clear signal on the air that you've probably heard from other 2K users, now is the time. Move up to the 2K-4. Floor console or desk model...\$995.00

## 3K-A COMMERCIAL/MILITARY AMPLIFIER

A high quality linear amplifier designed for commercial and military uses. The 3K-A employs two rugged Eimac 3-500Z grounded grid triodes for superior linearity and provides a conservative three kilowatts PEP input on SSB with efficiencies in the range of 60%. This results in PEP output in excess of 2000 watts. In addition, the 3K-A provides a heavy duty power supply capable of furnishing 2000 watts of continuous duty input for either RTTY or CW with 1200 watts output. Price...\$1250.00

## 4K-ULTRA

The 4K-ULTRA is specifically designed for the most demanding commercial and military operation for SSB, CW, FSK or AM. The amplifier features general coverage operation from 3.0 to 30 MHz. Using the magnificent new Eimac 8877 grounded grid triodes, vacuum tune and load condensers, and a vacuum antenna relay, the 4K-ULTRA represents the last word in rugged, reliable, linear high power RF amplification. 100 watts drive delivers 4000 watts PEP input. This amplifier can be supplied modified for operation on frequencies up to about 100MHz. Price...\$2950.00

## TEMPO T-2000 LINEAR AMPLIFIER

The brand new T-2000 linear is the perfect companion for the Tempo ONE. It is compact, reliable, and priced right. Uses two Eimac 8873 grounded grid triodes cooled through a large heat sink. The T-2000 offers a full 2 KW PEP input for SSB operation and provides

amateur band coverage from 80-10 meters. Provides a built-in solid state power supply, built-in antenna relay, a relative RF power indicator, and built-in quality to match much more expensive amplifiers. \$795.00

## K-2000 LINEAR AMPLIFIER

The new K-2000 is the perfect companion for Kenwood's TS-520...matched for style and circuitry. The same specifications as the T-2000...\$795.00

## TEMPO 6N2

The Tempo 6N2 brings the same high standards of performance and reliability to the 6 meter and 2 meter bands. Using a pair of advanced design Eimac 8874 tubes, it provides 2,000 watts PEP input on SSB or 1,000 watts input on FM or CW. The 6N2 is complete in one compact cabinet with a self-contained solid state power supply, built-in blower and RF relative power indicator. Price...\$795

## TEMPO 2002

The same fine specs and features as the 6N2, but for 2 meter operation only. ...\$695.00

## TEMPO 2006

Like the 2002, but for 6 meter operation. ...\$695.00

## TEMPO VHF/UHF AMPLIFIERS

Solid state power amplifiers for use in most land mobile applications. Increases the range, clarity, reliability and speed of two-way communications. FCC type accepted also.

please call or write for complete information.

# Henry Radio

11240 W. Olympic Blvd., Los Angeles, Calif. 90064 213/477-6701  
931 N. Euclid, Anaheim, Calif. 92801 714/772-9200  
Butler, Missouri 64730 816/679-3127

**NOW.**  
*Top-of-the-Line*  
**Tri-Ex Towers**  
*for HAM operators*  
*at basic prices!*

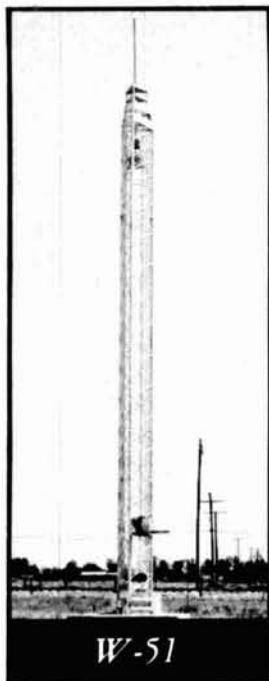

**W-51**

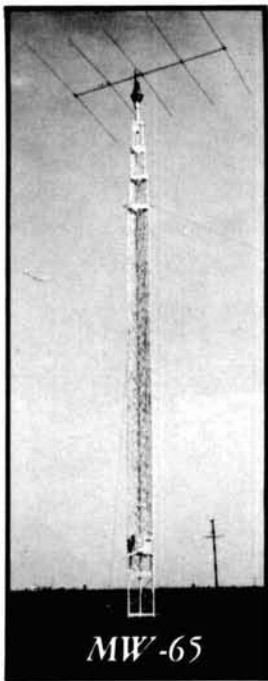

**MW-65**

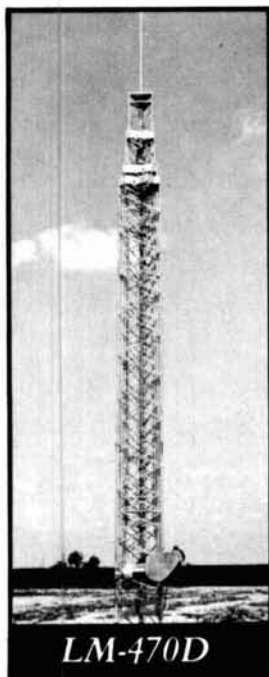

**LM-470D**

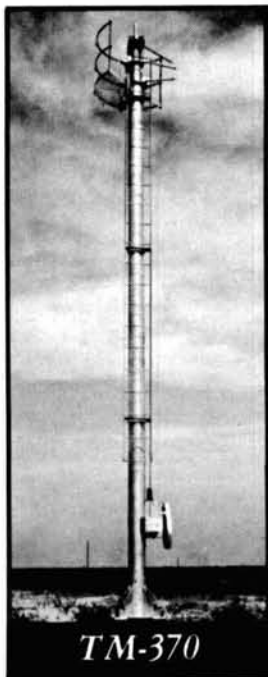

**TM-370**

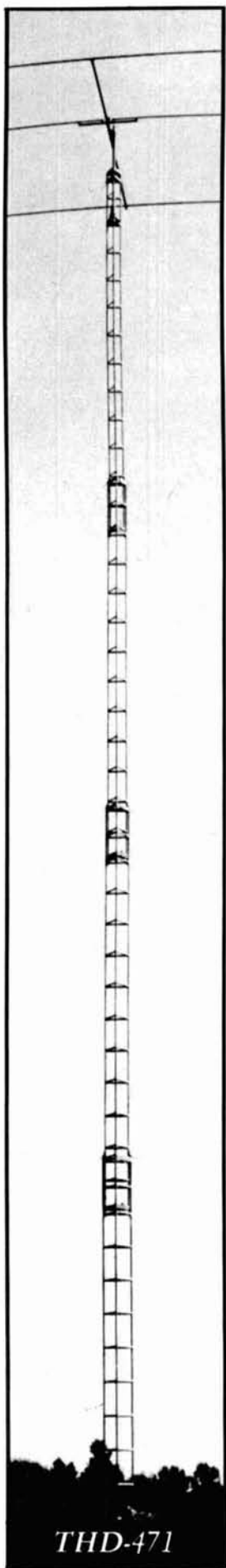

**THD-471**

Now you can afford the best! Free-standing or guyed, Tri-Ex Towers stress quality. All towers are hot dipped galvanized *after* fabrication for longer life. Each series is specifically engineered to HAM operator requirements.

**W Series**

An aerodynamic tower designed to hold 9 square feet in a 50 mph wind. Six models at different heights.

**MW Series**

Self-supporting when attached at first section — will hold normal Tri-Band beam. Six models.

**LM Series**

A 'W' brace motorized tower. Holds large antenna loads up to 70 feet high. Super buy.

**TM Series**

Features tubular construction for really big antenna loads. Up to 100 feet. Free-standing, with motors to raise and lower.

**THD Series**

Very popular. Low Cost. Holds Tri-Band antennas. Eight models — all support 7 square feet of antenna at full height in 70 mph winds. Guyed.

Start with Top-of-the-Line Tri-Ex Towers. At basic prices. Write today, for your best buy.



7182 Rasmussen Ave.  
 Visalia, Calif. 93277

# ME-3 microminiature tone encoder

Compatible with all sub-audible tone systems such as: Private Line, Channel Guard, Quiet Channel, etc.

- Powered by 6-16vdc, unregulated
- Microminiature in size to fit inside all mobile units and most portable units
- Field replaceable, plug-in, frequency determining elements
- Excellent frequency accuracy and temperature stability
- Output level adjustment potentiometer
- Low distortion sinewave output
- Available in all EIA tone frequencies, 67.0 Hz-203.5 Hz
- Complete immunity to RF
- Reverse polarity protection built-in

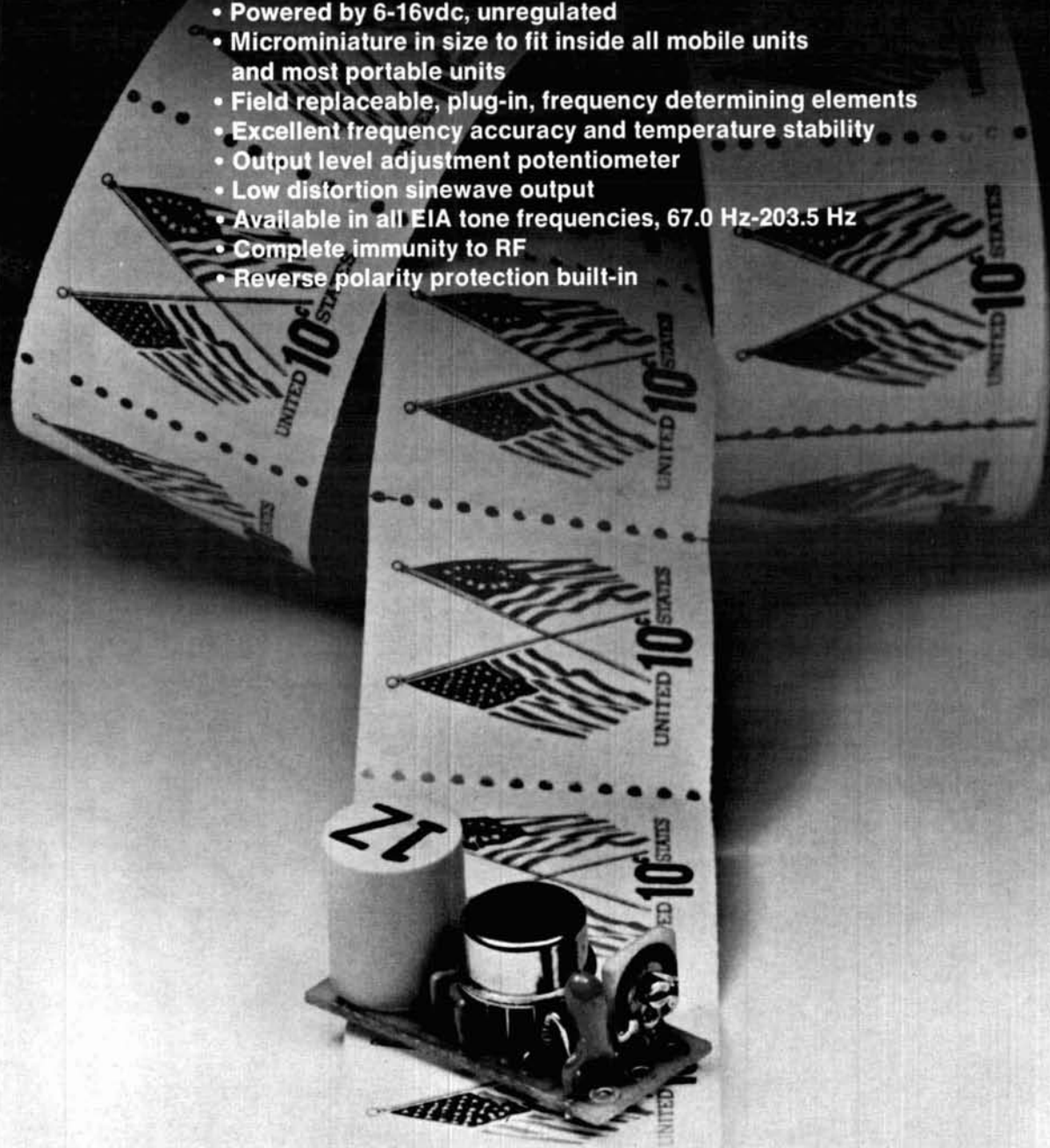

**\$29.95 each**

Wired and tested, complete with K-1 element

**communications specialists**

P. O. BOX 153  
BREA, CALIFORNIA 92621  
(714) 998-3021

K-1 FIELD REPLACEABLE,  
PLUG-IN, FREQUENCY  
DETERMINING ELEMENTS

**\$3.00 each**

# ham radio

magazine

**JANUARY 1976**  
volume 9, number 1

#### editorial staff

James R. Fisk, W1DTY  
editor-in-chief

Patricia A. Hawes, WN1QJN  
Alfred Wilson, W6NIF  
assistant editors

J. Jay O'Brien, W6GO  
fm editor

James A. Harvey, WA6IAK  
James W. Hebert, WA8OBG  
Joseph J. Schroeder, W9JUV  
associate editors

Wayne T. Pierce, K3SUK  
cover

#### publishing staff

T. H. Tenney, Jr., W1NLB  
publisher

Fred D. Moller, Jr., WN1USO  
advertising manager

Cynthia M. Schlosser  
assistant  
advertising manager

Therese R. Bourgault  
circulation manager

#### offices

Greenville, New Hampshire 03048  
Telephone: 603-878-1441

ham radio magazine is published monthly by  
Communications Technology, Inc  
Greenville, New Hampshire 03048

#### subscription rates

U.S. and Canada: one year, \$10.00  
three years, \$20.00  
Worldwide: one year, \$12.00  
three years, \$24.00

#### foreign subscription agents

**Canada**  
Ham Radio Canada  
Box 114, Goderich  
Ontario, Canada, N7A 3Y5

**Europe**  
Ham Radio Europe  
Box 444  
194 04 Upplands Vasby, Sweden

**France**  
Ham Radio France  
20 bis, Avenue des Clarions  
89000 Auxerre, France

**United Kingdom**  
Ham Radio UK  
Post Office Box 64, Harrow  
Middlesex HA3 6HS, England

**African continent**  
Holland Radio, 143 Greenway  
Greenside, Johannesburg  
Republic of South Africa

Copyright 1975 by  
Communications Technology, Inc  
Title registered at U.S. Patent Office

Printed by American Press, Inc  
Gordonsville, Virginia 22942, USA

Microfilm copies of current and  
back issues are available from  
University Microfilms  
Ann Arbor, Michigan 48103

Second-class postage  
paid at Greenville, N.H. 03048  
and at additional mailing offices

## contents

### 10 synthesized two-meter fm transceiver

Robert W. Wilmarth, W1CMR  
William R. Wade, K1IJZ

### 18 50-MHz frequency counter

James W. Pollock, WB2DFA

### 24 antenna and tower restrictions

Harry R. Hyder, W7IV

### 28 diode detectors

Henry D. Olson, W6GXN

### 36 microprocessors

David G. Larsen, WB4HYJ  
Peter R. Rony  
Jonathan A. Titus

### 42 wideband linear amplifier

J. A. Koehler, VE5FP

### 46 high gain yagi for 432 MHz

Kenneth E. Holladay, K6HCP

### 50 remote repeater control

Robert C. Heptig, KØPHF  
Robert D. Shriner, WAØUZO

### 54 basic troubleshooting

Michael James

### 60 RAM keyer update

Howard M. Berlin, K3NEZ

### 64 audio-power integrated circuits

Edward M. Noll, W3FQJ

### 4 a second look

### 102 advertisers index

### 64 circuits and techniques

### 68 comments

### 91 flea market

### 97 ham mart

### 72 ham notebook

### 76 new products

### 6 publishers log

### 102 reader service

### 54 repair bench

### 8 stop press



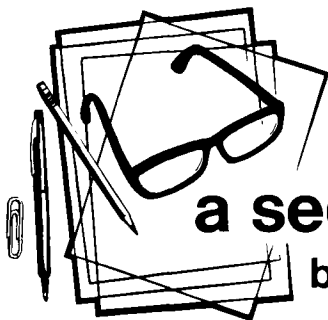

## a second look

by Jim Fisk

Although this new, larger edition of *ham radio* may seem like a nuisance if your shelves are designed for the old size, I think you'll soon discover that the advantages of the larger format far outweigh the slight inconvenience of storage problems. For one thing, the larger page size allows us to present larger schematics, so there will be less segmented drawings than there have been in the past. If you're building a project or tracing out a circuit diagram, switching from one page to another as you go through a schematic can be annoying, and often leads to wiring errors. The larger page size also means that the photographs will be larger, so you will be able to more clearly see how the author laid out his original circuit.

However the graphical advantages of the larger page size are small potatoes when compared to the big bonus of the larger format: more available space for technical and construction articles. This 104-page issue, for example, contains as much reading material as any two of our previous issues — the more than 50 pages of technical articles in this issue, if scaled down to the old size, would fill nearly 90 pages. This not only means that we've got to work twice as hard to keep *ham radio* filled with the kind of articles you want to read, it also means that we can provide more basic construction articles and tutorial material that we didn't have room for in the old format. While we will continue to publish the latest technical developments in amateur radio, the increase in editorial space will allow us to broaden our horizons to include features which will appeal to a wider audience. Some of those new features are included in this issue — others will be added in the months ahead.

One of those new features is *repair bench*, a monthly column devoted to troubleshooting your own equipment. We have had many requests for such a column but until now, because of the nearly weekly changes in modern communications technology, there simply wasn't room in the magazine. The first few *repair bench* columns will be geared to basic troubleshooting techniques, while future columns will attack such subjects as receivers, transmitters, ssb equipment, vhf fm, RTTY, logic systems, slow-scan television and much more. The column won't be written by one person, but by different authors who have proven expertise on the topic covered by a particular column. Although I have several authors already lined up, I'm looking for others with troubleshooting experience who would be interested in writing some columns. If you have suggestions for topics, or would like to contribute, please drop me a line.

The *circuits and techniques* column which we have published irregularly for the past several years will once again become a monthly feature beginning with this issue. *Circuits and techniques* will also take on a different look in the coming months as we use it as a vehicle for presenting new circuits, technical developments and construction techniques which come to our attention. If you develop a simple circuit for a special task, are using a well-known circuit in an unusual application, or run across an interesting circuit or technique in a foreign publication, we'd like to hear about it.

The popular *ham notebook* column which we've been publishing since 1968 will continue to be a monthly feature, as will the *microprocessor* column which we introduced last month. We're also looking for amateur-oriented construction projects which are built around microprocessor chips.

We have several other new features being developed which will be published in the coming months. One of these will be the *weekender*, a simple project that can be built in a few hours time over one weekend. A unique feature of the *weekender* is that we will arrange to have all components and a circuit board available from one easy-to-reach commercial source. The first of the *weekender* projects is scheduled for publication in the February issue, and we're busily rounding up future *weekender* candidates from our authors. If you have a project which you think might qualify as a *weekender*, we will be glad to consider it for publication. Suggestions for future *weekender* projects are also welcome — we may be able to place your idea in the hands of an author who can come up with a finished product.

Our editorial staff is very excited about the many possibilities of the new, larger size, and we're looking forward to making *ham radio* bigger and better than ever before. Your comments and suggestions are always welcome.

**Jim Fisk, W1DTY**  
editor-in-chief



# The First Base Hit!

The 450MHz-FM game now has one on base! ICOM is on with the first 440-450 radio built specifically for base operation, the **IC-31**. You're going to be hearing a lot from this promising young newcomer following in the footsteps of that popular veteran, the **IC-30A** mobile unit.

Impressively built for 26 channels and 10 watts output, this unit is the perfect teammate of the **IC-30A**, which has proven itself to be the biggest 450 winner on the road. With the S.W.R. bridge built right into the front panel and a forward mounted 9-pin socket, the new **IC-31** base unit provides the flexibility necessary to good UHF operation, and its compact size and styling match the other ICOM base radios.



If you want the number one team, bring it on home with the **IC-31**. Tryouts are being held at your ICOM dealer now.

Frequency Range	440-450MHz
Channels	26
Power Output	Hi 10 Watts, variable to 1 Watt
Sensitivity	.4 microvolts for 20DB quieting .3 microvolts for 12DB SINAD
Bandwidth (Transmitted)	15KHz with 5KHz deviation
Size	111x230x260 (dim. in MM)
Weight	7.2 kilos

VHF/UHF AMATEUR AND MARINE COMMUNICATION EQUIPMENT

Distributed by:



**ICOM WEST, INC.**  
Suite 3  
13256 Northrup Way  
Bellevue, Wash. 98005  
(206) 747-9020

**ICOM EAST, INC.**  
Suite 307  
3331 Towerwood Drive  
Dallas, Texas 75234  
(214) 620-2780



## publisher's log

skip tenney  
W1NLB

A look through this issue will quickly show that *ham radio magazine* is at a significant turning point in its eight year history. This is by far the biggest magazine we've ever published. Not only are the pages larger, but it also has far more editorial matter, more columns, more color and yes, even more ads than ever before.

This change is typical of what's happening throughout Amateur Radio. The whole hobby appears to be at a turning point which will lead to many changes over the next few years which could well make today's Amateur world seem quite unfamiliar.

When we started only eight years ago VHF fm was unknown to most Amateurs. Slow-scan TV was in its very infancy. Almost no Amateur gear was solid-state at the time, while digital concepts and integrated circuits were virtually unheard of in amateur work.

Now we suddenly find ourselves at a new starting point as digital techniques are coming at us in a rush led by the exciting new microprocessor chips which are scheduled to change much of our daily world as they take charge of your kitchen, automobile and workplace. It goes without saying that their effect over the next few years on even a relatively simple Amateur station will be significant.

Arriving almost simultaneously with the birth of *ham radio magazine* were the long awaited rules outlining *Incentive Licensing*, which have provided the basic framework of the Amateur licensing structure for the past seven years.

Again during the past year the Amateur community has had an excellent opportunity to debate at length another major step in our regulatory history commonly known as *Restructuring*. At this writing it appears that within the next few months these new ideas will become reality, but possibly in a very different form than originally proposed just a year ago, but definitely including the much discussed no-code license. The concept of *Reregulation* has also been introduced by Commission officials and should further influence regulations by which we must conduct ourselves.

The Amateur Radio business community has also seen many changes. Your all time high acceptance of Amateur products is permitting many exciting and useful new products to be offered which would have been out of the question just a few years ago. Attention to our advertising pages in the months ahead will show many outstanding surprises waiting for you.

Both *ham radio magazine* and *hr report* will be right there in the middle of these many exciting new developments and will bring them to you step by step as they unfold. We'll be doing our best to show you what is happening and just what can be done to insure that both you and Amateur Radio realize maximum benefit from these many changes.

Skip Tenney, W1NLB  
publisher

## GREAT PUNCH LINE

Any ALPHA Linear Will Give Your Signal  
Maximum Legal Power "Punch" . . .

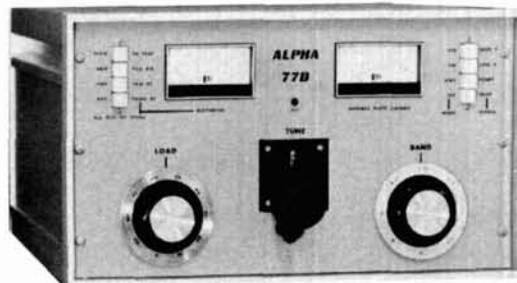

### The Ultimate — ALPHA 77D

- Ultra-conservative, super-rugged design
  - 1.8 through 30 MHz
  - 8877 Eimac Triode
  - Full QSK break-in
  - Vacuum tuning and T/R
  - Whisper quiet
  - Full year warranty
- \$2995 amateur net.

So Just Choose The Model Best Suited . . .



### No-Tune-Up — ALPHA 374

- Bandpass or manual tuning 10-80 meters
  - Maximum legal power continuous duty all modes
  - Three Eimac 8874's
  - Proven dependability
  - Full year warranty
- Immediate delivery at \$1395.

To YOUR Operating Interests And Budget!

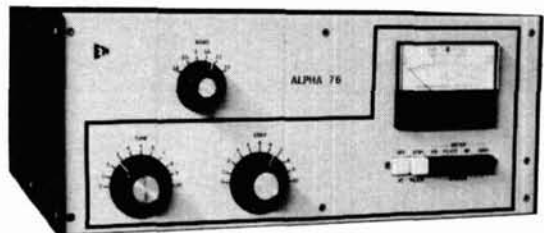

### Practically Perfect — ALPHA 76

- 2+ Kilowatts SSB PEP
  - Full KW CW/FSK/SSTV
  - 10-80M (160M only \$49.50)
  - Eimac ceramic triodes
  - Fully self-contained
  - Full year warranty
- A Robust "Cool KW" At A Practical \$895, Factory Direct

EHRHORN TECHNOLOGICAL  
OPERATIONS, INC.  
BROOKSVILLE, FLORIDA 33512  
(904) 596-3711



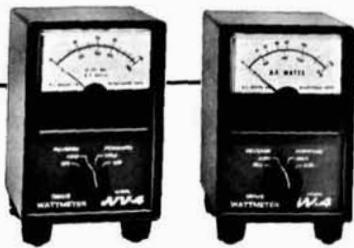

## Memo from Drake

One of our observers wrote the other day that we do some rather curious things from time to time here at Drake. For example, he said, we seem to have a penchant for putting wattmeters in almost everything.

On thinking that over, it is true that the W-4 is a fine device for up to 2 kW from 1.8 thru 54 MHz. The WV-4 covers 20 to 200 MHz and we do have W-4 type units in the MN-4 and MN-2000 antenna matching units. We also have one in the C-4 Station Console, and a 3 kW meter in the L-4B Amplifier.

Our friend went on to say since we have put so many wattmeters in various things, we had probably even put one in the coffee pot here at the plant. Now obviously that carried the whole thing a bit too far — after all, we had enough trouble getting one into the water cooler!



When R-F power needs to be measured  
consider one of the products  
from the good guys  
at Drake



**R. L. DRAKE COMPANY**



540 Richard St., Miamisburg, Ohio 45342  
Phone: (513) 866-2421 • Telex: 288-017

See us at SAROC in Las Vegas



JOHN JOHNSTON REPLACED Prose Walker as chairman of the World Administrative Radio Conference Amateur Radio working group at the group's December meeting in Washington. Prose had been a prime mover in getting this very important activity organized and going, and despite his retirement from the FCC in July had headed up its September meeting during the ARRL national convention in Reston and seemed likely to continue with it on a consultant basis with the FCC. However, the staffing and budget crunch in the Amateur and Citizens Division brought on by the CB landslide workload put a crimp into those plans so Division Chief John Johnston will be taking it over.

Though Prose' Expertise will certainly be missed, John is expected to carry the WARC preparation effort ahead with minimal interruption. Under Prose' direction the basic organization had been firmly established and the various task force chairmen and their groups moving along nicely, so the transition should be a relatively painless one.

900 MHZ AMATEUR BAND is receiving consideration both in and out of the FCC. The recent opening of 115 MHz of spectrum in that region to commercial two-way users will accelerate technical development in that frequency range, and Amateur Radio (and/or possibly Class E CB) has at least a chance to pick up a portion of the remainder.

Amateur Space And Satellite Communications would find a new band in the 900 MHz region particularly valuable — it's high enough to get away from a lot of noise and low enough that atmospheric absorption is not a problem. The possibility has already been explored in WARC meetings and a proposal for such a band will probably become a WARC group recommendation.

OSCAR 7 is being seriously affected by users putting signals much stronger than needed into it on Mode B. Overloading is causing excessive battery discharge and may be responsible for mode switching and shutdowns. Area coordinators and others are asked to watch for signals causing "pumping," report calls of offenders to W3HUC c/o AMSAT and advise those nearby of their abuses.

Demonstrating Mode B Sensitivity, W6CG made over 20 contacts in one week running 500 mW to a dipole antenna! Bud's QSOs included Hawaii and Maryland.

REPEATER CROSSBANDING, DOCKET 20113, has been approved and became effective December 15. Report and order will permit unlimited crossband operation of repeaters in the authorized repeater subbands, covers several related topics.

Definition Of "Automatic Retransmission" has been added to the rules, characterizes an "automatic retransmission" as one initiated by a received signal. Automatic retransmission is restricted to repeaters, auxiliary links or remotely controlled stations such as a remote base which has an auxiliary link station as a part of its system. In the latter case, the remote base is limited to retransmitting the signals of its auxiliary link station only.

PAPERWORK FOR REPEATERS and other remotely-controlled Amateur stations will be simplified greatly by an FCC action adopted in November. As of December 1, technical showings will no longer be a required part of the license application for such a station and technical information will be required only as part of the permanent station log. Repeater license applicants, for example, need only specify that their proposed station will be remotely controlled. System block diagrams, control details and the like need not accompany the application but must be entered in the permanent station log. Similarly, repeater-control stations will not even need to specify what repeater they intend to become a control station for — that's entered in their control station log and the log of the repeater they control.

Net Result of this important change is to speed up license processing greatly since technical evaluation will no longer be a part of the license granting procedure.

Note That All Information previously required as part of the FCC file record is still required in the permanent log. This is spelled out in new Part 97.103b, which replaces 97.41c and 97.41e. Control station requirements are spelled out in new Part 97.103d.

Prohibition Against Portable Or Mobile operation of a remotely controlled station in Part 97.88e has also been deleted. However, during portable or mobile operation a positive control system is still required and the usual requirements for ID, logging and notification must still be observed. Note too that the prohibition against portable or mobile operation of auxiliary link stations has not been relaxed.

REPEATER AND CLUB STATION TRUSTEES should be aware that group organization plans and constitutions are being checked by FCC legal people to be sure funding of group Amateur stations is not in violation of Part 97.112. All new applications are checked as a matter of course, and files on old licenses are sometimes pulled for review on a random basis. Groups whose fund raising systems seem to ask money for operation or use of the station are very likely to be cautioned.

BICENTENNIAL PREFIX LIST in last May's Presstop had a typo which should be corrected. WNI-WNØ can use AK1-AKØ — not AG1-AGØ as shown. Use of the alternate bicentennial prefixes is entirely optional, but remember that they don't go into effect until 0500Z January 1, 1976, and are good until January 1, 1977.

ALL IRCs IN CIRCULATION will be honored for first class overseas postage regardless of date of issue through the end of 1976, according to latest post office info. After that all earlier IRCs will be void and only latest issue will be valid.

CANADA GOES AFTER IGNITION NOISE with a new Radio Interference Regulation that takes effect next September 1. The new regulation will severely limit the permissible radiation from any spark ignition engine, includes autos, chain saws and snow mobiles, with the one exception of aircraft engines. The regulation will eventually be extended to include other RFI sources such as power tools and high voltage transmission lines.

# American Ham Spirit, you either have it; or you don't.

The hams at Dentron have it. That's why we pack so much excitement into the products we build.

If you're an excited ham who loves to operate all bands, why not complete your station with the 160 meter Top Bander™? 160 meters is only a step away from 80 with this remarkable 160 meter transverter. Designed to bring simple, low cost 160 meter capability to any amateur station equipped for 80 meter CW, SSB, or AM operation. Just "plug in and play" and you're on 160 meters with 100 watts transmit power and a super sensitive receiver.

And coupled with the 160AT Skymaster™, tuning your present antenna or long wire is a snap.

There is only one Super Tuner™ and only one Super Super Tuner™. Excited Dentron customers around the world have discovered why the Super Tuner™ and Super Super Tuner™ are the only antenna tuners on the market that will match **EVERYTHING** between 160 and 10 meters, whether it be balanced line, coax cable, random or long wire.

For the ham on the go the 80-10 Skymaster™ offers portability for tuning that random or long wire antenna. With Dentron Skymatcher™ you don't have to miss out on the fun of ham radio if you live in a motel or condominium.

Its Finally here! The Dentron Dual, In-line Watt meter. If you're a perfectionist as we are, you have certain requirements for your station. Naturally you'll want to monitor both forward and reflected wattage simultaneously. Tired of constant switching and guesswork? Upgrade!

- Reverse scale 0-200 watts
- Forward scale 0-200 and 0-2000 RFWatts
- Meter accuracy  $\pm 5\%$
- Frequency coverage — 1.7 through 30mcs.

Dentron manufactures antennas because our customers deserve better performance. There have been too many compromise antennas for too long. We know how much time the average antenna takes to assemble, that's why we do the work before we ship to you. What a Dentron antenna **DOES NOT** include is 2 large plastic bags of parts, 5 pages of instructions and many hours of assembly.

With the Skymaster™, Skyclaw™, Mobile Topbander™, all band doublet and new Trim-Tenna™ 20 meter beam, you'll be proud of their fine appearance and performance and thrilled with the few minutes it takes to assemble them.

## CATCH THE EXCITEMENT FROM DENTRON . . .

all Dentron products are made in the USA.  
From Dentron Radio or your Favorite Dealer.



160XV  
Top Bander \$199.50 ppd. USA  
2 MHz MARS unit  
\$229.50 ppd. USA



160AT Skymatcher  
\$59.50 ppd. USA



160-10AT Super Tuner \$119.50 ppd. USA



160-10AT  
Super Super Tuner  
\$229.50 ppd. USA



W-2 Wattmeter  
\$99.50 ppd. USA



80-10AT Skymatcher \$59.50 ppd. USA



**Dentron**  
Radio Co., Inc.  
2100 Enterprise Parkway  
Twinsburg, Ohio 44087  
(216) 425-3173



## synthesized two-meter fm transceiver

Frequency  
heterodyne techniques,  
synthesizer modulation  
and modular construction  
are combined  
in this novel design

This article describes a two-meter fm transceiver containing a 400-channel frequency synthesizer. The transceiver is designed to operate from a 12-volt dc source. By using heterodyne techniques rather than frequency multiplication, only one frequency at a time is generated by the synthesizer, which is used for both transmit and receive modes. Lock-up problems are avoided by eliminating the need to generate the offsets in the synthesizer. With the heterodyne scheme, the synthesizer changes frequency directly in 10-kHz increments, which greatly simplifies its design; you need only dial in the desired transmit frequency along with the desired receive mode. The receiver offset,  $\pm 600$  kHz for repeater or zero kHz for simplex operation, is generated by a separate crystal-controlled oscillator. An interesting feature of the transceiver is that the modulation is applied directly to the synthesizer, which results in excellent-quality audio with simple circuitry.

### general description

Fig. 1 shows the functional elements. The synthesizer tunes from 12.01 to 16 MHz in 10-kHz steps. Modulation is applied directly to the voltage-controlled oscillator (VCO) control line from a clipper preamp. In the receive mode, the clipper preamp is disabled by switching the B+ line. The VCO output is buffered after which the signal is split and fed to two double-balanced mixers,

By Robert W. Wilmarch, W1CMR, and William R. Wade, K1IJZ, Roberts Road, Wellesley, Massachusetts 02181

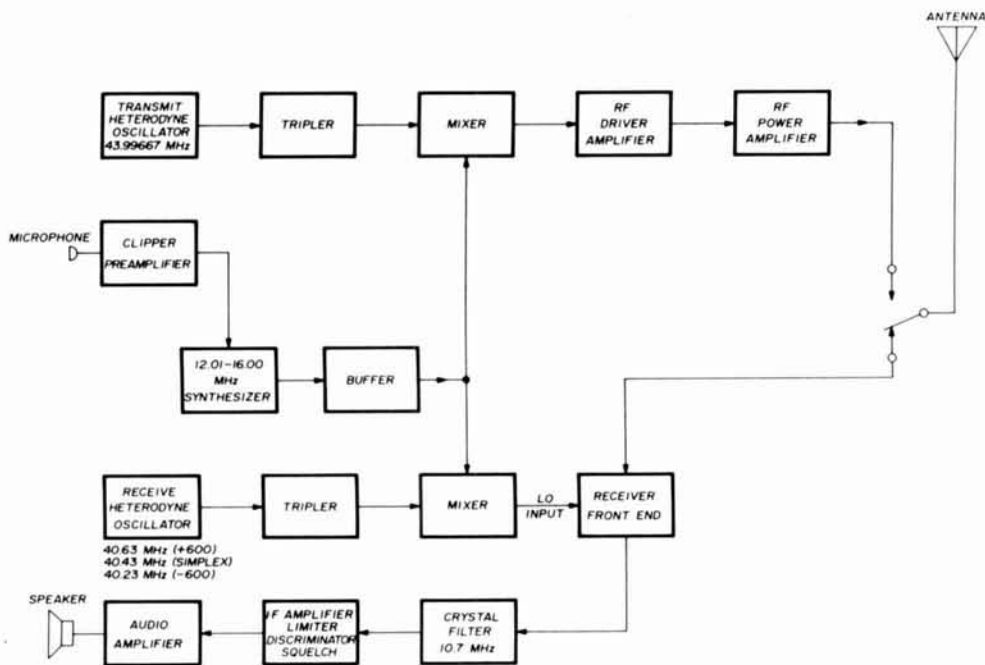
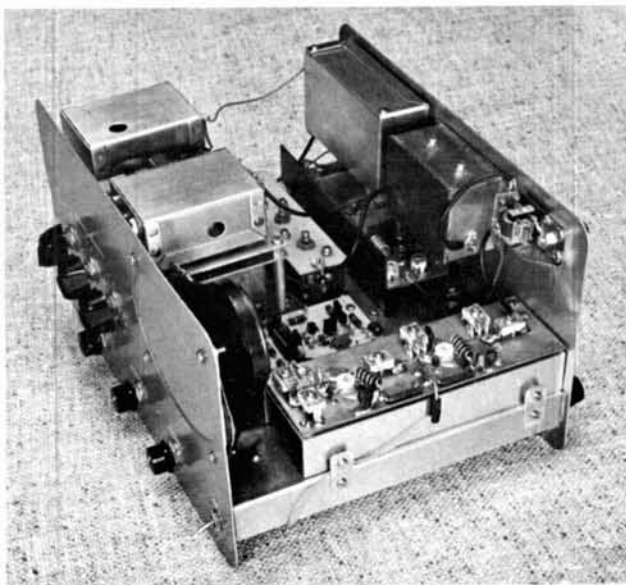

fig. 1. Block diagram of the synthesized 2-meter fm transceiver.

one in the transmit line; the other in the receive line. In both cases the synthesizer signals are fed into the local oscillator (LO) ports of the mixers.

In the transmit mode a signal at 131.99 MHz is added to the synthesizer signal so that the resultant signal covers 144 to 148 MHz. The front-panel controls are marked to indicate the transmit frequency. The mixer output is fed into a driver amplifier where the signal level is raised to about 2 watts. This signal in turn drives a 15 to 20 watt power amplifier. In the receive mode the transmit heterodyne oscillator and mixer stage are disabled through the B+ line. Voltage is left on the driver and power amplifier stages since these stages are run in

**Overall view.** The audio amplifier and optional power amplifier are shown immediately behind the speaker.



class C and consume negligible power without drive.

On receive, the synthesizer signal is mixed with one of three crystal-controlled frequencies depending on the desired operating mode. The resulting sum frequency is the LO frequency required to heterodyne the receive frequency to the (nominal) 10.7 MHz intermediate frequency. This i-f signal is fed through a crystal filter which determines receiver selectivity. The circuits following the filter are conventional. In the transmit mode only the audio amplifier is disabled, again through the B+ line. Two small relays are used. One switches the antenna from receive to transmit. The other, in the B+ line, turns various circuits on and off as described above. A double-pole, double-throw relay may be used for switching.

### synthesizer

The synthesizer generates frequencies between 12.01 and 16.00 MHz in 10-kHz steps. During transmit this output is heterodyned with a 131.99-MHz signal to produce transmit frequencies between 144.00 and 147.99 MHz. On receive, the required LO frequency is obtained by heterodyning the synthesizer output with either 121.29 MHz for simplex operation, 121.89 MHz for normal repeater operation, or 120.69 MHz for reverse repeater operation. Because of the heterodyning scheme, this synthesizer is simplicity itself. It requires none of the 1-count detectors, out-of-lock detectors, or count offset circuits of synthesizers used in multiplier service.<sup>1</sup>

Above 7 MHz the programmable divider chain of SN74192s swallows a count due to propagation delays. This action causes a 1 count (10 kHz) offset in the synthesizer output frequency from that to which the divider is set. This offset is compensated in the heterodyne process to yield the correct transmit or LO frequency with respect to dial setting at the mixer output.

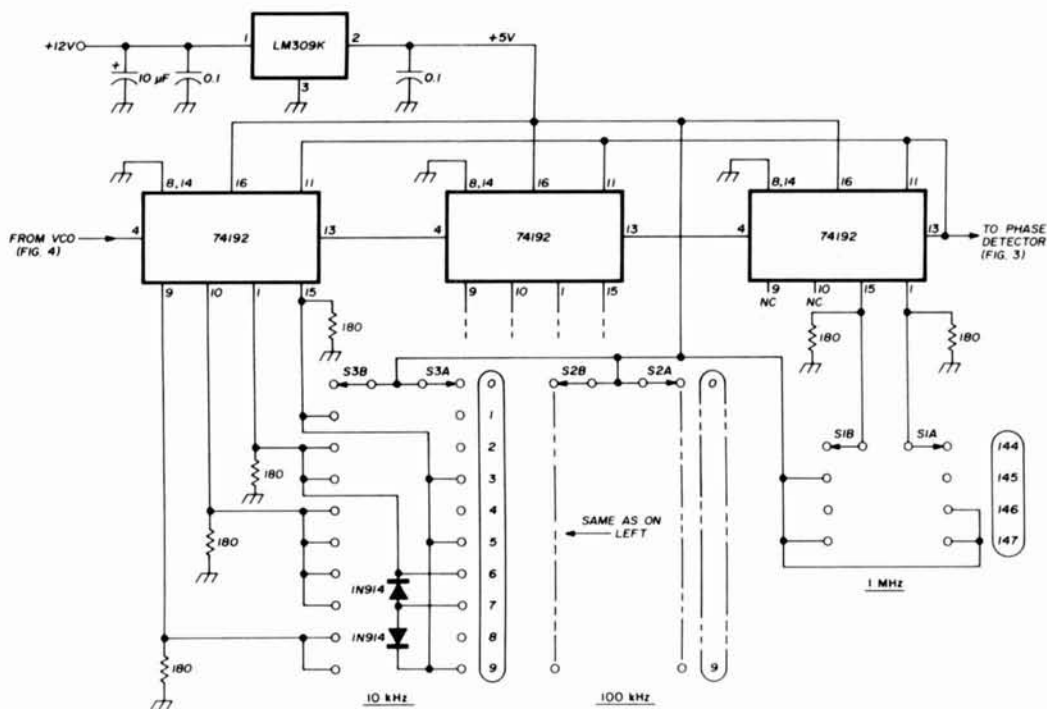
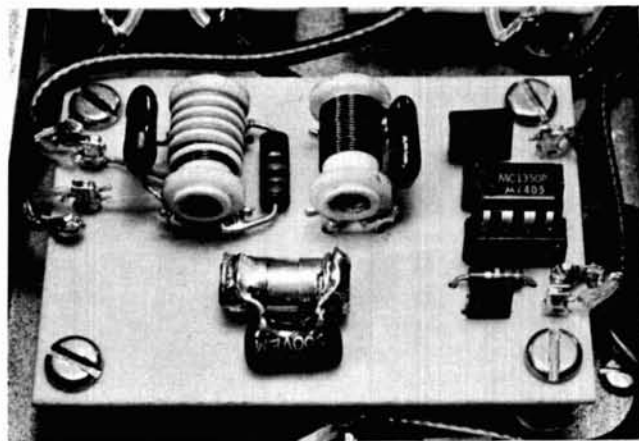

fig. 2. Programmable divider.

The programmable divider, fig. 2, is unique in that the  $\div 12$  through  $\div 15$  functions are obtained from a single decade counter chip. This bit of magic is accomplished by using the last 74192 as a downcounter, which is preset to a 12, 13, 14, or 15. The decade limitation on the 74192 holds only in an upcount mode. The other two counters are presettable from 0 to 9, and the string of three 74192s divides the VCO frequency by a number between 1201 and 1600 with the programmed inputs set between 1200 and 1599.

The phase detector and filter, fig. 3, are straight from the MC4044 data sheet with an extra capacitor on the filter output to help suppress the 10-kHz ripple on the VCO control line. Adjustment of the 10k pot in the filter is accomplished by listening to the VCO on a



Synthesizer buffer amplifier.

Top of synthesizer showing, left to right, phase detector and filter; VCO, and reference oscillator.

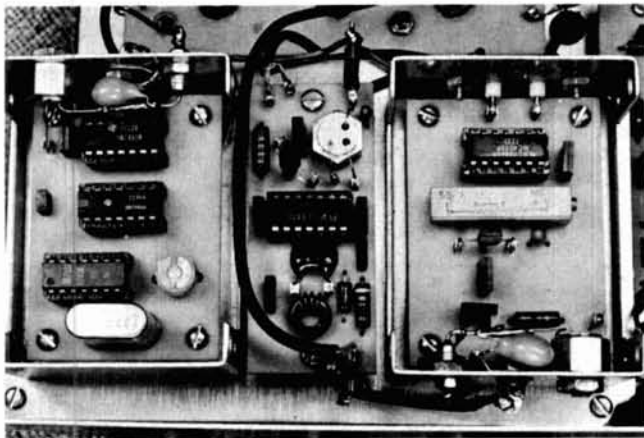

receiver, tuning 10 kHz off to find a VCO sideband and tweaking the pot for minimum sideband signal.

The VCO, fig. 4, is an LC oscillator using the MC1648 as the active element. This circuit proved superior in performance to any of the available multivibrator type VCOs. Watch out for the MV1401! It's an expensive (\$9) wide-range varicap, and again it proved superior to the less-expensive diodes. A glance at the synthesizer schematics shows that the phase detector, reference oscillator, programmable divider, and VCO each has its own LM309 5-volt regulator. A regulator is mandatory in phase-locked loops to decouple the circuits from each other. Any modification of this decoupling scheme should be avoided. Usual RC and LC decoupling techniques do not compare with the use of three-terminal regulator ICs.

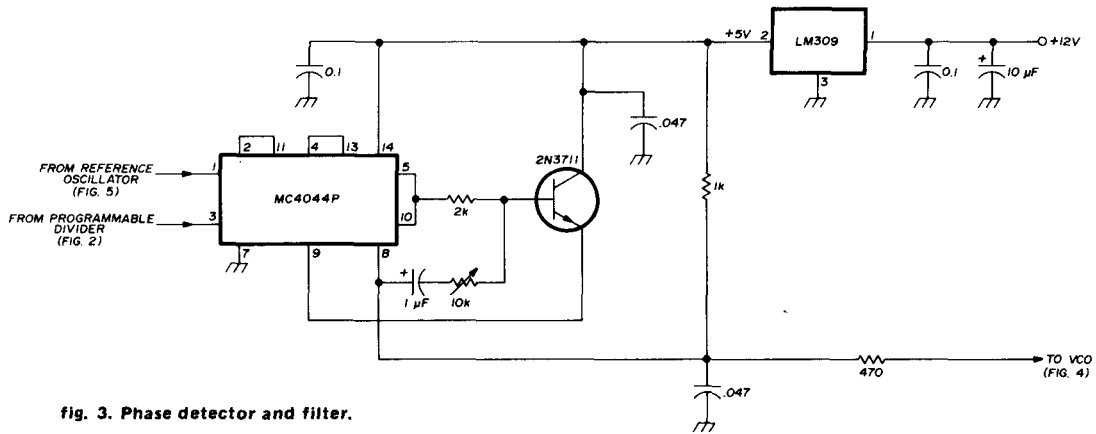

fig. 3. Phase detector and filter.

The programmable divider is constructed on double-sided board with the wiring side at ground and the component side at +5 volts. The  $V_{CC}$  pins of the IC sockets are bent out and soldered directly to the 5-volt side, while the ground leads are brought through the boards and soldered directly to the foil. This approach provides a low impedance  $V_{CC}$  line, which prevents possible erratic synthesizer behavior.<sup>2</sup>

The reference oscillator, fig. 5, is a 1-MHz crystal oscillator followed by two decade dividers to yield the 10-kHz reference frequency. The synthesizer output is buffered as shown in fig. 6. A double-tuned output circuit provides a flat response over the full 4-MHz range. A single-tuned output stage will suffice if the transceiver is set up to operate over a 2-MHz range. In this case the MHz switch may be replaced with a single-pole, single-throw switch.

From the VCO buffer amplifier the signal is split and fed to two separate mixer stages. These stages, (fig. 7), are identical except for minor differences in the tuned circuits. In each case, the stage is used to add the synthesizer output to that of a heterodyne oscillator. In one case the sum frequency is the transmit frequency, while in the other it is the receive LO frequency. Double-balanced mixers are used because they happened to be available. Suitable mixers may be built<sup>3</sup> or purchased for about \$7.00 new and perhaps for considerably less on the surplus market. A mixer stage using a dual gate

40673 mosfet was tried with apparently satisfactory results; however, the suppression of the other mixing product was not verified. Other approaches should work equally well.<sup>4</sup>

Care was taken to provide 50-ohm terminators to each mixer port. The synthesizer buffer is fed into the LO port, and with the coupling arrangement shown, the buffer provides an LO signal of +7 dBm. The heterodyne oscillator signals were adjusted by varying the position of the output links so that the power at the mixer was near zero dBm. These adjustments did not appear to be critical. By using an in-line layout for the mixers, no instabilities were encountered.

The receive mixer stage is powered at all times, while the transmit mixer stage and its heterodyne oscillator are powered only during transmit, which is necessary to prevent a receiver birdie in the simplex mode.

### modulator

The first attempts at modulating the transmitter were along conventional lines; the modulating voltage was applied to a tuning diode in the transmit heterodyne oscillator crystal circuit. While this method worked, the audio quality left something to be desired. After a number of attempts to improve matters, this approach was abandoned in favor of directly modulating the VCO in the synthesizer. The results were indeed gratifying, with reports of excellent audio quality. Full deviation is

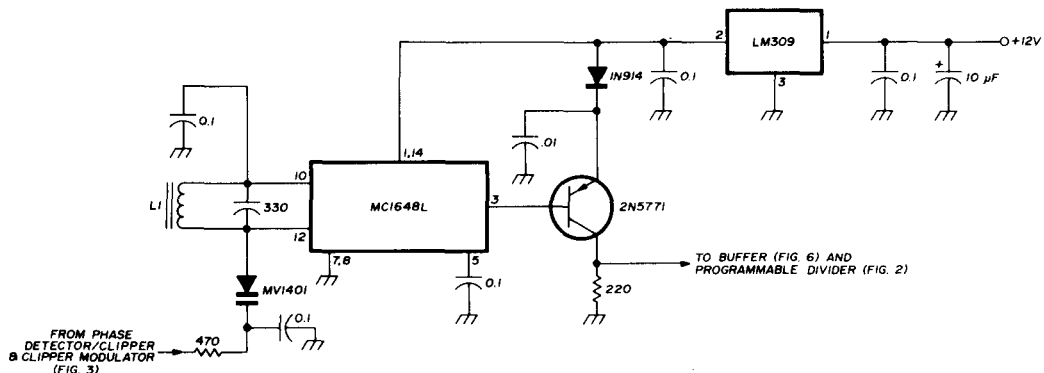

fig. 4. Voltage-controlled oscillator. L1 is 4 turns on Amidon T50-6 toroidal core.

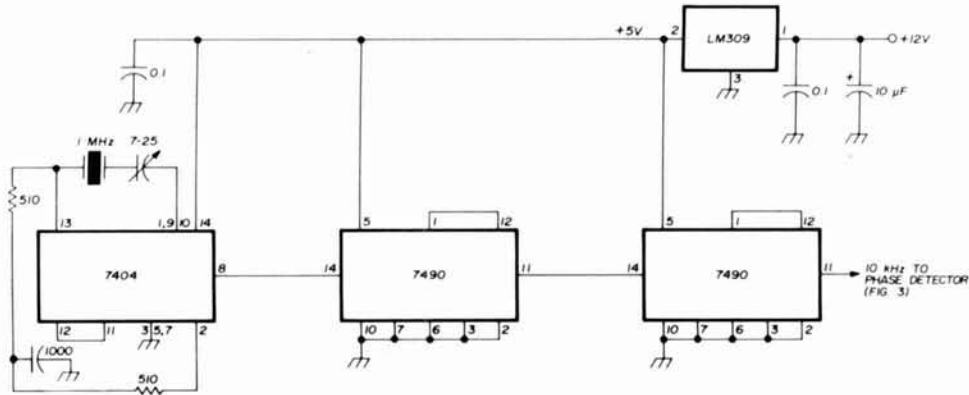
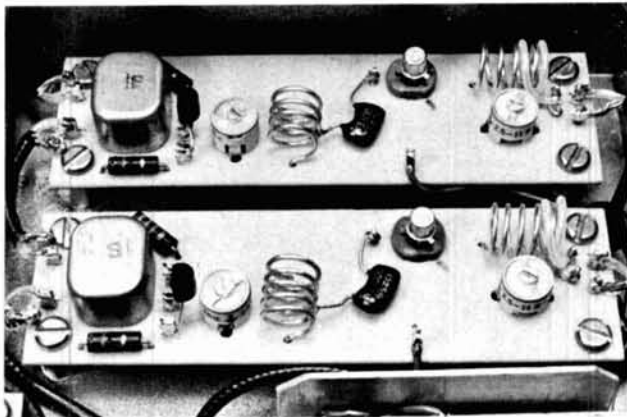

fig. 5. Reference oscillator.

obtained with only a few millivolts of modulation superimposed on the VCO line. This signal level is many times below that required to disturb the phase-locked-loop stability.

The clipper preamp, (fig. 8) is a modification of a circuit originally designed to modulate a tuning diode<sup>5</sup>



Transmit and receive mixers.

where several volts of modulation were required. Since only millivolts are now required, the output stage was changed to a simple emitter follower, eliminating several components.

### heterodyne oscillators

The heterodyne oscillators are shown in figs. 9 and 10. The circuits differ only in the number of crystals and

the addition of a zener regulator in the transmit oscillator. Overtone crystals in the 40-MHz range are used. The second stages are conventional triplers using a mosfet to minimize oscillator loading. Tripler stage output is through a one-turn link.

During tuneup, remember that a final frequency is the sum of the synthesizer frequency and that of the heterodyne oscillator. The reference oscillator should be adjusted first, then the transmit heterodyne oscillator, to produce the desired output transmit frequency. A frequency counter is recommended for this procedure. The receive heterodyne oscillator crystals should be adjusted by tweaking their series capacitors for best received audio.

### receiver front end

The receiver front end (fig. 11) is similar to a circuit described in 1968.<sup>6</sup> Only minor changes were made in the rf and mixer stages. The original fets were replaced with 40673s, and the mixer output matches a crystal filter. Gate-protected fets eliminate the need for diodes at the antenna. With gate protection no special precautions are necessary in handling these transistors; however, the 3N128 is not protected and care must be exercised. The mixer output impedance is determined primarily by the resistor across the output tank and is chosen to match the crystal filter.

The front end and i-f stages show a direct connection to the crystal filter. This is fine if the physical layout is close and there is no dc return in the filter. If a dc return is present, a blocking capacitor must be used to prevent

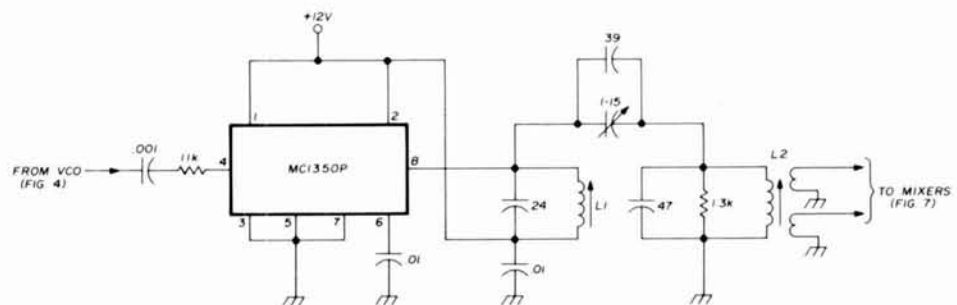
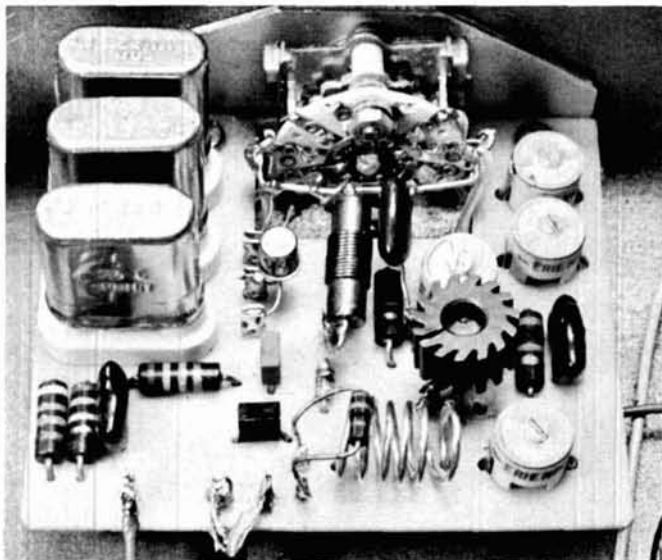
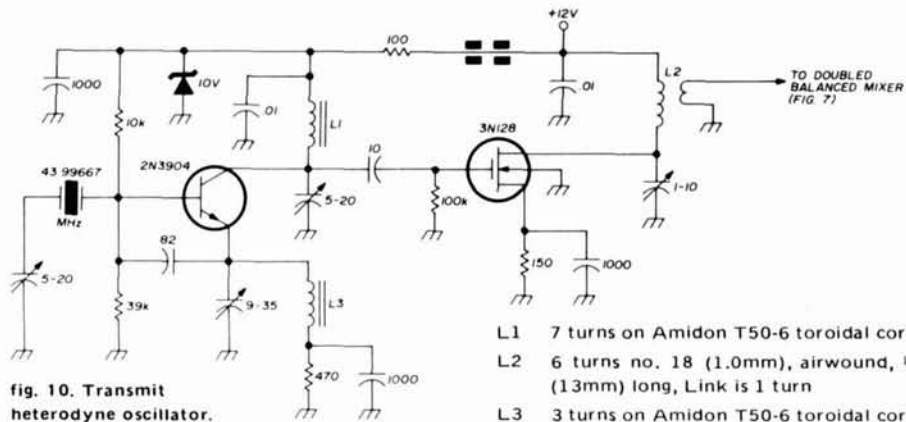

fig. 6. Synthesizer buffer amplifier. L1 and L2 are 20 turns no. 28 (0.3mm) on 1/4" (6.5mm) form. Output links on L2 are each 5 turns.







Receive heterodyne oscillator.

determines, to a great degree, the level of recovered audio. The RCA test results<sup>7</sup> were for a Q of 120. Using an available core, a value of 220 was measured, which resulted in somewhat more recovered audio. This value of Q, however, was reduced to a value consistent with the sensitivity of the audio amplifier by simply padding the coil with a suitable resistor. The effect is to greatly reduce the sensitivity of the circuit to temperature changes. Stability of this stage may be checked by looking at pin 9 with an oscilloscope. If the circuit is oscillating, a square wave will be seen.

A 2N3819 junction fet matches the crystal filter to the CA3089E. Because of the very high input impedance of this transistor, the filter load resistor from gate to ground is chosen according to the requirements of the filter. Stage gain isn't critical and need not be more than necessary to overcome the filter insertion loss. Any audio stage with sufficient sensitivity may be used. The MFC9020 is a 2-watt amplifier requiring only 200 millivolts of drive.

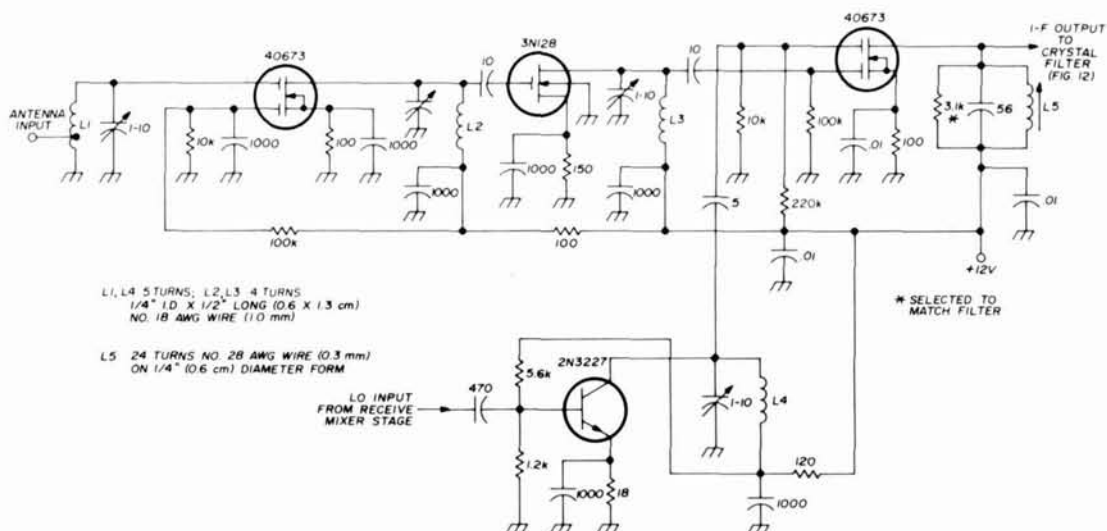

L1, L4 5 turns no. 18 (1.0mm), airwound, 1/4" (6.5mm) ID, 1/2" (13mm) long

L2, L3 4 turns no. 18 (1.0mm), airwound, 1/4" (6.5mm) ID, 1/2" (13mm) long

L5 24 turns no. 28 (0.3mm), on 1/4" (6.5mm) slug-tuned form

fig. 11. Receiver front end.





## six digit 50-MHz frequency counter

A frequency counter has several advantages over a frequency standard. Instead of listening and tuning for crystal-oscillator harmonics on a receiver, a counter can provide a direct readout in frequency from the signal being measured. An instrument such as this can be a very valuable asset for the amateur who likes to build his own variable-frequency oscillators, transmitters, and receivers. With this frequency counter I was able to align a homemade crystal filter for an ssb rig, using the counter to pinpoint the exact location of the filter passband. When the counter is used with signal generators, precision alignment of amateur equipment is a snap.

The frequency counter described here and shown schematically in fig. 1 is designed for use in the hf spectrum to 50 MHz, with a signal at the input having an amplitude of about 50 mV rms. The digital readout displays the frequency in kHz with resolution to the nearest 100 Hz. Construction cost of the counter is about \$50 including the power supply and cabinet. The cost will be lower if the ICs are in your goodie bin. Printed circuit boards are not available for this project. The entire counter, with the exception of the power supply, was built on perfboard — the kind with holes on a 0.1-inch (2.5mm) grid.

The goal of this article is to present a working design for a high-performance instrument that requires a minimum of ICs. However, I'd like to offer some observations based on experience with the project. I've noticed that the 50-MHz response is largely device-dependent. I had to select SN74S00 devices to get the counter to squeak up to 50 MHz. The ICs used in the counter were obtained from Poly Paks, as was the SN74196 decade counter. With the prescaler circuits published in *ham radio*<sup>1,2,3</sup> the counter should work well into the 432-MHz range.

The heart of the counter is a crystal-controlled oscillator. This 1-MHz source is a free-running multivibrator made up of two NAND gates (U1A and U1B) with a crystal as the frequency determining element. The 220-ohm resistors bias the gates in a class-A amplifier condition so that the oscillator is self starting and sustaining. The remaining two gates in the quad NAND package are used as buffers to isolate the oscillator from the loading effects of the IC stages that follow. U1D provides a buffered 1-MHz output to a BNC jack on the rear panel of the counter. The 1-MHz output is a very close approximation of a square wave, rich in harmonics, and provides a means of checking the oscillator with WWV. It also can be used for checking out the counter itself. If the 1-MHz output is coupled to the input jack, the counter will display 1000.0 kHz. The trimmer capacitor in series with the crystal is used in the zero beating process.

The frequency counter performs by sampling the input signal for a finite period of time. For example, if we were to couple a 1-MHz signal to a chain of decade counter stages for exactly one second, then 1 million pulses will have been counted. If the sampling time is reduced two orders of magnitude to 0.01 second, then the counter will register 10,000 pulses. Thus if 10,000 pulses are counted for each 1 MHz, the least-significant digit on the counter would represent 100 Hz. It's easy to see the importance of having a device that will perform the function of gating the unknown frequency with great precision.

The time-base divider chain is composed of four cascaded decade counters (U2-U5) followed by a flip-flop

By Jim Pollock, WB2DFA, 6 Terrace Avenue, New Egypt, New Jersey 08533

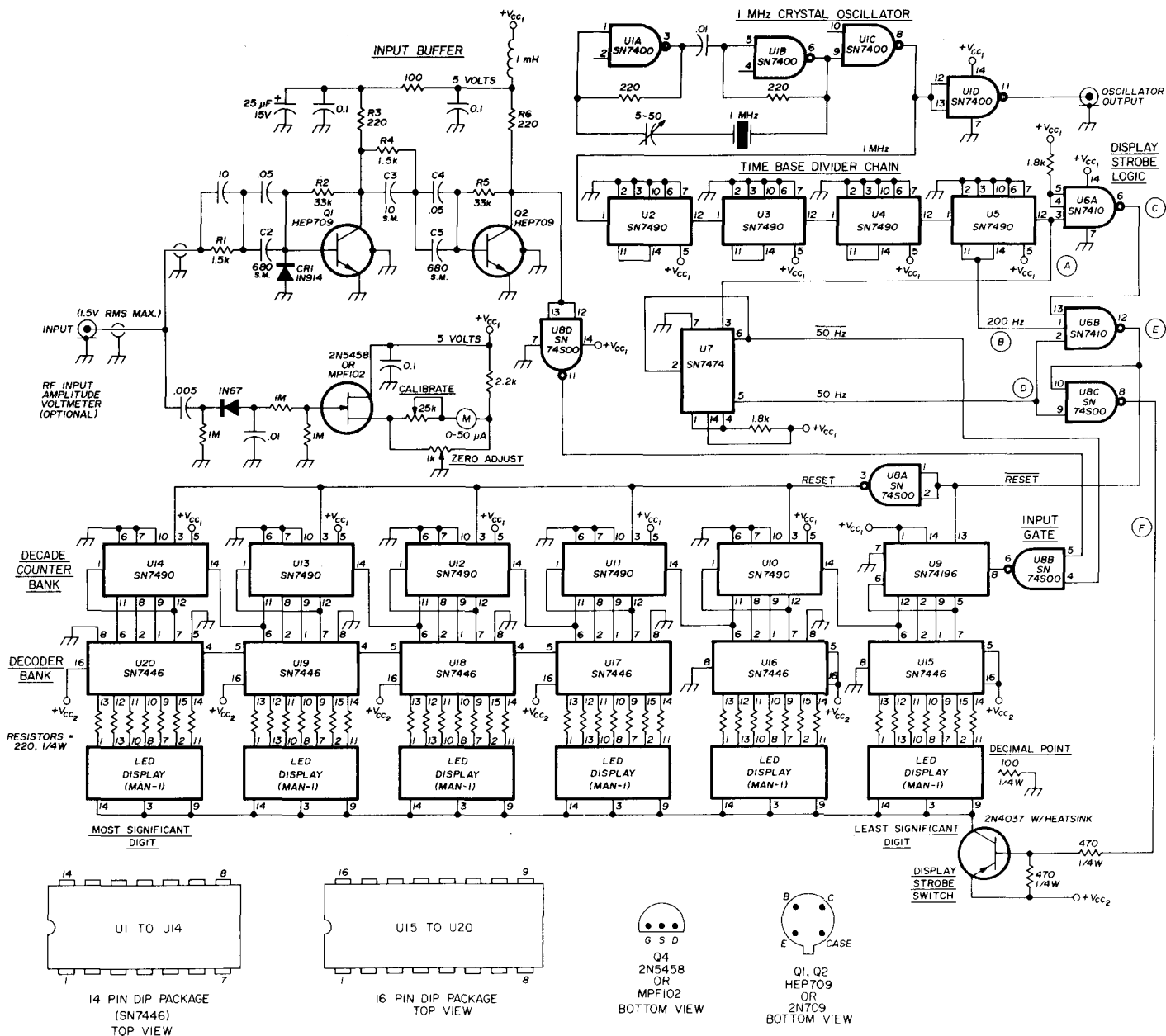

fig. 1. Frequency counter schematic.

(U7) that divides the crystal oscillator down to a frequency of 50 Hz. The flip-flop has two oppositely phased outputs, 50 Hz and 50 Hz. The 50 Hz output is 180 degrees out of phase with the 50 Hz output. Each output is a symmetrical square wave that is logic 1 for 10 milliseconds, and logic zero for 10 milliseconds, for a total time period of 20 milliseconds. The 50 Hz from flip-flop U7 controls the input gate (U8B). U8B will only pass the amplified input signal from the unknown source when the 50 Hz at pin 4 of U8B is logic 1. Thus U8B gates the unknown frequency for 10 milliseconds.

The decade counters in the time-base divider chain are connected in a divide-by-5, divide-by-2 configuration. The output frequency of each decade counter is 1/10 the frequency of the input. The output of each decade counter is a symmetrical square wave. The sche-

matic of fig. 2 shows in detail how the decade counter functions when connected in this fashion.

### display strobe logic

The display strobe logic (U6, U7, U8) synthesizes the timing sequence for sampling the input frequency, resetting the decade counter bank before each sampling period, and strobing the LED displays once for each completed sampling period. The timing diagram, fig. 3, illustrates the relationship between these signals. "F" is derived from the output of U8C, pin 8. The total time period for F is 20 milliseconds, which is determined by flip-flop U7, as discussed earlier. The duty cycle of F is determined by gating the B, C, D, and E signals together. You'll note that F is high for 11 milliseconds and low for 9 milliseconds, and that the displays are blanked out

during this 11 milliseconds of each sampling cycle. The display strobe switch, Q3, is held in cutoff as long as F is logic 1.

The  $\overline{\text{RESET}}$  pulse, E, goes low for the first 1 millisecond of the sampling cycle resetting decade counter U9 to the 0000 state. E is inverted by U8A to provide the proper reset signal for the remaining decade counters (U10-U14).

During the 10 milliseconds that follow the trailing edge of E, the input frequency to be counted is registered by the decade counter bank. The LED displays are

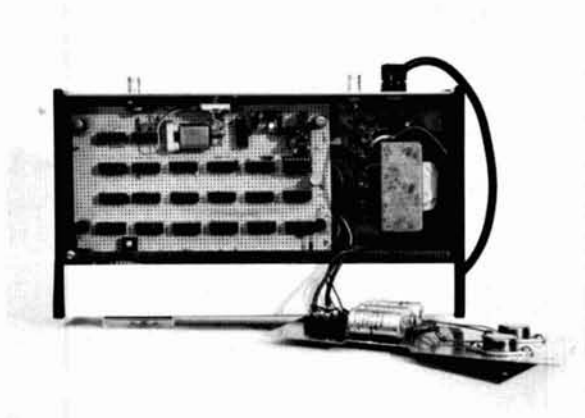

Logic circuitry for the 50-MHz frequency counter is built on a section of perf-board. Voltage regulator ICs are mounted on aluminum panel which is sandwiched above the perf board on standoffs.

blanked out during the count-up cycle; otherwise, the displays would show a blur of 8s from the fast count rate. When the sampling has been completed, the input gate is opened, and the decade counter bank no longer receives pulses from the input buffer. At this point in time F goes low; Q3 is switched into saturation, and the LED displays indicate the results accumulated during the sampling period. This process is repeated 50 times per second. Because of the persistence of the human eye, the displays seem to be on continuously. Since the counter gets an update 50 times per second, the counter will follow rapid changes in frequency, such as those encountered when tuning across the band. The counter will update changes in frequency with no apparent time lag.

### decade counter bank

The decade counter stages (U9-U14) are cascaded in a manner that allows them to function as a system for counting a series stream of pulses. U9 is the most important link in the counter chain and is an SN74196, a high-speed device capable of performance in the 50-MHz region. The SN7490 decade counters are rated at 15 MHz. Therefore, the frequency range is very dependent upon the input buffer and the SN74196. Since U9 will operate at 50 MHz, the frequency propagated to the next stage will be, at most, 5 MHz. Each succeeding stage will receive decreasing orders of magnitude of the frequency presented to U9.

The SN7490s are connected in a divide-by-2, divide-by-5 format for use in the decade counter bank. Pin 14

is used as the clock input, and the output of the first flip-flop (pin 12) is connected to pin 1 to drive the divide-by-5 portion. The counting function is performed in the binary coded decimal format. Pin 3 is used as the reset input for initializing the decade counters to the 0000 state. A logic 1 at this input will reset the SN7490. When pin 3 is logic 0, the SN7490 advances into each succeeding count state as dictated by the clocking signal at pin 14.

The SN74196, on the other hand, is nothing more than a super-fast SN7490 and operates in much the same manner. The subtle differences are in the pin configuration and the resetting scheme. Unlike the SN7490, the  $V_{CC}$  and ground pins on the SN74196 are 14 and 7 respectively; on the SN7490, they are 5 and 10 respectively. Pin 13 on SN74196 is the reset input; a logic 0 at this input will jam the counter into the 0000 state. The counter can only advance when pin 13 is logic 1. This one criterion is opposite that of the SN7490. NAND gate U8A solves this dilemma by providing oppositely phased reset signals for U9 and the remaining counters in the decade counter bank.

### decoder bank

U15 through U20 are BCD-to-seven-segment-decoder ICs. These SN7446s translate the BCD information from their respective decade counters to form digits in the seven-segment format. The SN7446s feature leading-zero blanking, which is employed to eliminate any ambiguity caused by one or more zeros preceding the most-significant digit. For example, a frequency of 00142.7 kHz is more recognizable when presented as 142.7 kHz. Blanking out the unnecessary zeros makes the display much easier to read. Special logic is designed into the SN7446 to provide this feature. The ripple blanking logic looks for a logic 0 from the ripple blanking output (RBO) from the next most-significant digit. This condition occurs when the next most-significant digit above that one is also a zero. The ripple blanking signal propagates from the most-significant digit to the least-significant digit desired in the zero blanking scheme.

If you refer to **fig. 1**, you'll notice that the ripple blanking originates from U20 (the most-significant digit) and is passed down the line to U17. The ripple blanking output (RBO) appears at pin 4 of U20 and is fed to the ripple blanking input (RBI), pin 5 of U19, and so on.

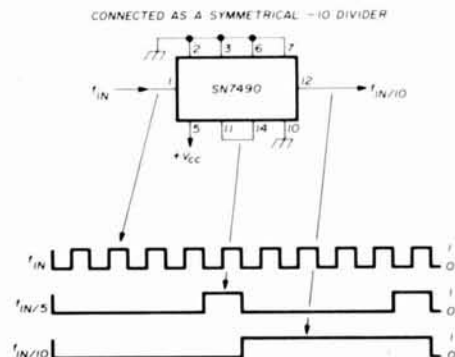

fig. 2. The type SN7490 connected as a symmetrical divide-by-10 counter.

Pin 5 of U20 is grounded since the ripple blanking process originates at U20. The ripple blanking feature can be disabled by simply connecting pin 5 on U20 to +V<sub>CC2</sub>. Pin 5 (RBI) on U15 and U16 are tied to +V<sub>CC2</sub>; therefore, with no signal present at the input gate the counter will display only the least two significant digits as zeros.

Unlike the other ICs in the project, the SN7446s are enclosed in a 16-lead dual in-line package. Pin 16 is the +V<sub>CC</sub> input and pin 8 is ground. The output pins, 9 to 14, are open-collector outputs capable of sinking 20 mA

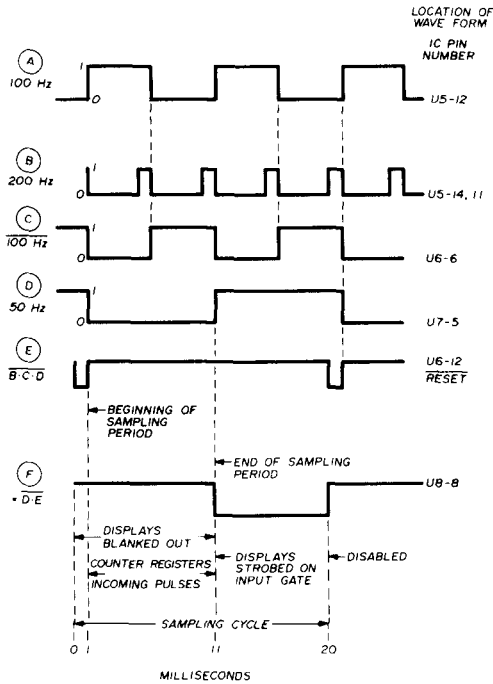

fig. 3. Timing diagram showing display strobe logic, reset, and input gating.

when switched on. The 220-ohm resistors in series with each segment on the LED displays limit the current to a peak value of 15 mA per segment. However, since the displays are strobed on for 9 milliseconds in each 20 millisecond sampling cycle, the average current per segment is (9 milliseconds/20 milliseconds) (15 mA) = 6.75 mA.

### led displays

The LED displays used in this project are equivalent to the famous MAN-1. The pinout configuration and schematic are shown in fig. 4. The forward-bias threshold on each segment is slightly more than 1.6 volts. This property alone makes it virtually impossible to check out junction continuity and performance with multi-meters equipped with an ohms-scale voltage source of 1.5 volts. The best way to check out the LED displays is to use a 4.5- to 5-volt supply with a series current-limiting resistor of 220 ohms. If purchase of MAN-1s from some of the surplus dealers is contemplated, this setup will prove valuable in judging display performance on a segment-by-segment basis. The displays will appear to be a little dimmer in the finished counter because, as

pointed out earlier, the average dc current through the segments is 6.75 mA.

The MAN-1s are common-anode displays. Common-anode displays can only be used with decoder ICs like the SN7446 because of the polarity of the open-collector outputs. Common cathode displays will not work in this project. The MAN-1 display has its segments partitioned into three groups. It is necessary to tie all three common elements together (pins 3, 9 and 14) to get all of the segments to light up on command. Litronix Data Lite 707 and the Opcoa SLA-1 are excellent substitutes.

### input buffer-counter preamp

The input buffer stage is designed to amplify low-level signals to the amplitude necessary to drive TTL logic circuitry. The transistors chosen for this two-stage amplifier are the HEP 709s by Motorola. The gain-bandwidth product of these devices is 600 MHz, which makes them well suited for this application. Their low saturation voltage ( $V_{ce(sat)}$ ) is on the order of 0.3 volt, low enough to ensure a logic 0 at the input of a TTL device.

Resistor R1 acts as a buffer between the transmission line input and the base circuit of Q1 so that the incoming signal is not clipped or loaded down by the base-emitter junction of Q1. The parallel combinations of C1-C2 and C4-C5 provide coupling from several kHz through the vhf region. Ceramic capacitors become somewhat lossy and inductive at high frequencies, so silver-mica capacitors (C2 and C5) are used to provide additional coupling at the high-frequency end of the counter range.

Diode CR1 is a high-speed switch that protects Q1 from negative-going peaks appearing at the base-emitter junction. Resistor R4 matches the collector circuit of Q1 to the base circuit of Q2, and also contributes to overall amplifier stability. C3 is a 10 pF silver-mica capacitor that compensates for the base-to-emitter capacitance of Q2.

To keep stray capacitance to a minimum, short com-

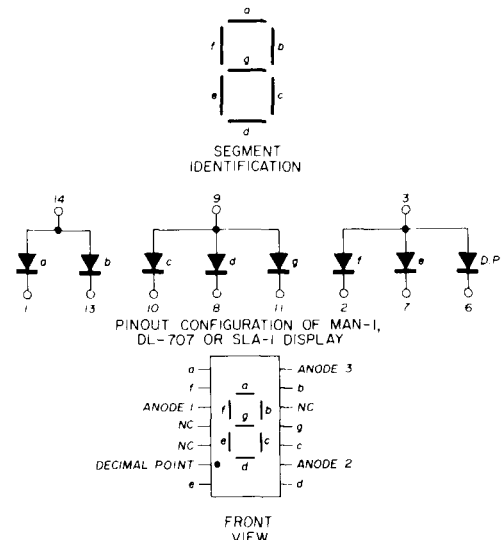

fig. 4. Pinout connections and schematic of the MAN-1 LED display.

ponent lead lengths are of prime importance. The braid of the coax cable should be soldered as close as possible to Q1's emitter to prevent ground-loop problems. Printed-circuit boards with the customary ground planes are not necessary if the layout is as neat and compact as possible. The amplifier should be near U8 since the collector of Q2 drives pins 12 and 13 of U8.

### input amplitude voltmeter

Since digital logic has a threshold with respect to triggering levels, a means of monitoring the input signal level

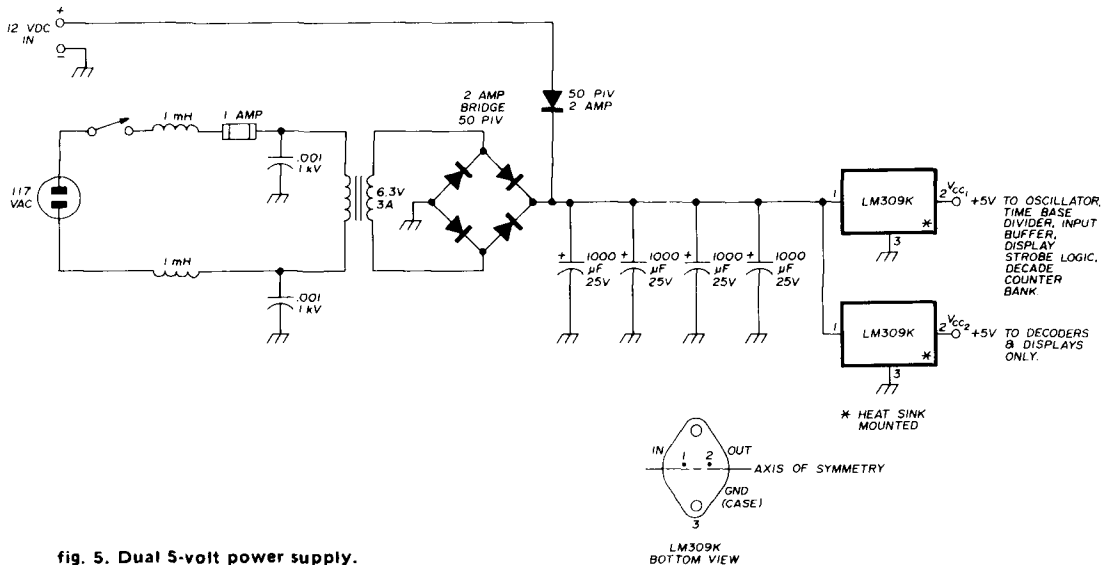

fig. 5. Dual 5-volt power supply.

is necessary to ensure that the counter chain is receiving enough drive to operate reliably. Insufficient drive level can cause triggering errors, in which case the counter counts only a few pulses that happen to break the threshold level.

This circuit consists of an fet voltmeter equipped with an rf probe. The meter is calibrated to read 5 volts peak-to-peak or 1.78 volts rms full scale. The 25k trimpot in series with the 0-50 microammeter is used to calibrate the circuit. The 1k trimpot provides an electrical zero adjust. Calibration can be done with any high-frequency source of known amplitude. The 1-MHz output at pin 11 of U1 has an amplitude of about 3.6 volts peak-to-peak, which can be used if no other calibrated source is available. Before beginning the calibration, the meter should be both mechanically and electrically zero adjusted. The zero adjust on the front panel of the meter should be checked before you apply supply voltage to the fet voltmeter circuit.

### power supply

The power supply, fig. 5, is straightforward thanks to the LM309K voltage regulators. Two 5-volt supplies are derived from the 9-volt dc supply. The  $V_{CC1}$  supply is connected to the  $V_{CC}$  pin of all the ICs except the decoders. The  $V_{CC2}$  supply powers the decoder ICs and the LED displays only.

The purpose of splitting up the power supply in this

fashion is to divide the current demand of the frequency counter so that the regulators operate well below their maximum ratings. The dual power supply also provides excellent decoupling between the decoders, display switching circuitry, and other parts of the counter logic.

### sensitivity measurements

These measurements were made with a Tektronix 191 constant-amplitude rf generator, a Hewlett-Packard audio oscillator, and a Tektronix 7000 series scope. The following results were observed with a sine wave input.

Upper and lower cutoff frequencies of the counter were noted with respect to a given input amplitude. These numbers represent input levels necessary to ensure reliable triggering of the decade counter stages.

amplitude (mV rms)	lower cutoff frequency (kHz)	upper cutoff frequency (MHz)
5 mV	200	10.20
10 mV	150	14.00
15 mV	100	18.15
20 mV	33	23.00
50 mV	20	45.70

The counter works well with signal levels up to 1.5 volts rms (4.5 volts p-p). At greater amplitudes, the base-collector junction of Q1 is forward biased during the positive peaks of the input signal thereby degrading its vhf performance.

### references

1. Bert Kelley, K4EEU, "Divide-By-Ten Frequency Scaler," *ham radio*, August, 1970, page 26. See also "Short Circuits," *ham radio*, April, 1971, page 72.
2. F. Everett Emerson, W6PBC, "Advanced Divide-By-Ten Frequency Scaler," *ham radio*, September, 1972, page 41. See also "Short Circuits," *ham radio*, December, 1972, page 90, and "Comments," *ham radio*, November, 1973, page 64.
3. F. Everett Emerson, W6PBC, "Circuit Improvements for the Advanced Frequency Scaler," *ham radio*, October, 1973, page 31.

ham radio



# Turned on by Audio? TV? Citizens Band? Let NRI turn your interest into income.

Get into a good thing . . . get into TV and Audio Electronics and take advantage of the growing need for full and part-time technicians. And do it at your own convenience, in your own home at your own speed with proven NRI training. "Bite-size" texts speed learning and professional help is always available from your NRI instructor. Over a million men have already chosen the NRI way to a better life.

## Build color TV, Quad Hi-Fi

No one else gives you so much. You learn by doing with NRI's exclusive "Power-On" training. In our Master TV/Audio Course, you actually build a 25" (diagonal) solid state TV, a solid state quadraphonic audio center complete with four speakers, and useful test instruments like a TV pattern

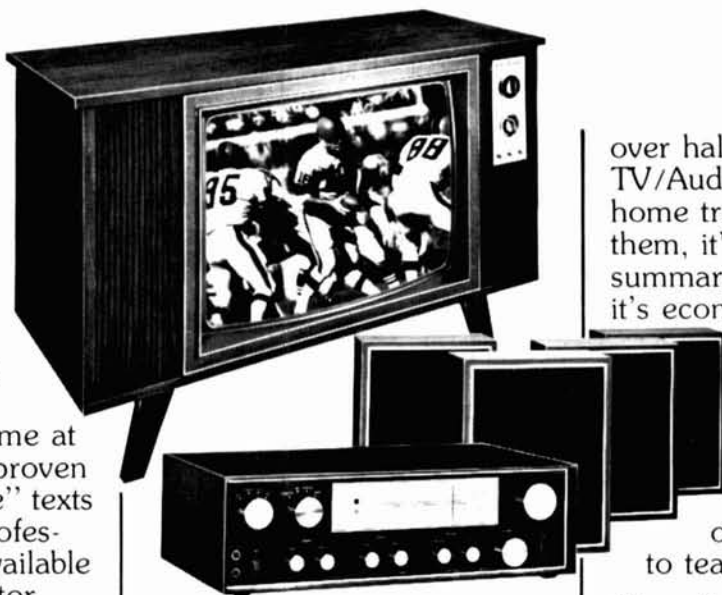

generator, 5" triggered sweep oscilloscope, CMOS digital frequency counter, and transistorized volt ohmmeter. All this, plus our unique Discovery Lab and seven other electronics kits shows why NRI gives you the most in practical bench training.

## The Pro's choice for 62 years

NRI is the oldest and most successful school of its kind. A documented national research study shows that

over half of the professional TV/Audio technicians have home training, and among them, it's NRI 2 to 1 (survey summary on request). And, it's economical. For what you'd pay for either course from the next leading school, NRI gives you *both* TV and quad audio training . . . training on equipment designed to teach!

## Send for free catalog

Our big new catalog tells all about the many NRI courses in TV, Audio electronics, CB radio, computer technology, and more. It shows you lesson plans, equipment, career opportunities, the whole NRI story. There's absolutely no obligation and no salesman will ever call. Send now... it could be the turn-on that turns your life around.



Rush the free catalog of my choice (select only one, please). No salesman will call.

- |  |  |
|--|--|
| <input type="checkbox"/> Communications with CB Complete Communications Electronics • FCC Licenses • Aircraft Electronics • Mobile Communications • Marine Electronics | <input type="checkbox"/> TV/Audio Servicing Choose from 5 courses  |
| <input type="checkbox"/> Amateur Radio Basic and Advanced Courses  | <input type="checkbox"/> Appliance Servicing Homeowner & Professional Repairs  |
| <input type="checkbox"/> Industrial & Business Electronics Digital Computer Electronics • Electronic Technology • Basic Electronics • Math for Electronics             | <input type="checkbox"/> Automotive Mechanics Master Automotive Technician • Tune-Up and Basic Repairs                 |
|  | <input type="checkbox"/> Auto Air Conditioning   |
|  | <input type="checkbox"/> Air Conditioning & Refrigeration  |
|  | <input type="checkbox"/> Basic Air Conditioning Servicing • Master Course in Air Conditioning, Refrigeration & Heating |



**NRI SCHOOLS**  
McGraw-Hill Continuing Education Center  
3939 Wisconsin Avenue,  
Washington, D.C. 20016

9-016

APPROVED FOR CAREER STUDY UNDER GI BILL.  
Check for details.

Name \_\_\_\_\_ Age \_\_\_\_\_  
(Please Print)

Street \_\_\_\_\_

City/State/Zip \_\_\_\_\_

Accredited Member National Home Study Council.

# antenna and tower restrictions

A complete discussion  
of deed restrictions,  
zoning ordinances  
and building codes,  
and how they may affect  
that new antenna system  
you want to install

When planning to buy or build a new home an amateur's first thoughts are inevitably of antennas. How many towers, and how tall shall they be? He may remember stories of amateurs who have been faced with lawsuits because of deed restrictions or zoning regulations, but rarely is this an overriding consideration in the choice of a house or lot. Let the wife pick out the house first -- he can worry about those things later. This should not be. The dangers to ham operation are real, and unfortunately seem to be getting greater.

No one can assume that he has an inalienable right to do whatever he wishes with his property. Like all of our rights, they are subject to many limitations. If you take the attitude that some vaguely-worded deed restriction or zoning ordinance will be decided in your favor by the courts, you *may* be right. However, it could still cost you thousands of dollars in legal fees to establish your rights, and unless you are independently wealthy and enjoy litigation, it could be a Pyrrhic victory.

I recently bought a lot and built a house, and in the course of doing this learned a great deal about the subject. Because of various restrictions, I rejected lots that were otherwise very desirable from the standpoints of location and price. Eventually I found a lot that was satisfactory from all standpoints, but it was not easy. This article will describe the nature of the problems you may be faced with, and what you should do to minimize your risk.

Perhaps the best way to describe deed restrictions is to demonstrate how they work: The owner of a tract of land wants to subdivide it into building lots and sell them. If the owner of the tract is also a builder, he wants to sell you a house with the lot. It is naturally his desire to get as high a price as possible for his lots, and it is therefore in his interest to impress you with the desirability of living in his development. He wants to convince you that the area is definitely high-grade, and will, furthermore, remain that way and not deteriorate. He drafts a "Declaration of Restrictions." This document generally describes the type of house, garage, etc., you may erect on the property, the minimum setback, type of fence, and other items. The developer submits his plat and restrictions to the local zoning commission or other cognizant authority, and if they comply with local planning and zoning laws, they are approved and recorded. The deed to your property will probably say "Subject to any restrictions of record" or something similar. The restrictions are now legal.

Anyone who buys property in this subdivision is, in effect, signing a contract to abide by these restrictions, and if he violates them he can be sued by any property owner or group of property owners in the subdivision.

Of course, there is no certainty that you will be sued if you violate the restrictions. But you are certainly subject to lawsuits. If the development is new, the developer himself may sue, since he may feel that the presence of a 70-foot tower makes it more difficult for him to sell his remaining lots. But even after the subdivision is all sold out, at which time the original developer rapidly loses interest in the character of the neighborhood, any property owner can sue if he finds your tower objectionable, and, depending on the exact wording of the restrictions, would probably have a good chance of winning. The result would be a court order for you to remove your tower.

In my search for a lot, I accumulated quite a collection of sets of restrictions. Every one of them, to a greater or lesser degree, implied restrictions on the erection of antennas although the wording varied. In fact, most of them made no mention of antennas as such. These specified in detail what you *could* put on the property -- and an amateur antenna was *not* one of the permitted things. Typical wording was, "No structure other

Harry R. Hyder, W7IV, 9842 North 57th Street,  
Phoenix, Arizona 85253

than a single-family dwelling . . . garage, swimming pool, etc . . . shall be erected or permitted to remain on this property.

One local amateur was sued by a developer for violation of a restriction like that. He won his case because his tower was mounted on top of his carport, and the court ruled it was part of the house and not a separate structure. Presumably if the tower has been mounted on the ground apart from his house, he might have lost. This victory cost the ham \$2500 in legal fees. Some victory.

Other restrictions specify a maximum height above ground or roof level that no structure can exceed; 35 feet (11 meters) above ground level or 3 feet (1 meter) above roof level are common values.

Some restrictions do mention antennas. One actually specifically permitted amateur radio antennas but said that the towers must be of the retractable type and lowered when not in use. One planned community in the Phoenix area bans all outdoor antennas including TV antennas (this community has a master antenna and cable distribution system).

Another common type of restriction states that anything erected on the property must be approved by the "Architectural Committee" of the development.

When considering lots, I always asked the agent whether there were any restrictions on the erection of amateur antennas, and was usually assured that there were none. This frequently turned out to be not quite true. Very rarely, in fact, did the agent have a knowledge of what the restrictions actually said. Ask the agent to get a copy of the restrictions, which he can easily do, and read them yourself. You can get copies yourself as most of the large title insurance companies have this information on file. Alternately, you can get copies at the County Recorder's office (to be valid, the restrictions must be a matter of record).

All of this sounds pretty discouraging, but there are subdivisions that do not have any restrictions. This is

The restrictive covenants, zoning ordinances and building codes which affect amateur radio antennas vary widely from one locale to another, and much of the law is case law which varies greatly from state to state. Some states, for example, have given substantial weight to aesthetics while other states have held that aesthetics cannot be considered at all. And, although the law on restrictive covenants is much more uniform from state to state, there are conflicting opinions in amateur radio cases. Furthermore, the application of common and statutory laws on nuisances is a rather new development which is certain to become more of a problem in the years ahead.

This article is based on the author's experiences in the Phoenix, Arizona, area, so the restrictive covenants, zoning ordinances and building codes may be considerably different than in your own area. Nevertheless, his basic guidelines are applicable in practically every case. Following these guidelines may not keep you completely out of trouble (witness the nuisance cases of W0MYN and W2OVC), but they should give you a foot up on the problem.

Editor

more likely to be true of older areas since it has been only relatively recently that restrictions of this sort have become widespread. There are also many odd pieces of property that have never been part of subdivisions. If you look hard enough, you can find a suitable house or lot that has no restrictions.

In any event, you should have your attorney insert a clause in the sales contract that your money will be returned if any restrictions on the erection of ham antennas are found to exist.

### **zoning ordinances**

Unlike deed restrictions, which are in the nature of private contracts, zoning regulations are a matter of law. Zoning is an attempt by a municipality or county to control the usage of land within its boundaries for the purpose of orderly growth and development. Sections of the incorporated area are designated residential, commercial, industrial, etc., and within these classifications are sub-classifications.

The various types of residential zoning control the number of residences per acre, whether single-family or apartment buildings, maximum height, setback from the street and property line, street and utility easements, and similar matters. Depending on the exact wording, zoning regulations can imply prohibition of the erection of antenna towers, or can expressly forbid them. Some even expressly permit them. The zoning regulations of Scottsdale, Arizona, for example, specifically permit antenna towers up to 70 feet (21 meters).

In contrast, Paradise Valley, a bedroom community adjoining Phoenix, forbids *all* towers. An amusing sidelight to this is that Paradise Valley's most distinguished citizen is Senator Barry Goldwater, K7UGA. Senator Goldwater's home is equipped with two tall towers mounting quite an array of beams, including a very impressive log-periodic.

The Phoenix Zoning Ordinance controls building height, but a paragraph specifically excludes antennas, flagpoles, water towers, etc., from the height restrictions.

In general, amateurs are in less danger from zoning ordinances than from deed restrictions. One reason is the natural slowness of democratic governments to react except in the face of political pressure. Another is the fact that most municipal or county attorney's offices are very understaffed, and are not anxious to undertake such suits, which do not have the glamour of, say, criminal prosecutions. Nevertheless, city and county attorneys are usually elected officials, and if one of your neighbors objects to your antenna, and he is politically well-connected, you could be in for trouble.

The amateur does have one thing going for him. There seems to be an unofficial legal principle that says what others have done in the past without legal interference, you can do too. If there are a number of amateurs in your city who have towers and have never been threatened with legal action, regardless of the exact wording of the zoning regulations, you are probably on safe ground.

In any event, it is a good idea to become familiar with your local zoning regulations. These can be obtained from your local planning and zoning commission, usually located at city hall or nearby. The complete Phoenix Zoning Ordinance, a sizable book, costs \$5.00, and by paying an additional \$5.00, you can be placed permanently on the mailing list for changes and additions. Other cities probably have similar arrangements.

### building codes

Building codes are designed to protect the health and safety of the citizens of a political division. Antenna towers come into this because an improperly designed or installed tower could collapse and cause damage to life or property. I have personally seen antennas that seemed to stay up by sheer faith, and it seems reasonable that anyone erecting a tower should be able to demonstrate that it will not be a hazard to himself or his neighbors.

Relatively few amateurs apply for building permits for towers. I strongly recommend it. In principle, at least, if you do not get a permit with its attendant inspections, you could be forced to take your tower down. It's difficult to say just how likely this is to happen as it is highly dependent on your local administration, but it can and has happened. In any event a building permit is a nice piece of insurance against that possibility.

In some localities obtaining a building permit is mere formality. Some areas even have special provisions in their local codes for amateur radio towers. In others it is more difficult. A typical requirement would be a set of plans and stress calculations approved by a registered professional engineer. First find out from your local building inspection department what is required, and then attempt to supply it.

One problem that you may run into is that the personnel in your local inspection department have never been asked to issue a permit for a tower before, and like true bureaucrats, assume that since they have never done it before, it must be illegal. Don't stop there.

An experience of mine is enlightening. When I was interested in buying a piece of property in a local community, I went to the inspection office and asked the man behind the counter how to apply for a permit for a 50-foot (15-meter) antenna tower. He informed me very positively that such a tower was not permitted and he could not issue me a permit. I then asked him why the local zoning ordinances permitted antenna towers up to 70 feet (21 meters) if they were illegal (I had already checked this). I then showed him the wording of the ordinance, and he confessed that he had never seen that paragraph. He allowed as how he probably could issue a permit, but would have to check with the city engineer about the actual requirements. I did not pursue the matter at that time, and I eventually bought my lot elsewhere, but an amateur friend of mine subsequently received a permit for a 60-foot (18-meter) tower from the same office merely by supplying a set of the tower manufacturer's plans and specifications.

Don't stop at the first "No." Building inspection departments are bound by law and cannot act arbitrarily. If the zoning laws do not prohibit towers and if you can demonstrate that the tower design and installation are sound, they are bound to issue you a permit. The cost is usually about five dollars.

It would be a good idea to read the sections of your local building code dealing with towers. You can do this at the inspection office. If you run into any problems it would be a good idea to request a personal talk with the city or county engineer. They are usually pretty reasonable.

In the city of Phoenix the law requires that the tower stress calculations be checked by a registered professional engineer in the *State of Arizona* and that he supply a letter saying that he has done this, duly stamped with his seal. I don't know how widespread this requirement is, but it could mean a fee of \$50 or more. In my own case, the tower I was planning to erect had already been approved for a previous applicant. Some areas have approvals for specific makes and models of towers on record; this constitutes a sort of type acceptance. It would be a good idea to find out which types have previously been approved, and if one of these suits your requirements, getting a permit should present no problems.

Another thing to do is to find a local amateur who has successfully obtained a building permit and find out what procedure he followed. When dealing with the law, precedent is highly important.

### conclusions

While it may be troublesome and frustrating to run the gauntlet of deed restrictions, zoning ordinances and building permits, it can be done — the most important ingredient is persistence and it is worth it. Amateurs have been ordered by the courts to remove their antennas for violation of all of these, and it gives you a comfortable feeling to know that you are completely protected.

ham radio



DEMCHICK

"They're recalling your outside antenna."



# KENWOOD

... pacesetter in amateur radio



**The TS-520 with its companion VFO-520 and SP-520**

The TS-520 is the final word in SSB transceivers... the "hottest little rig on the air." Built-in AC/DC power supply, compact and extremely reliable. The TS-520 is loaded with features... loaded with Kenwood quality.



**The TV-502**

... puts your TS-520 on the 2 meter band. Solid-state, 144 to 146 MHz. SSB and CW... priced right.



**The R-599D and T-599D**

... the most complete and versatile solid-state receiver and transmitter combination on the ham bands. Thousands of "Twins" have proven themselves in world-wide, daily use. And now we've given them a rich, new darker appearance. Shown with the matching S-599D.



**The TS-700A**

2 meter transceiver... the best! Operates on SSB (upper & lower), FM, AM, and CW. Built-in AC/DC capability. 4 MHz band coverage. 44 channels with 11 crystals.



**The QR-666**

... world listening at its best. New solid-state communications receiver. AM, SSB and CW. The last word in state-of-the-art technology.

Available at select Kenwood dealers throughout the U.S.



**TRIO-KENWOOD COMMUNICATIONS INC.**

116 East Alondra / Gardena, California 90248

# diode detectors

## A comparison of the operating characteristics of various diode detectors and how they can be improved through modern circuitry

From the earliest days of radio the subject that received the most attention of radio amateurs (first unlicensed, and later with amateur calls) was the detector. The antenna-ground system, although it allowed for a good deal of innovation, was generally size-limited by the amateur's real estate or by the basic laws of physics. Also, antennas are fun to work on only in decent weather; little antenna work is done during the winter months. The transmitter was also straightforward: you simply bought as large a transformer as you could afford. The spark gap and its coupling to the antenna-ground system were relatively simple.

The detector, however, didn't cost much and could be worked on at any time so thousands of experimenters tinkered away their winter evenings trying to improve their detectors. Eventually they had enough success that the detectors became known as "receivers." Another nice feature of experimenting with detectors was that you could receive signals to "get a foot in the door" of radio, even if you had no transmitter. All sorts of devices were tried by these early experimenters: flame ionization detectors, coherers, electrolytic detectors, thermo-electric detectors, magnetic hysteresis detectors, crystal detectors and the early Fleming valve (vacuum diode).

Of all the early detectors the crystal type received the most widespread usage and "crystal set" eventually be-

came a household word. Various types of mineral and man-made crystals such as galena, silicon, perikon (copper pyrites and zincite), molybdenite and carborundum were used. Fig. 1 shows a simple crystal set using one of the crystals of the period. This same circuit could still be used today, but a modern signal diode would be used in place of the crystal and catwhisker.

Galena (lead sulphide), an important lead ore found here and in Europe, was the most popular of the crystals used in the early days of radio because it was the most sensitive. Steel galena, so called because it resembles a piece of broken steel rod, contains a small percentage of silver and, although not quite as sensitive as plain galena, became popular in later years because it was somewhat easier to adjust.

The crystals used as radio detectors were mounted in clips, held in tin-foil cups, floated in mercury, or more commonly, mounted in a small "pill" of a low-melting-point alloy. (Some experimenters who tried to mold their own crystal holders used a too-hot mixture of lead, only to discover that the heat destroyed the sensitivity of the galena.) The catwhisker, a length of fine, stiff wire,\* was moved about the surface of the crystal until an "active" spot was found. This metal-to-semicon-

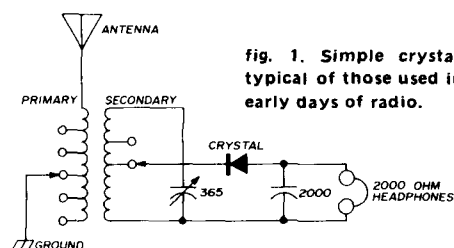

fig. 1. Simple crystal set typical of those used in the early days of radio.

\*Different types of crystals require different catwhiskers. Galena, for example requires a stiff, clean catwhisker with very little pressure. Plated copper is best, with brass and platinum running a close second. If you use a steel galena crystal, however, a German-silver catwhisker is best. For silicon crystals, tungsten catwhiskers are preferred although molybdenum is sometimes used. Chromium or steel are recommended as catwhiskers for carborundum crystals (which also require a bias battery), while many different metals have been used successfully with molybdenite crystals.

Hank Olson, W6GXN, Post Office Box 339, Menlo Park, California 94025

ductor interface is similar in many ways to the point-contact diodes of today. A typical galena-catwhisker assembly is shown in fig. 2.

The success of the vacuum tube, first as a diode (Fleming valve) and later as a triode (DeForest Audion) eclipsed the crystal detector commercially after about 1921. Crystal sets continued to be used by experimenters, however, as they still are today. Also, work continued in the laboratory on silicon crystal detectors as power detectors for microwave measurements.<sup>1</sup> This laboratory experimentation was greatly refined and expanded during World War II as engineers tried to solve the microwave radar mixer problem. This concentrated research effort on crystal detectors eventually led to a huge body of knowledge on basic silicon and germanium crystal physics and how various impurities affect the semiconducting properties of these materials.



Steel galena crystal offered to amateurs in the 1920s.

The high-inverse voltage germanium point-contact diode came directly out of these wartime research efforts, and most of the other semiconductor developments we know today came indirectly from this same research. The twenty-eight volume MIT Radiation Laboratory Series includes one whole volume which describes the semiconductor diode developments for radar usage which occurred during this period.<sup>2</sup>

Based upon the research done during the war, germanium point-contact diodes became available to industry in the late 1940s. The 1N34 was offered by Sylvania,

\*Mounted galena crystals, crystal stands and catwhisker assemblies are available from Modern Radio Laboratories, Post Box 1477, Garden Grove, California 92642. Their catalog, available for 25¢, also lists an assortment of crystal-set kits and other hard-to-find items such as carborundum detectors and coil sliders.

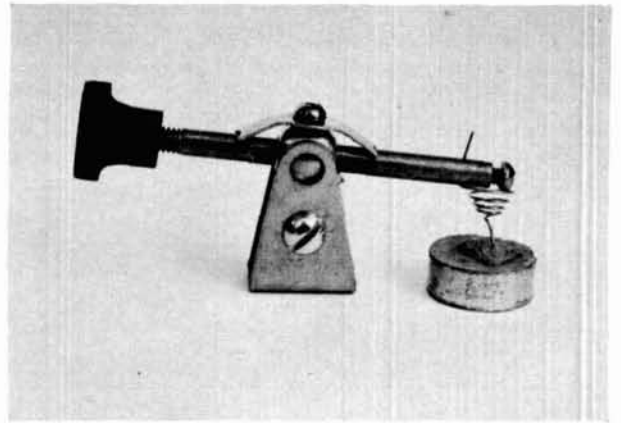
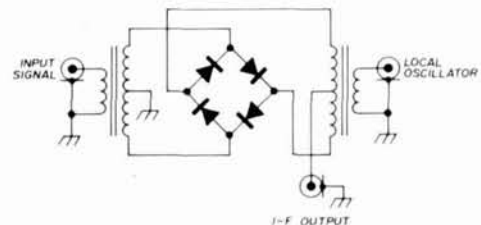

fig. 2. Commercial galena-catwhisker assembly. These units can still be obtained at some radio distributors.\*

immediately became popular with experimenters, and started showing up in everything from absorption wave-meters to a-m speech clippers.<sup>3</sup>

The alloyed-junction silicon and germanium diodes came along in the early 1950s.<sup>4,5</sup> The germanium junction diode achieved some degree of popularity as a rectifier (1N91 - 1N93) but is considered obsolete today while the silicon junction diode came into its own *both* as a signal diode and power rectifier. An example of an early alloy-junction rectifier is the 1N536-1N540 family; the 1N482-1N485 family are typical early alloy-junction signal diodes.



(A) DOUBLE-BALANCED MIXER

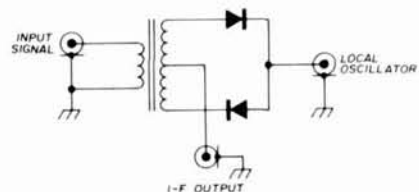

(B) SINGLE-BALANCED MIXER

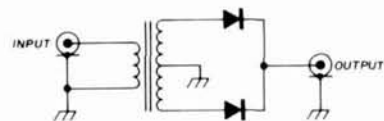

(C) BROADBAND DOUBLER

fig. 3. Three diode circuits which use Schottky diodes. Shown in (A) is a typical double-balanced mixer. A single-balanced mixer is shown in (B) while (C) shows a broadband doubler circuit.

While most modern silicon junction rectifiers are still made by the alloy process (1N4001-1N4007, for example), newer silicon junction signal diodes are usually made by the planar epitaxial process (1N4454, for example). If you insist on a germanium junction signal diode, the base-emitter elements of a germanium junction transistor (2N404 or 2N5043) could be used.

There have been many other types of diodes developed since the silicon and germanium types discussed above. Tunnel, PIN, step-recovery, varactor, zener,

Virtually all Schottky diodes are silicon types, and their advantage over point-contact types is that their characteristics are closely matched and *stable*. This stability quality is quite important because it allows the close *matching* of diode pairs or quads which make it possible to build really good double-balanced mixers. The double-balanced mixer and its related single-balanced mixer and broadband doubler have made an enormous impact on modern vhf, uhf, and microwave systems.

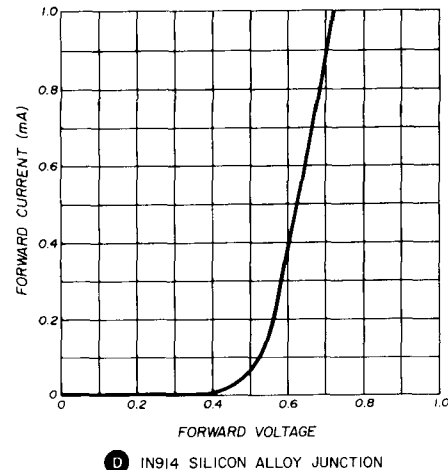
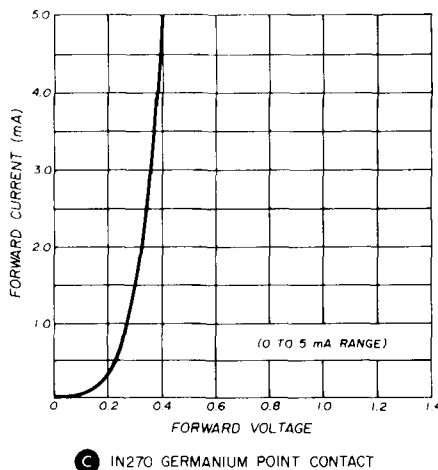
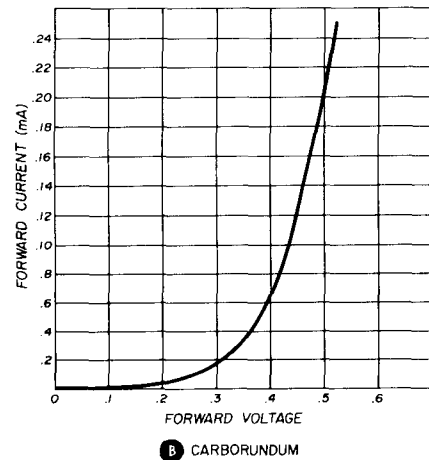
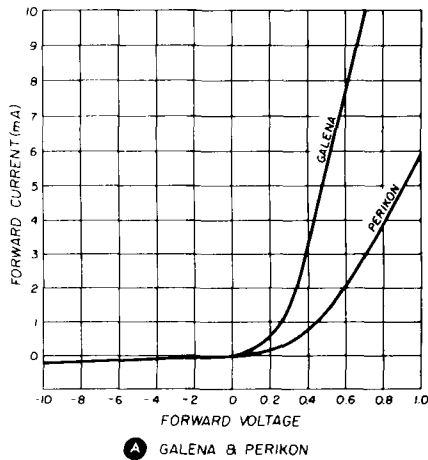

fig. 4. Forward conduction characteristics of several different diode types including galena and perikon (A), carborundum (B), germanium point contact (C) and silicon alloy junction (D).

Gunn, IMPATT and TRAPATT are some of these special types, but are not, in general, used as detectors of the common, rectifying type.

One newer type of diode, the Schottky-barrier or hot-carrier diode, has characteristics similar to the point-contact device. Like the point-contact diode, the Schottky diode uses a metal-semiconductor junction; in the Schottky diode, however, the metal is deposited on the semiconductor by sputtering in a vacuum. Examples of the Schottky diode are the Hewlett Packard 5082-2800 and the Motorola MBD501.

Three basic diode circuits which use matched Schottky diodes are shown in fig. 3. Note that the transformers in fig. 3 are usually built with a few turns of wire on ferrite toroids, so the circuits are often useful over a three-decade frequency range (200 kHz to 200 MHz is common).

The forward conduction characteristics presented in fig. 4 will give you an idea how some of the various semiconductor diodes compare. The curves in fig. 4A for galena and perikon are from reference 6, the carborundum curve (fig. 4B) is from reference 7, while the for-



ward characteristics for the 1N270 (fig. 4C) and 1N914 (fig. 4D) were taken from the data sheets of currently manufactured diodes. As can be seen, the forward current characteristic of any diode semiconductor diode is far from linear.

### diode detectors

An early article by Colebrook exhaustively describes crystal rectifiers and their use as detectors of radio

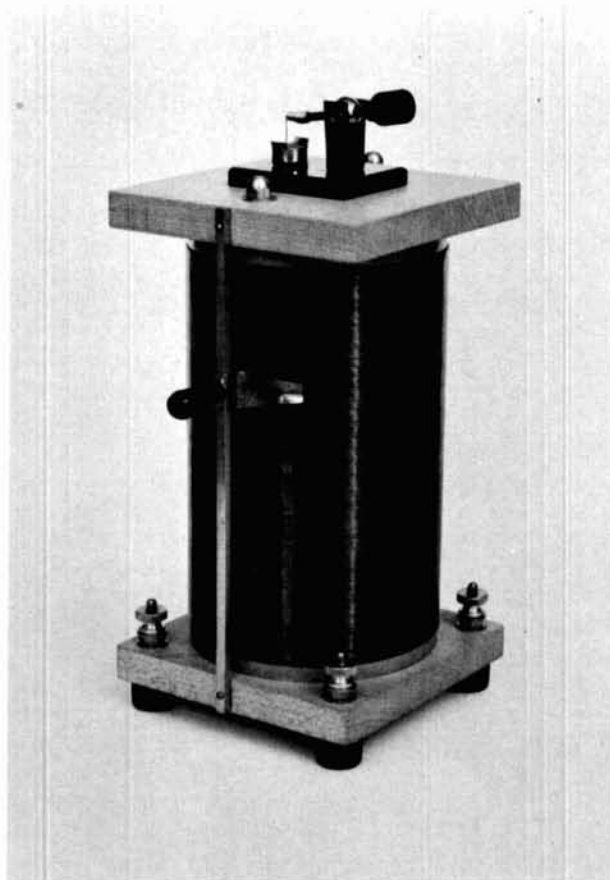

Crystal receiver of the type used by amateurs sixty years ago. Station was tuned in by moving the slider along the tuning coil. Selectivity was very poor, but there were few stations on the air and a local spark transmitter wiped out the DX anyway.

signals.<sup>6</sup> Although the author had only early galena and perikon diodes to work with, his mathematical analysis and conclusions are as fresh today as they were when written in 1925. The basic diode detector shown in fig. 5 is the same as that used in reference 6.

Fig. 5A shows a resistive load while fig. 5B shows the more usual case where there is a capacitor in parallel with the load resistor (this increased detector efficiency). The capacitor should present a low impedance at the carrier frequency (as compared to resistor R), and a high impedance at the modulation frequencies. In the circuit of fig. 1 a 0.002  $\mu\text{F}$  capacitor is placed in parallel with a set of 2000-ohm headphones. At 1 MHz (the center of the broadcast band, for which this crystal set

fig. 5. Basic diode detectors showing simple resistive load (A) and more usual case where a capacitor is placed in parallel with the load resistor (B).

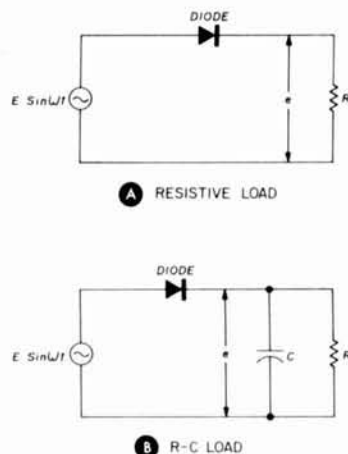

was designed) a 0.002  $\mu\text{F}$  capacitor has about 80 ohms reactance. At 1000 Hz, a typical audio test frequency, the reactance of this same capacitor is nearly 80 kilohms.

The circuit shown in fig. 6 was built to demonstrate how a shunt capacitor increases efficiency, and also to show how several common diode types compare. The 51-ohm resistor at the input simply terminates the amplitude-modulated signal generator. The LM318H IC and associated capacitors and resistors comprise a low-pass filter with a cutoff frequency at 2000 Hz. In this circuit the 2200-ohm resistor, R1, is the detector load and the 510-ohm resistor at the output of U1 is to prevent oscillation of the op amp when using a length of coax to the vtvm. The 0.002  $\mu\text{F}$  capacitor can be switched in or out; the results are shown in fig. 7. For higher input signal levels the capacitor increases the output audio voltage level by 8 to 10 dB (enhancement with the 6AL5 vacuum tube diode is even more marked at some input levels).

Note that since the plots of input rf level vs audio output level presented in fig. 7 are on log-log coordinates (since the abscissa and ordinate are both in dB) two straight lines may be drawn on the plots, one representing a linear relation and the other a square-law relation. For large input signals, say above -20 dBm, all the detectors approach a linear slope. It should also be noted that

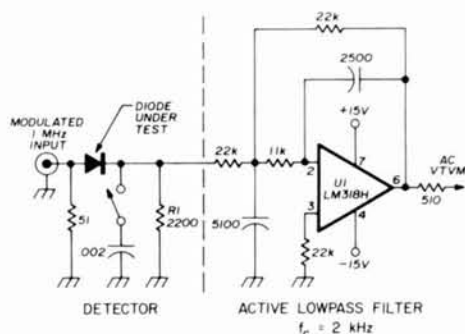
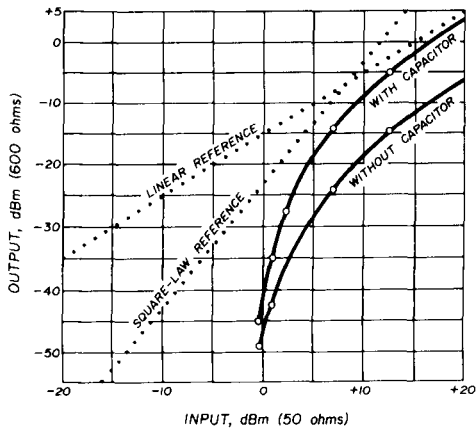
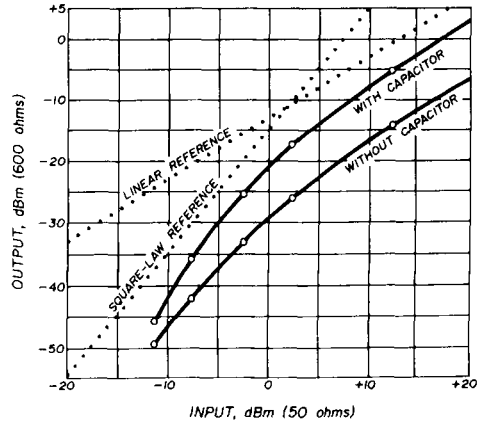

fig. 6. Circuit for testing the operation of various diode detectors. Test results are plotted in fig. 7.



**A** IN4454 SILICON JUNCTION DIODE



**B** IN270 GERMANIUM DIODE

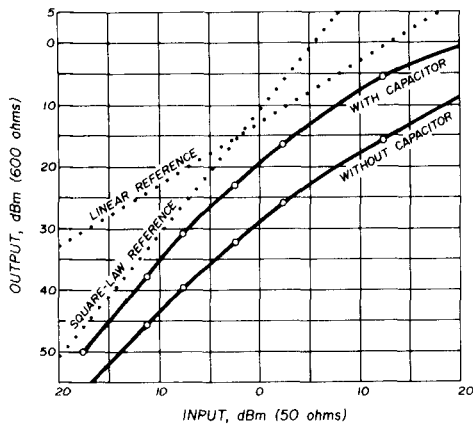

**C** IN82 SILICON DIODE

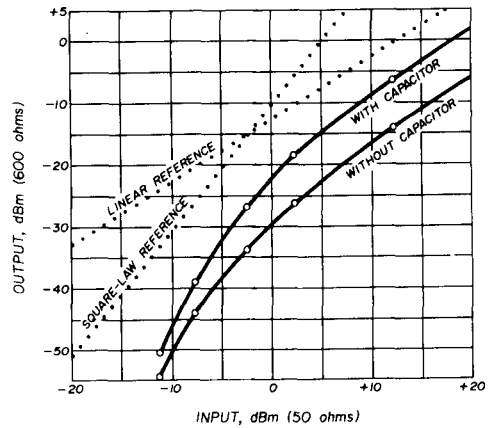

**D** IN34 GERMANIUM POINT-CONTACT DIODE

fig. 7. Rf input level vs audio output level for various types of diodes, with and without parallel load capacitor. Linear and square-law references are shown for comparison.

at input levels below  $-20$  dBm a square-law or larger exponent relationship is usual. The point is that although some diodes are more nearly linear over a larger range of input voltage than others, none of them could remotely be considered as linear detectors at input signal levels below  $-20$  dBm. A 6AL5 detector circuit with capacitor, comes closest, perhaps, to the textbook explanation that "diodes are square-law devices for small signals and linear devices for larger signals."

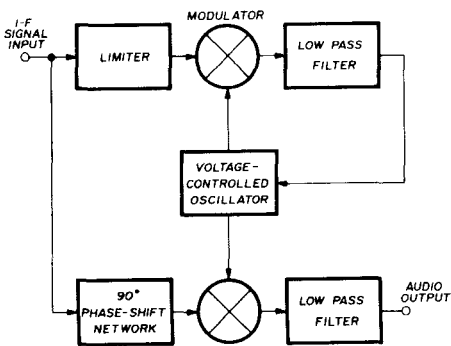

fig. 8. Using a phase-locked loop as an a-m detector (see text).

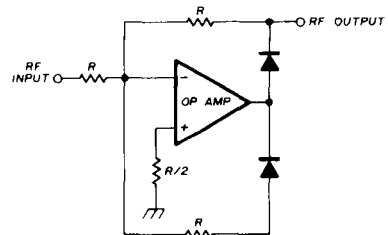
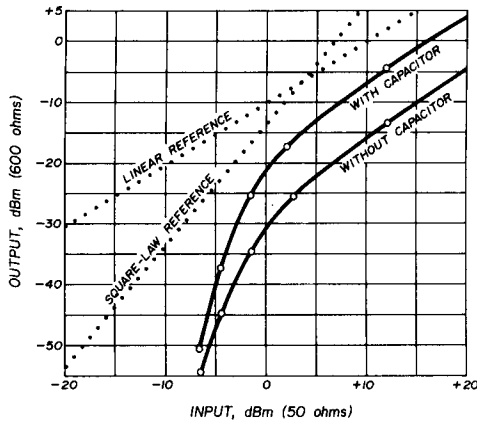
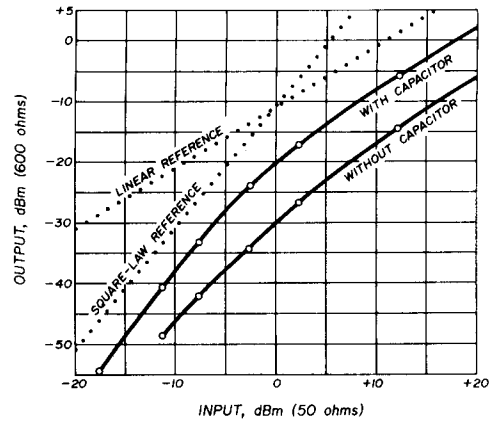

fig. 9. Precision half-wave detector using semiconductor diodes and an operational amplifier.

In a receiver, operation of the diode detector in its square-law region means that for every 10 dB weaker a signal may be, the output is 20 dB down. This is clearly not a good way to operate. Not only does it waste stage gain, it also degrades the signal-to-noise ratio. To avoid the square-law region most receivers use enough rf and i-f gain to keep the input voltage level to the diode detector up in the region where it behaves linearly. Unless agc is used this usually means that the last i-f amplifier must be a small transmitting tube or other large-signal device if reasonable dynamic range is to be achieved.



E H-P 5082-2800 SCHOTTKY DIODE



F GALENA-CATSWHISKER

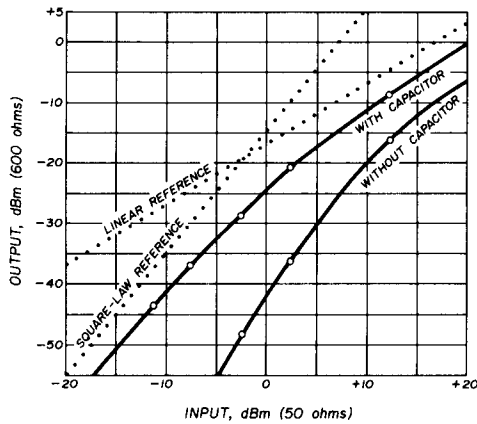

G 6AL5 VACUUM DIODE

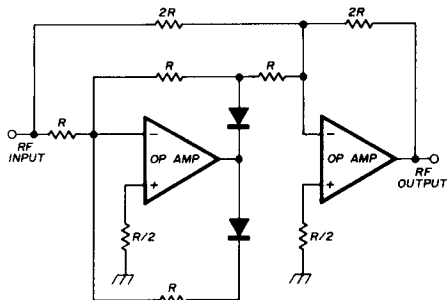

fig. 10. Precision full-wave detector using semiconductor diodes and two operational amplifiers.

### linear diode detectors

Few commercial receivers bother with such luxuries as large-signal capability in the last i-f stage — they either rely on agc or *accept* detector non-linearity. Fortunately, the modern extensive use of ssb on the high-frequency bands has forced receiver manufacturers to use the inherently more linear product detector. The linearity of product detectors, which are essentially mixers with an audio output, is due to the fact that the oscillators which drive them completely control the conduction of the nonlinear devices used as mixers.

The product detector does not make a very satisfactory detector for a-m because the bfo never quite matches the receiver carrier frequency. This results in a beat note being present in the audio output unless a phase-locked loop is used to synchronize the bfo to the

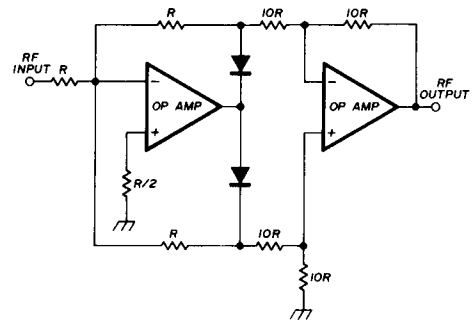

fig. 11. Improved version of the full-wave detector provides better linearity than previous circuits.

received carrier frequency. This phase-locked loop form of a-m detection is shown in fig. 8; with the modern phase-locked loop ICs that are now available the circuit is not unreasonably complex.

Another technique for linearizing an a-m detector involves the use of an operational amplifier. Although this

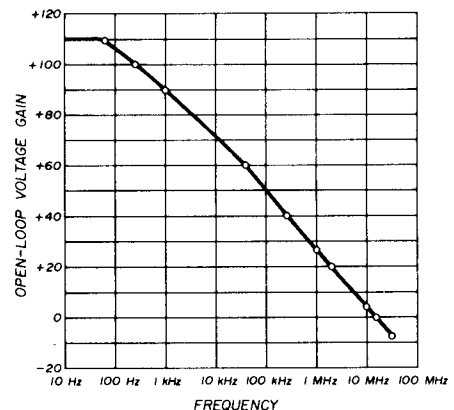

fig. 12. Open-loop gain vs frequency of the LM318H operational amplifier IC.

technique has been around for quite some time, it has only recently become practical with the availability of low cost, high-frequency IC op amps.<sup>8,9</sup> Fig. 9 shows the basic precision diode detector using an op amp. Fig. 10 shows a full-wave version of the detector (from reference 9). The full-wave version has the disadvantage that the delay for positive input signals, which are inverted and amplified two times, is twice that for composite signals. Because of the delay difference, the signals don't subtract in phase, so high-frequency performance suffers. Fig. 11 shows a precision full-wave diode detector, attributed to Dr. Nick Cianos of SRI, that solves the problem.

only expect about 24 dB improvement in linearity at 1 MHz. To check this I built the circuit shown in fig. 13. The test results are plotted in fig. 14. The improvement at low input signal level linearity is quite apparent. The principle of op amp/diode detection is used in the National LM372, an IC that combines the functions of i-f amplifier and a-m detector.

### summary

The diode detector has been the standard a-m detector almost since radio began. Today we essentially have only two choices of semiconductor material: germanium and silicon. Germanium has lower offset voltage while

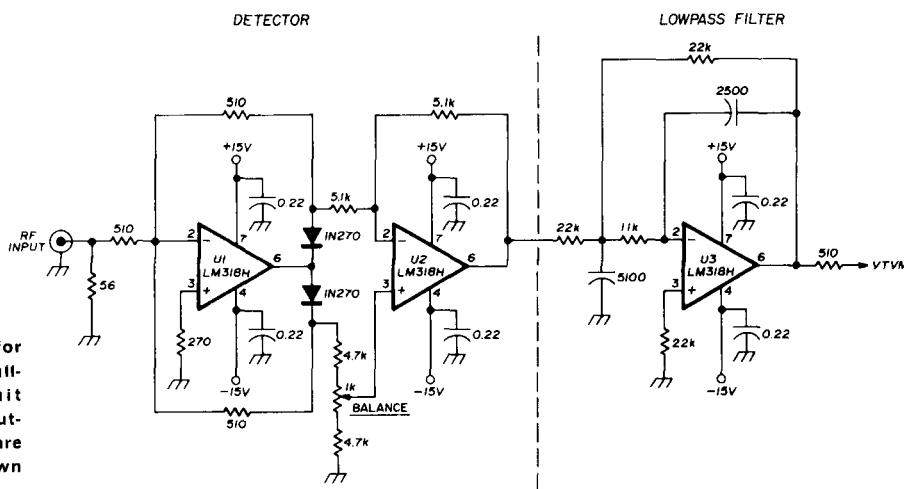

fig. 13. Test setup for checking the improved full-wave detector circuit shown in fig. 11. Input-output characteristics are extremely linear as shown in fig. 14.

Diode detectors which use an op amp in the circuit reduce the input voltage at which the transfer curve (input to output relation) becomes non-linear by a factor equal to the open-loop gain of the op amp. Since op amp voltage gains can be more than 100 dB at the lower frequencies this can make a significant difference in detector performance.

The performance curve of a good monolithic IC op amp (National LM318H) is shown in fig. 12. Note that the open-loop gain drops as frequency increases so you can

silicon has the benefit of improved technological processing. A semiconductor diode of either type, used in combination with a modern IC op amp, can greatly improve the linear dynamic range of the detector. When used as an integral part of an IC the silicon diode holds great promise in the future.

### references

1. G. Southworth and A. King, "Metal Horns as Directive Receivers of Ultra-Short Waves," *Proceedings of the IRE*, number 27, 1939, page 95.
2. H. Torrey and C. Whitmer, "Crystal Rectifiers," Volume 15, *Massachusetts Institute of Technology Radiation Laboratory Series*, McGraw-Hill, New York, 1948.
3. "Electronic Shortcuts for Hobbyists, 24 Simplified Crystal Diode Applications," Second Edition, Sylvania Electric, 1951.
4. W. Pietenpol, "PN Junction Rectifier and Photo Cell," *Physics Review*, April, 1951, page 120.
5. G. Pearson and B. Sawyer, "Silicon P-N Junction Alloy Diodes," *Proceedings of the IRE*, November, 1952, page 1348.
6. F. Colebrook, "The Rectifying Detector," *The Wireless Engineer*, March, 1925, page 330; April, 1925, page 396; May, 1925, page 459.
7. A. Ghirardi, *Radio Physics Course*, Radio & Technical Publishing Co., New York, 1931, page 380.
8. *Handbook of Operational Amplifier Applications*, First Edition, Burr-Brown Research Corporation, Tucson, Arizona, 1963, page 70.
9. G. Giles, *Fairchild Semiconductor Linear Integrated Circuits Applications Handbook*, Fairchild Semiconductor, 1967, page 148.
10. "Linear Applications," Applications Note AN 15-5, National Semiconductor, February, 1973.

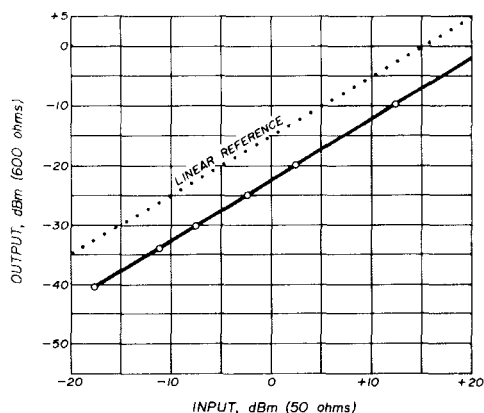

fig. 14. Input-output characteristics of the improved full-wave detector circuit shown in fig. 13 coincides very closely to linear reference.

ham radio

# for the experimenter!

INTERNATIONAL CRYSTALS & KITS

OSCILLATORS • RF MIXER • RF AMPLIFIER • POWER AMPLIFIER



### OX OSCILLATOR

Crystal controlled transistor type. 3 to 20 MHz, OX-Lo, Cat. No. 035100. 20 to 60 MHz, OX-Hi, Cat. No. 035101  
Specify when ordering.

Price \$3.95 ea.



### OF-1 OSCILLATOR

Crystal controlled transistor type. 3 to 20 MHz, OF-1, Lo, Cat. No. 035108. 20 to 60 MHz, OF-1, Hi, Cat. No. 035109  
Specify when ordering.

Price \$3.25 ea.

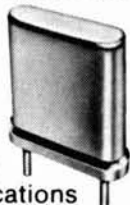

### EX CRYSTALS (HC 6/U HOLDER)

Cat. No.	Specifications
031080	3 to 20 MHz — For use in OX OSC Lo Specify when ordering \$4.95 ea.
031081	20 to 60 MHz — For use in OX OSC Hi Specify when ordering \$4.95 ea.
031300	3 to 20 MHz — For use in OF-1L OSC Specify when ordering \$4.25 ea.
031310	20 to 60 MHz — For use in OF-1H OSC Specify when ordering. \$4.25 ea.



### MXX-1 TRANSISTOR RF MIXER

A single tuned circuit intended for signal conversion in the 30 to 170 MHz range. Harmonics of the OX or OF-1 oscillator are used for injection in the 60 to 179 MHz range. 3 to 20 MHz, Lo Kit, Cat. No. 035105. 20 to 170 MHz, Hi Kit, Cat. No. 035106  
Specify when ordering.

Price. \$4.50 ea.

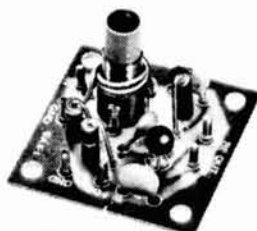

### SAX-1 TRANSISTOR RF AMP

A small signal amplifier to drive the MXX-1 Mixer. Signal tuned input and link output. 3 to 20 MHz, Lo Kit, Cat. No. 035102. 20 to 170 MHz, Hi Kit, Cat. No. 035103  
Specify when ordering.

Price \$4.50 ea.



### PAX-1 TRANSISTOR RF POWER AMP

A single tuned output amplifier designed to follow the OX or OF-1 oscillator. Outputs up to 200 mw, depending on frequency and voltage. Amplifier can be amplitude modulated. 3 to 30 MHz, Cat. No. 035104  
Specify when ordering.

Price \$4.75 ea.

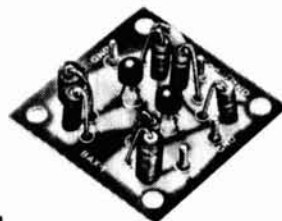

### BAX-1 BROADBAND AMP

General purpose amplifier which may be used as a tuned or untuned unit in RF and audio applications. 20 Hz to 150 MHz with 6 to 30 db gain. Cat. No. 035107  
Specify when ordering.

Price \$4.75 ea.

Shipping and postage (inside U.S., Canada and Mexico only) will be prepaid by International. Prices quoted for U.S., Canada and Mexico orders only. Orders for shipment to other countries will be quoted on request. Address orders to:  
M/S Dept., P.O. Box 32497, Oklahoma City, Oklahoma 73132.



International Crystal Mfg. Co., Inc.

10 North Lee

Oklahoma City, Oklahoma 73102

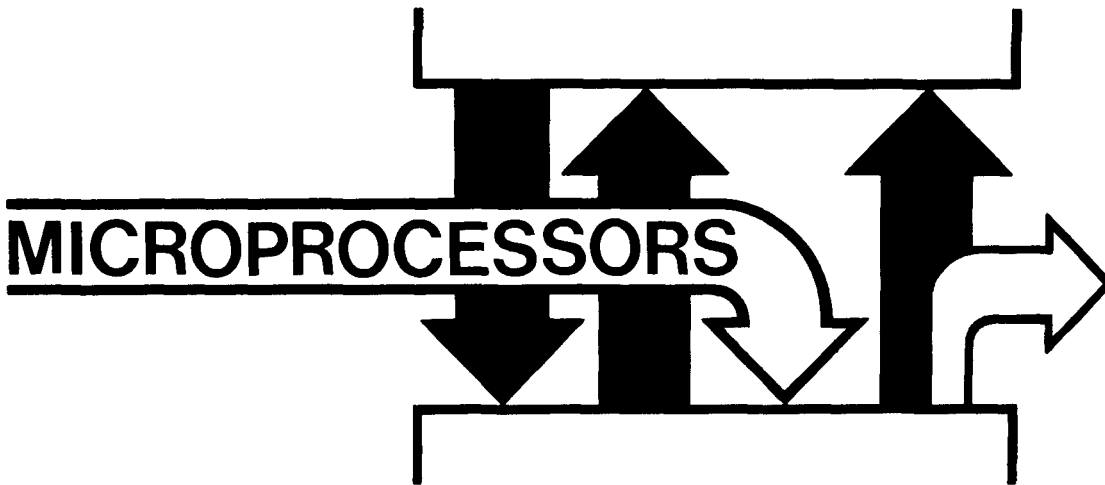

A discussion of  
microprocessors  
and how they fit  
into the scheme  
of computers  
and controllers  
that exist today

By now, most amateurs are aware of the fact that a revolution is occurring in the electronics industry: *microprocessors*. If you had held stock in companies that manufacture microprocessors, this fact would have become quite apparent after RCA's misinterpreted announcement several months ago that microprocessors will soon be incorporated into U.S. automobiles. Rather than rehash an electronics revolution after it is over, we

believe that it would be fun to jump into the middle of the one that is occurring at this moment and closely observe events that will have a profound influence on electronic measurement, laboratory instrumentation and amateur station control. Therefore, over the next few months this column will be devoted to the subject of microcomputers: what they are, how they operate, and what they can and cannot do for the electronic experimenter, engineer or laboratory scientist.

We shall use microprocessor operation and interfacing as a vehicle to probe more deeply into the detailed concepts and techniques of computer interfacing. Please keep in mind that the microprocessor, when complemented by memory, buffers, and input/output (I/O) devices, is as much a computer as its larger and usually faster rivals, the minicomputers and full-size computers. By learning how to interface a microprocessor, you will simultaneously learn the concepts of how to interface a minicomputer or full size computer. The use of interrupts, device selects, software generated strobes, timing loops, and the like are common to all.

To gain full value from some of our forthcoming columns, it would be beneficial to have an understanding of the basic principles of digital electronics. Some very important terms and concepts that you should master include the following: gate, logic element, counter, gated counter, monostable, enable, disable, inhibit, strobe, decoder, multiplexer, demultiplexer, timer, clock pulse,

**By David G. Larsen, WB4HYJ, Peter R. Rony and Jonathan A. Titus.**

Mr. Larsen, Department of Chemistry, and Dr. Rony, Department of Chemical Engineering, are with the Virginia Polytechnic Institute and State University, Blacksburg, Virginia. Mr. Jonathan Titus is President of Tychon Inc., Blacksburg, Virginia.

positive edge, negative edge, flip-flop, latch, bus, Tri-State™, shift register, dynamic RAM, static RAM, ROM, programmable ROM, up/down counter, AND, OR, NAND, NOR, exclusive OR, arithmetic element, and more. Our pair of books on digital electronics, *Bug-books I and II. Logic & Memory Experiments Using TTL Integrated Circuits*, will bring you to the level of understanding in digital electronics required to interface microcomputers; other digital books, such as the pair marketed by Hewlett-Packard in conjunction with their logic lab, will also help you develop the skills that you will need. Digital electronics is a rapidly expanding field, and new texts and reference manuals are appearing at the rate of one every several weeks.

As we currently envision them, future columns will offer a tutorial on the operation and interfacing of a very popular microprocessor, the Intel 8080 8-bit microprocessor, which can perform a simple logic or arithmetic instruction in only 2  $\mu$ sec and can directly address 65,536 different memory locations, each containing eight bits of data. Originally priced at \$360 in quantities of one, you can purchase an 8080 now for about \$50 from selected supply sources and its cost will be no more than \$5 two or three years from today. The 8080 has some important rivals, e.g., the Motorola 6800 and the Fairchild F8, but it is a worthy selection nevertheless. Each microprocessor has its special features. However, the general concepts developed in this column will be applicable to any microcomputer system.

Standing alone, a microprocessor chip can do nothing. It functions only in the context of a microcomputer system, in which appropriate integrated-circuit chips are incorporated to complement the basic function of the microprocessor ( $\mu$ P): to serve as a central processing unit (CPU) in which logic and arithmetic operations and data transfers between register, memory, and the outside world are performed. In some columns, we will need to focus upon a specific microcomputer system. For this purpose, we have chosen a new system that is specially designed to instruct individuals in all of the details of microprocessor operation and interfacing: the Mark 80 microcomputer (fig. 1). This particular system, shown with 4k of solid-state memory and a control panel, is built around the Intel 8080 microprocessor chip. Except for a power supply, it is completely operational. The system is bus structured and has all important inputs and outputs connected to a solderless breadboarding socket, permitting interfacing concepts to be learned, tested, and breadboarded into a digital circuit of your own design.

Material presented here is reprinted with permission from *American Laboratory*. "What's next? Microprocessors," *American Laboratory*, July, 1975; "Microprocessors: Where do they fit?" *American Laboratory*, 1975; "The anatomy of a microcomputer," *American Laboratory*, September, 1975; copyright © International Scientific Communications, Inc., Fairfield, Connecticut, 1975.

## microprocessors: where do they fit?

We would first like to discuss what a microprocessor is and how it fits into the general scheme of computers and controllers that exist today. Eadie, in his book, *Introduction to the Basic Computer*, has defined the term *data processor* as "a digital device that processes data. It may be a computer, but in a larger sense it may gather, distribute, digest, analyze, and perform other organization or smoothing operations on data. These operations, then, are not necessarily computational. Data processor is a more inclusive term than computer."<sup>2</sup>

A *microprocessor* is a single integrated-circuit chip that contains at least 75 percent of the power of a computer. It usually cannot do anything without the aid of support chips and memory, however, and therefore can be distinguished from a *microcomputer*, which is a full operational system based upon a microprocessor chip that contains memory, latches, counters, input/output devices, buffers, and a power supply in addition to the microprocessor chip. A microcomputer may be a "black box" with only a single switch: *operate/reset*. The 8080 microprocessor, a 40-pin LSI chip, is shown in fig. 2. A typical system based upon this chip is shown in fig. 3; the 8080 chip is located on the CPU board on the left.

A microcomputer possesses all of the minimum requirements of a computer. For example:

It can input and output data, which is usually in the form of digital electronic signals. Common I/O devices include teleprinters, CRT displays, paper

fig. 1. The Mark 80 microcomputer system.

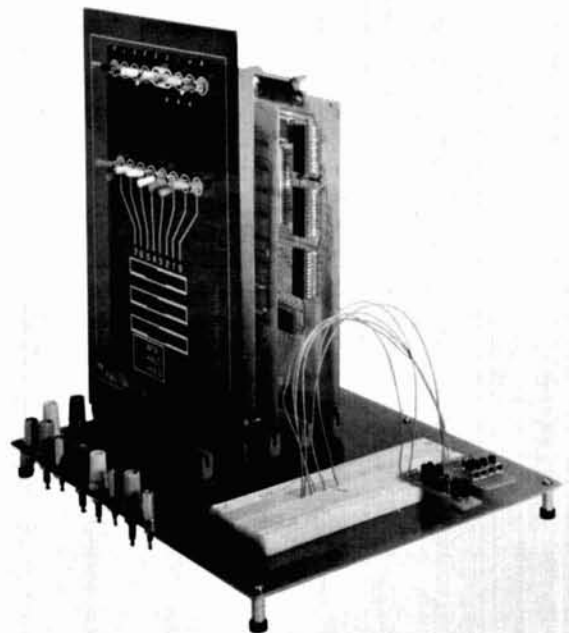

tape readers, floppy disks, magnetic tapes, cassette tapes, laboratory instruments, and process control devices.

It contains an arithmetic/logic unit (ALU) that can perform arithmetic and/or logic operations such as add, subtract, compare, rotate left, rotate right, AND, OR, negation, and exclusive OR.

It contains a minimum amount of "fast" memory such as RAM, ROM, PROM, or core, but usually not cards or paper tape, in which data and program instructions are stored. The data and instructions are stored as 4-bit, 8-bit, 12-bit, or 16-bit words.

It is programmable. The data and program instructions can be arranged in any sequence desired, in contrast to the programmable calculator, in which the precise manner that a keyboard function is executed cannot be changed by the operator.

It is fast, with an ability to execute a simple instruction in ten microseconds or less. All existing microcomputers are digital and TTL compatible, where logic 0 corresponds to ground potential and logic 1 corresponds to +5 volts.

There appears to be some misunderstanding concerning the role of current microprocessors and microcomputers relative to other types of computers. The temptation is great to order a modest microcomputer system and then to surround it with \$5000 worth of I/O devices such as floppy disks and line printers. At this point we would like to provide a bit of insight concerning the most likely role of microcomputers. Fig. 4 graphically depicts where microcomputer applications fit today, and table 1, taken from an article by Riley,<sup>2</sup> depicts the spectrum of computer-equipment complexity from simple hard-wired systems to high-performance general data processing equipment.

Microprocessor and microcomputer applications fall between relay logic and discrete random logic (gates and flip-flops) on one hand and small minicomputers such as the PDP 8A and the LSI 11 on the other. Microcomputers built from microprocessor chips are not as sophisticated as some of the popular minicomputers and cannot easily perform certain types of data processing problems. They are simply not set up at this time to run

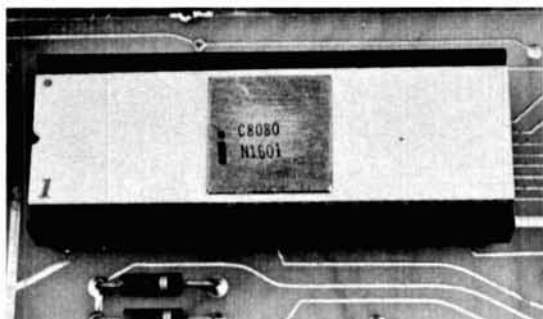

fig. 2. The 8080 microprocessor chip.

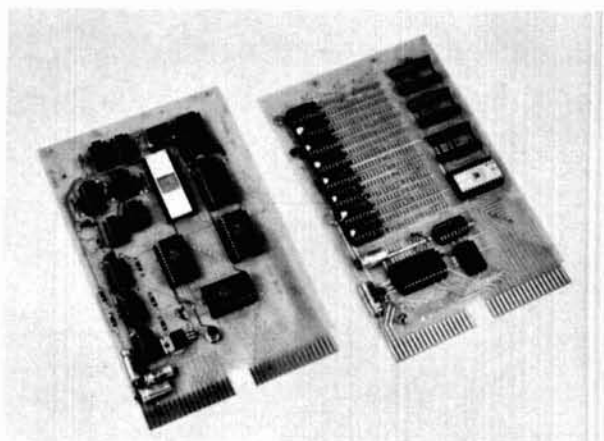

fig. 3. A typical microcomputer system. Shown on the left is the central processing unit (CPU), which consists of input/output buffer chips and miscellaneous control logic. Shown on the right is the microcomputer memory, in this case 1k of RAM and 256 words of ROM. Decoder chips permit the memory to be located anywhere within 65k of microprocessor addressable memory.

FORTRAN, COBOL, or other high-level computer languages. Those microcomputers that can, in principle, handle high-level languages still suffer in comparison with minicomputers supplied by Digital Equipment Corporation, Hewlett Packard, Data General, Varian, and other manufacturers in the amount of available high-level software.

If you want to solve tomorrow's problem, you can consider the purchase of a microcomputer system and develop your own high-level software. If you want to solve today's problem, pay particular attention to software support. Your time is valuable. If you are not careful, software costs can easily equal and exceed the total hardware costs of your data acquisition system.

For the moment, then, it would be more appropriate to call systems built around microprocessor chips *microcontrollers* or *logic processors*. They can sequence events in response to decisions upon input data. As the price of individual microprocessor chips drops from several hundred dollars per chip to \$10 to \$30 per chip, it will be clear that the dominant application for today's microprocessors will be as sophisticated control elements in instruments and machines of all types. We foresee mini-computer-microcomputer and computer-microcomputer hierarchies in which one to twenty instruments, machines, or devices, each containing its own microcomputer, will all be tied to a single minicomputer or computer.

### the anatomy of a microcomputer

The "anatomy" of a typical microcomputer system is shown in fig. 5. This system is based upon the 40-pin 8080 microprocessor chip and possesses all of the minimum requirements for a computer:

It can input and output data.

It contains an arithmetic/logic unit (ALU), located within the 8080 chip, that performs arithmetic and logical operations.



It contains "fast" memory.

It is programmable, with the data and program instructions capable of being arranged in any sequence desired.

It is digital.

Fig. 5 shows the important data paths within the micro-computer. In the sub-sections below, we shall dissect this diagram and discuss each of the individual data paths.

**Random access** A semiconductor memory into which logic 0 and logic 1 states can be written (stored) and then read out again (retrieved).

**Read-only memory** A semiconductor memory from which digital data can be repeatedly read out, but cannot be written into, as is the case for random access memory.

table 1. Spectrum of computer-equipment complexity. Reprinted from *Electronics*, October 17, 1974; copyright © McGraw-Hill, Inc., 1974.

Word length	1	2	4	8	16	32	64
Complexity	hard-wired logic	programmed logic array	calculator	microprocessor	minicomputer		large computer
Application	control			dedicated computation	low-cost general data processing	high-performance general data processing	
Cost	under \$100		\$1000		\$10000	\$100000 and up	
Memory size	very small 0-4 words	small 2-10 words		medium 10-1000 words	large 1000-1 million words	very large, more than 1 million words	
Program	read-only					reloadable	
Speed constraints	real time	slow		medium		throughput-oriented	
Input-output	integrated	few simple devices		some complex devices		roomful of equipment	
Design	logic	logic + microprogram		microprogram macroprogram		macroprogram high-level language software system	
Manufacturing volume	large					small	

**Memory.** Let us first consider the data communication between the 8080 central processing unit, also known as an MPU, and memory. You will require some definitions which will be useful in the ensuing discussion:<sup>1,2</sup>

**Memory** Any device that can store logic 0 and logic 1 bits in such a manner that a single bit or group of bits can be accessed and retrieved.

**Memory cell** A single storage element of memory.

**Memory word** A group of bits occupying one storage location in a computer. This group is treated by the computer circuits as an entity, by the control unit as an instruction, and by the arithmetic unit as a quantity. Each bit is stored in a single memory cell.

**Memory address** The storage location of a memory word.

**Memory data** The memory word occupying a specific storage location in memory, or the memory words collectively located in memory.

**Programmable read-only memory** A read-only memory that is field programmable by the user.

**Volatile memory** In computers, any memory that can return information only as long as power is applied to the memory. The opposite of nonvolatile memory.

**Read** To transmit data from a semiconductor memory to some other digital electronic device. This term also applies to computers and other types of memory devices.

**Write** To transmit data into a semiconductor memory from some other digital electronic device. This term also applies to computers and other types of memory devices. A synonym is *store*.

The 8080 microprocessor employs 8-bit words that are stored in memory with the aid of a 16-bit memory address bus. With the aid of a quick calculation, you can conclude that there exist  $2^{16} = 65,536$  different memory locations which can be accessed by the microprocessor. This access to memory is direct, which means that you don't have to engage in any special tricks or

digital electronic gimmicks to access any given memory location within the 65,536 possible locations. Forty-pin integrated circuit chips do have their advantages, and this is one of them. The total memory capacity of the 8080 microprocessor is known in the trade as "64k." This is far more memory than you will ever need for most applications, but it is nice to know that you have such power in reserve.

Data is transferred between the 8080 CPU and the memory over 8-bit input and output buses, both of which are shown in fig. 5. By input we mean "input into the CPU." The term, "output," is defined in a similar

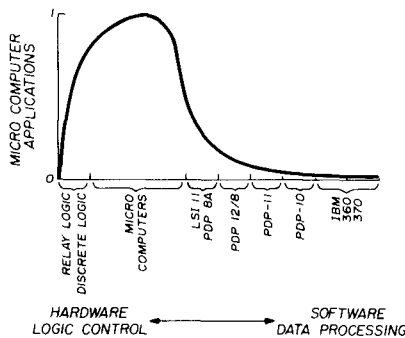

fig. 4. Where microcomputers fit: between relay and discrete logic and inexpensive minicomputers.

fashion. Our point of reference is always the CPU. Data leaving the CPU is always considered to be "output data;" data entering the CPU is always "input data." Fig. 5 shows that the input and output data is transferred between the *accumulator* and memory. This is frequently the case, but in a more detailed look at the 8080 chip, you will discover that data stored in memory is transferred to other internal *registers* within the 8080 chip as well.

The most obvious such register is the *instruction register*, from which the decoding of the instruction occurs. Other registers, known as *general purpose registers* are classified by the letters B, C, D, E, H, and L. We regard the accumulator register to be the heart of the entire microcomputer. Arithmetic and logic operations are always performed to or on the eight bits of data present in the accumulator. All input and output data passes through the accumulator with the aid of two computer instructions called IN and OUT.

Between the 8080 CPU and memory there exists a single output line called memory READ/WRITE. When this line is at logic 1, you are able to READ data into the CPU either from memory or from an external device. When this line is at logic 0, you are able to WRITE data from the CPU into memory or an external output device.

As a final point, you can employ any type of "fast" digital electronic memory device, including random access memory (RAM), read-only memory (ROM), and programmable read-only memory (PROM). What do we mean by "fast" memory? Simply that the memory can perform either a read or write operation during a single

microcomputer instruction. A typical 8080 microcomputer system operates at a clock rate of 2 MHz and a read or write operation takes only 3.5 microseconds. Thus, RAM, ROM, and PROM all need an access time of about one to two microseconds to allow you to take full advantage of the maximum clock speed. Slower semiconductor memories can be used, but the microcomputer will have to wait while a read or write operation takes place.

## data output

The 8-bit output bus between the 8080 CPU and memory also serves as the output data bus to an external output device. When you provide output to an external device, there are several important points to remember:

You must select the specific output device that will receive eight bits of data from the CPU.

You must indicate to this device when output data is available on the output data bus.

The device must capture this output data in a very short period of time, typically 1.5  $\mu$ s.

The third point is perhaps the most important. Keep in mind that the microcomputer is operating at a clock rate of 2 MHz. Each computer instruction is executed in a very short period of time which ranges from 2 to 9  $\mu$ s. Thus, accumulator data designated as "output data" to an external device is not available for very long. You must capture it while it is available. We will discuss the techniques that you would employ in a subsequent column; this topic is certainly among the most interesting topics that can be discussed in the field of computer interfacing.

## data input

The basic considerations that apply to data output also apply to data input into the CPU from an external input device. Thus:

You must select the specific input device that will transmit eight bits of data to the CPU.

You must indicate to this device when the CPU is ready to acquire the input data.

You must insure that the CPU acquires this data in a very short period of time, typically 1.5  $\mu$ s.

## input/output device addressing

The 16-bit memory address bus is time shared so that it can provide, at certain times, an 8-bit device identification number called a *device code*. Eight bits of information allow you to decode  $2^8 = 256$  different devices. When used in conjunction with two output function pulses called IN and OUT, the microcomputer system can address 256 different input devices and 256 different output devices. We might point out here that a "device" can be a complex machine such as a teleprinter or cathode-ray tube (CRT) display, or a simple device such as a single integrated-circuit chip. This is another interesting topic for discussion that we will reserve for a subsequent column.

## microcomputer interrupt

Not shown in fig. 5 is a single input line to the microcomputer that generates a program *interrupt* during microcomputer operation. Such an interrupt would be generated by an external device that wishes to transfer data to or from the computer. This particular topic is quite complex, and it will be a number of months before we tackle it in this column.

The above is about the best that we can do to describe the general "anatomy" of a microcomputer in one-thousand words or less. Microcomputers are fascina-

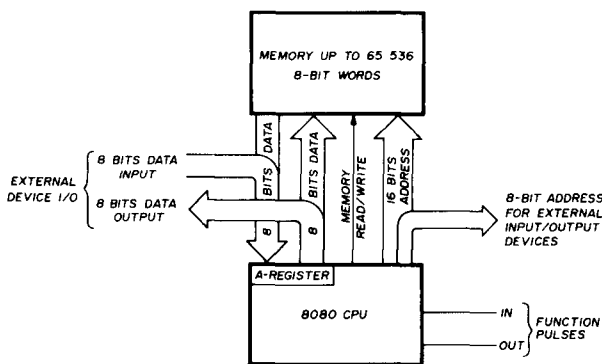

fig. 5. A typical 8080-based microcomputer system.

ting machines. They are small and relatively inexpensive, so you are less likely to be intimidated by them. They are far simpler than their minicomputer and computer counterparts and can be readily repaired by the simple process of chip substitution. They appear to be the proper answer to your childhood question, after the *Erector Set*, what?

If you do not wish to stretch out your learning process on microcomputers for twelve months or more, we might indicate that we have just completed *Bugbook III* entitled *Microcomputer Interfacing Experiments Using the Mark 80<sup>®</sup>, an 8080 System*. It contains approximately 600 pages of text and experiments on interfacing and programming 8080-based microcomputers.<sup>6</sup>

### references

1. D. G. Larsen, P. R. Rony, and J. A. Titus, *Bugbook I and II. Logic & Memory Experiments Using TTL Integrated Circuits*, E&L Instruments, Inc., Derby, Connecticut, 1974 (\$16.95 for the pair from Ham Radio Books, Greenville, New Hampshire 03048.)
2. D. Eadie, *Introduction to the Basic Computer*, Prentice-Hall, Inc., Englewood Cliffs, New Jersey, 1968.
3. W. B. Riley, "Technology Update: Computers," *Electronics*, October 17, 1974, page
4. R. F. Graf, *Modern Dictionary of Electronics*, Howard W. Sams & Co., Inc., Indianapolis, 1972.
5. J. Blukis and M. Baker, *Practical Digital Electronics*, Hewlett-Packard Co., Santa Clara, California 1974.
6. D. G. Larsen, P. R. Rony, and J. A. Titus, *Bugbook III: Microcomputer Interfacing Experiments using the Mark 80 an 8080 System*, E&L Instruments, Derby, Connecticut, 1975 (\$14.95 from Ham Radio Books, Greenville, New Hampshire 03048).

ham radio

# SRI-1000 Microcomputer

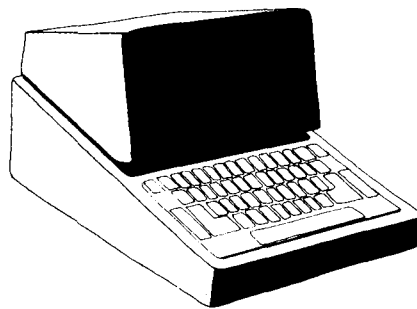

The SRI-1000 is designed around "PACE" National Semiconductors powerful 16-Bit Microprocessor. The system is complete and allows the user to connect it to external devices immediately. With the addition of the SRI-1020 plug in board, it will display data on a standard T.V. Monitor, the SRI-1040 for example. Also, by plugging in the SRI-1010 board, the system can "talk" to most any Cassette Tape Recorder for loading programs or storing information. It also allows the SRI-1000 to communicate with other systems via phone lines, etc. The SRI-1000 is controlled entirely from the keyboard, making it extremely flexible. The main board will accept up to six additional plug in options, and the power supply is adequate to handle both the SRI-1000 and the options. It is housed in a compact desk-top enclosure, with room on top to mount a Video Display.

The SRI-1000 includes the following . . .  
**16-BIT MICROPROCESSOR — 4K (WORDS) STATIC RAM**  
**EXPANDABLE PROM — UP TO 1K (WORDS) —**  
**INTERNAL POWER SUPPLY**  
**53 KEY KEYBOARD**  
**RS-232 TTL AND 20 MA. TTY CURRENT LOOP**  
**INTERFACE**  
**REAR PANEL CONNECTOR ACCESS**  
**EDITOR, ASSEMBLER AND DEBUG SOFTWARE**

All the above combine to make for a versatile and very powerful computer system that can handle the following with ease, and more.

**Business Applications** — Can be used for inventory control, payroll computations and bookkeeping. **Educational** — Acquaint students with computer systems and programming techniques. **Security Field** — Check and verify security badges, monitor intrusion devices, fire and gas detectors. Then identify the problem, indicate the time and location and read it out on a screen or line printer. **Hobbyist** — Play games such as "chess", or to help you with experiments.

**SRI-1000 MICRO COMPUTER SYSTEM**  
 (16-Bit Processor) . . . . . \$599  
**SRI-1010 CASSETTE (MODEM) INTERFACE** . . . . . \$75  
**SRI-1020 VIDEO INTERFACE** . . . . . \$175  
**SRI-1040 12" R.F. VIDEO MONITOR** . . . . . \$125  
**SRI-1080A ADDITIONAL STATIC RAM 2K (WORDS)** \$200

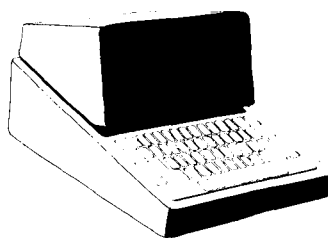

## SRI-200 RTTY TERMINAL FOR AMATEURS

**RTTY TERMINAL . . . from SYSTEMS RESEARCH, INC.**  
 You may order the system complete — or any of five modules . . . whichever suits your needs best.

Special Offer valid only through Jan. 31, 1976 — Purchase SRI-200 and SRI-210. Receive SRI-230 and SRI-240 at no extra cost.

**SRI-200.** Terminal unit. Need only be connected to the output of any RTTY converter and to any monitor (either video or RF) to copy teletype. Price \$399. Standard T.V. Set.

**SRI-210.** Keyboard assembly. Allows you to transmit RTTY by simply connecting the output of the 210 to any AFSK or FSK unit. Price \$199.

**SRI-220.** Video display monitor. Mounts on top of the terminal to make a compact desk top unit. Price \$125.

**SRI-230.** RTTY converter board. Plugs directly into terminal main board. Accepts audio from any receiver.

**SRI-240.** AFSK board. Plugs directly into keyboard assembly main board.

All items assembled and tested. Allow approx. 30-90 days delivery time. All items shipped postpaid.

Send cash or check with order or use charge cards.

Send NOW for FREE ADDITIONAL INFORMATION

**Systems Research, Inc.**

P.O. Box 151280

Salt Lake City, Utah 84115

(801) 942-1093



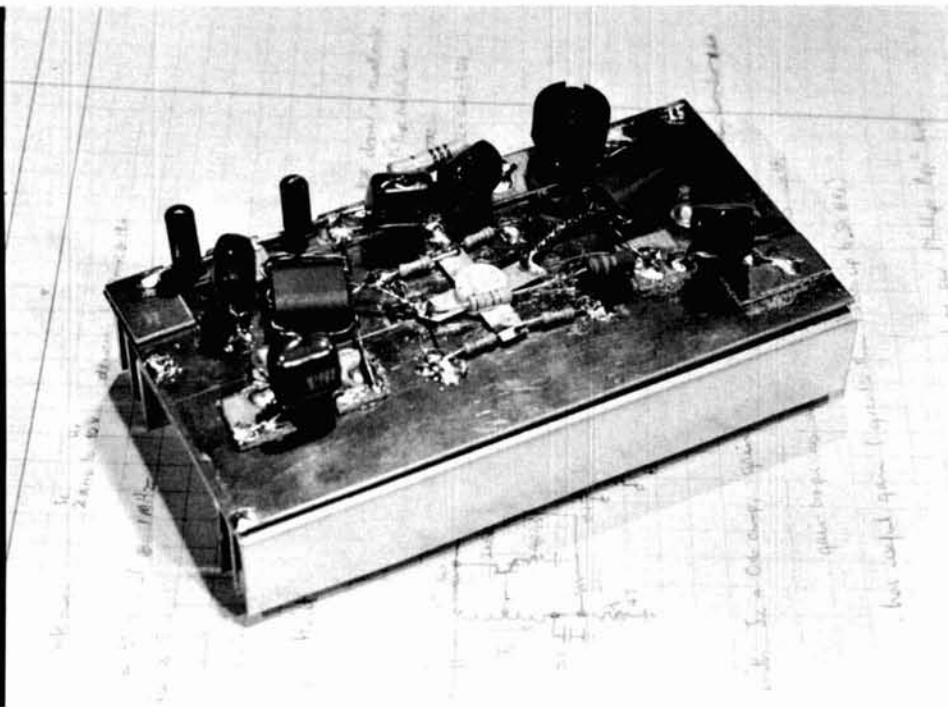

## four-watt wideband linear amplifier

A stable  
rf amplifier  
for QRP use  
or as a driver  
for higher-power  
linear amplifiers  
over the frequency  
range from 300 kHz  
to 30 MHz

There is no problem these days in building high-frequency, transistorized ssb exciters that produce outputs in the milliwatt range. However, there seems to be a dearth of information on how to get these low-level signals up to a more useful level. Articles I've seen in the amateur magazines seem mostly to use one of two extreme methods. One is to make use of the rather exotic high-priced transistors designed especially for linear power amplification; the other is to use some of the newer audio power transistors — usually with great difficulty and often with not very satisfactory results.

### features

This linear amplifier uses the widely available and inexpensive (about \$7.00) 2N5590 transistor to produce a power output of 4 watts across the high frequency rf range. This power level is suitable for the output of QRP rigs or as a driver for a final amplifier in the hundred-watt range.\*

\*This amplifier will drive the high-power linear amplifier described by Chalmers<sup>1</sup> to full output.

J. A. Koehler, VE5FP, 2 Sullivan Street, Saskatchewan, Canada S7H-3G8

The amplifier gain is flat over the high-frequency rf range, being only 3 dB down at 300 kHz and 30 MHz. In fact, the amplifier still produces useful gain at six meters. The exact gain will depend somewhat on the transistor used, but the version I built had a midband gain of 22 dB. This means that full output on the amateur bands up to 15 meters can be obtained with only 25 milliwatts of drive; 40 milliwatts is required at ten meters. The amplifier output may be either shorted or left open indefinitely with no damage even with full drive. The amplifier is also very stable and shows no tendency to oscillate.

### circuit

The amplifier schematic is shown in fig. 1. The stability and wide frequency response are achieved by adding considerable negative feedback to an otherwise conventional broadband amplifier. The small inductance in series with the 560-ohm feedback resistance decreases the feedback at the higher frequencies. The exact value is not critical. About 25 turns of number 30 (0.25mm) wire closewound on a 1/2-watt resistor will do very well.

The amplifier operates in the class-A mode, and the transistor has a quiescent power dissipation of 5 watts. A fairly efficient heat sink is required. While commercial

heatsinks are good, an acceptable one can be made from three sheets of 0.06-inch (1.5mm) aluminum formed and assembled as shown in fig. 2. After all holes are drilled, they should be deburred so the pieces will make good contact with each other. It's a good idea to put silicone grease or heatsink compound between the pieces before final assembly.

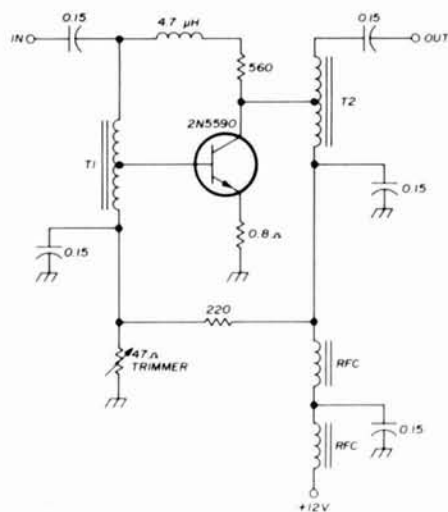
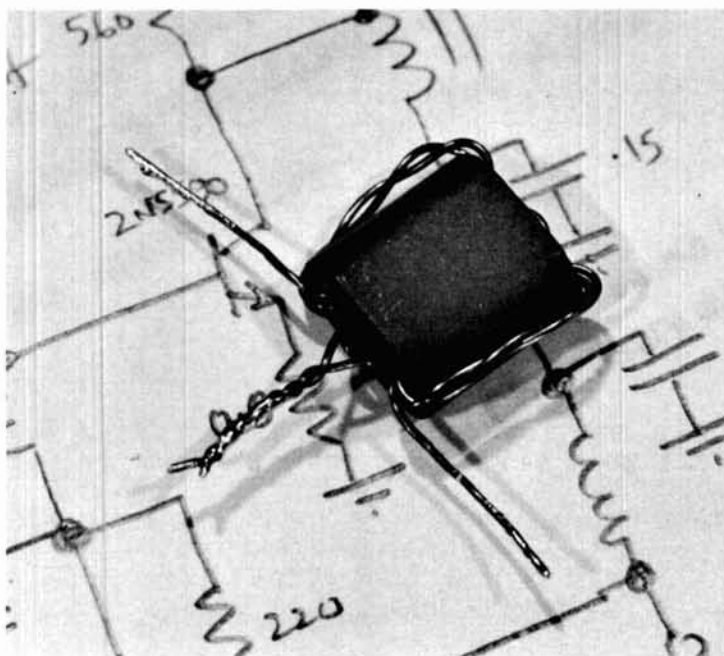

fig. 1. Rf amplifier schematic. T1, T2 are wound on two-hole balun cores as found in TV-set input circuits. Emitter resistor is made from four 3.3-ohm, 1/4-watt resistors in parallel. All capacitors are 100-volt plastic; rf chokes are 1 or 2 turns through a ferrite bead.

One of the broadband transformers used in the input and output circuits.



### construction

The circuit is built on a piece of single-sided circuit-board material mounted copper side up on the heatsink. A large clearance hole for the transistor is drilled in the center so that the transistor can be mounted directly on the heatsink. It's important to put silicone grease or heatsink compound on the mounting surface of the transistor before assembly. It's also important *not* to overtighten the transistor mounting nut. Components are mounted between pads of PC material approximately 0.39 x 0.39 inch (1 x 1 cm) cemented to the main circuit board. Pad locations may be found by laying out the components you wish to use on the board. The general appearance of the amplifier (before adding components) is shown in fig. 3.

The transistor tabs are fragile, so the transistor should be mounted in its final position first and the components soldered to the tabs later. *Do not* reverse this order or the tabs will be stressed when you tighten the tran-

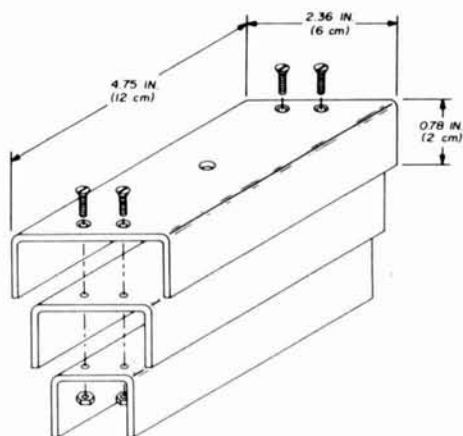

fig. 2. Method of constructing transistor heatsink. Aluminum sheet is formed to approximate dimensions shown, then assembled. Hardware is 4-40 (M3). Top holes are countersunk. Transistor stud clearance is drilled after assembly.

sistor mounting nut. The 0.8-ohm emitter resistor must have a very low inductance, which may be achieved by paralleling several higher-value resistors. I used four 3.3-ohm, 1/4-watt resistors soldered symmetrically between the emitter tabs and the ground plane as shown in the photograph.

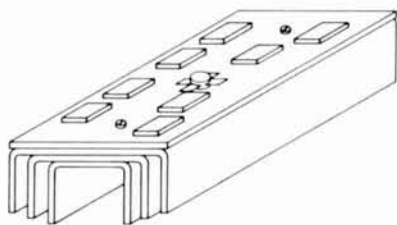

Fig. 3. Printed-circuit board and heatsink mounting details. Mounting pads for components are made of PC board material.

The input and output transformers are wound on two-hole balun cores as found in TV sets. The ones I used are manufactured by Phillips; their type number is 4322-020-31520. The windings are made by twisting two pieces of number 22 (0.6mm) enamelled wire together about three twists per inch (one twist per cm). This twisted pair is then wound through the core as

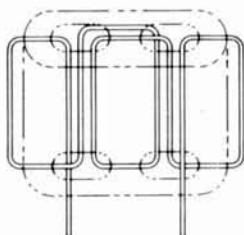

fig. 4. Transformer winding details. No. 22 (0.6mm) enamelled wire twisted pair is wound through a two-hole balun core.

shown in fig. 4 and the photograph. Using an ohmmeter to identify the wires, one end of one wire is connected to the opposite end of the other wire, which is the center tap of the transformer. The wide frequency response of the amplifier is due to these transformers, and the general method of construction should be followed, although wire size, number of twists and number of turns through the core are not too critical.

Chokes in the main supply line are made by winding one or two turns through any of the widely available ferrite beads. I used one turn through a two-hole bead for each of the chokes. Large values of inductances are not required here since the power-supply line operates at very low impedance.



Underside of amplifier. Emitter-resistor assembly is shown paralleled between emitter tabs and ground plane. Input and output transformers are at extreme right and left.

No tuning is required, so the amplifier is made ready for use merely by adjusting the quiescent current level. First set the 47-ohm trimmer to minimum resistance then connect the 12-volt power supply and adjust the trimmer so that the total amplifier current drain is 0.4 ampere.

At the one-watt output level, the second harmonic measured 30 dB down with respect to the fundamental. I wasn't able to measure the intermodulation distortion with the test equipment I had available. From the measured performance of similar amplifiers,<sup>2</sup> I'd expect it to be about -40 dB. For CW use, the quiescent current may be lowered to reduce wasted power; however, the output harmonic content will increase and the overall gain will decrease.

#### references

1. S. Chalmers, "High-Power, Solid-State Linear Amplifier," *ham radio*, August, 1974, page 6.
2. M. J. Kloppen, "Single-State Wideband SSB Driver Modules," Phillips Application Report ECO-7113, 1971.

ham radio

# ATLAS' SUCCESS HAS MANY FACETS

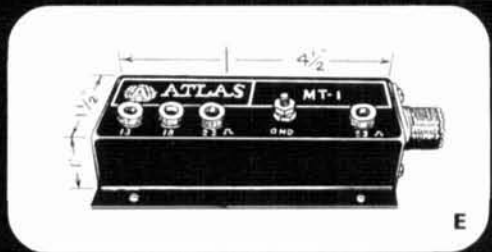
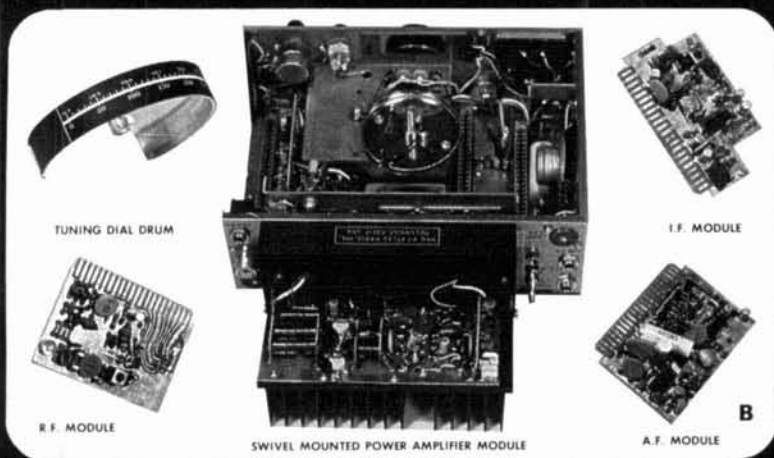
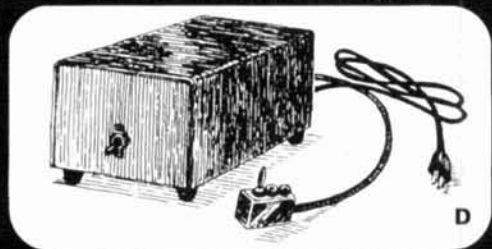
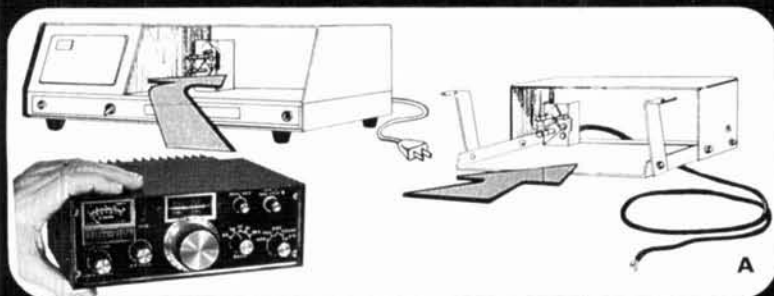

## ONE OF THESE IS MODULAR DESIGN:

**A** The unique modular design of Atlas radio equipment offers many advantages. The specially designed rear connectors in the Plug-in Mobile Mount and AC Console enable you to go from fixed operation to mobile in seconds by simply sliding your Atlas transceiver into the appropriate mount. All necessary connections to power input, antenna, and mic jack are made immediately. In the AC Console, the internal speaker is automatically disconnected and the front facing speaker in the console is turned on. This is the simplest way we know of to go from fixed to mobile operation or vice versa.

**B** The RF, IF, and AF circuits are all on easily accessible plug-in boards, so that service on your Atlas transceiver, when required, is quick, easy and inexpensive.

**C** Adding the Atlas Model 10x Crystal Oscillator provides substantially extended frequency coverage for MARS operation. Frequency coverage with the 10x is: 1700-3000 kHz (Model 215x only), 3000-5200 kHz, 5800-10,000 kHz, 13,900-14,900 kHz, 20,600-21,600 kHz, 27,500-30,000 kHz (Model 210x only). The 10x has vernier frequency control, and plugs into the back of the Atlas transceiver with cable provided.

**D** The Atlas Portable AC Supply (Model 200-PS) is ideal to bring along on those vacations or business trips when you want to operate from your motel room or cabin. It weighs just 7 lbs., measures 5 1/2"x3 1/2"x6 1/2".

**E** Improve your mobile antenna efficiency substantially by installing the Atlas MT-1 Mobile Antenna Matching Transformer. This device was especially designed to provide a better impedance match between mobile antennas and the new solid state transceivers, including of course, the Atlas solid state transceivers. Has broad band design, 1.8-30 MHz, 500 watt power rating, with choice of 4 impedance taps for clearly matching the base impedance to 52 ohms.

Don't let the small size (9 1/2"x3 1/2"x9 1/2") and light weight (7 lbs.) of the Atlas 210x and 215x fool you. There is no other transceiver on the market with as many outstanding features. It is completely solid state design, totally broadband requiring no transmitter tuning or loading controls, provides 200 watts P.E.P. input, and offers the ultimate in sensitivity, selectivity, and overload immunity.

<b>Model 210x or 215x</b> .....	<b>\$649.</b>
<b>AC Console 110/220V</b> .....	<b>\$139.</b>
<b>Portable AC Supply 110/220V</b> .....	<b>\$ 95.</b>
<b>Plug-in Mobile Mount</b> .....	<b>\$ 44.</b>
<b>10x Osc. less crystals</b> .....	<b>\$ 55.</b>
<b>MT-1</b> .....	<b>\$ 24.</b>



**ATLAS  
RADIO INC.**

417 Via Del Monte Oceanside, CA 92054  
Phone (714) 433-1983

*For complete details see your Atlas dealer, or drop us a card and we'll mail you a brochure with dealer list.*

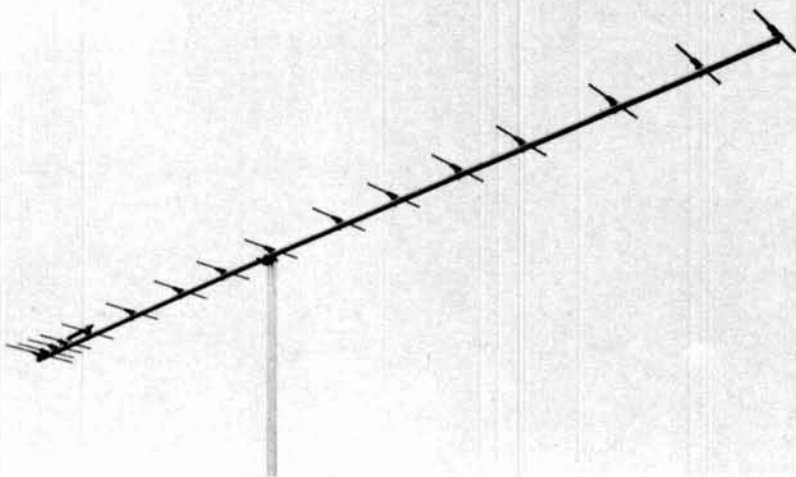

## high gain yagi for 432 Mhz

A new long-boom  
16-element Yagi design  
for 432 MHz  
that provides  
15 dB gain  
over a dipole

For years the amateur uhf community has been trying to come up with a reproducible, high-gain Yagi beam for 432 MHz. At one time it was generally agreed among amateurs that the dimensions of a really long uhf Yagi antenna were so critical that it was impossible to build a practical, reproducible, high-gain, multi-element beam, and most uhf operators switched to the less critical colinear array. Unlike the long-boom Yagi, the colinear is a low-Q antenna, so none of the dimensions are overly critical and it is easily reproduced for uhf operation.

However, as has been pointed out by Ed Tilton, W1HDQ,<sup>1</sup> it is possible to build Yagi antennas for 432 MHz (and other uhf frequencies) if *all* dimensions are properly scaled. Most experimenters scaled element length and spacing, but failed to scale either the element or boom diameter — this resulted in antennas that exhibited little more gain than a dipole, or worse. W1HDQ's 11-element, 432-MHz Yagi design was the first that proved to be reproducible, and although it uses a wooden boom, large numbers are being used by amateurs on the 432-MHz band. The gain of the Tilton Yagi has consistently measured about 13 dBd (gain over a dipole).

Other successful 432-MHz Yagi designs are those of W0EYE<sup>2</sup> and K2RIW.<sup>3</sup> W0EYE's 15-element design, which uses a 10-foot (2.9m) metal boom, attracted wide attention, but not everybody who tried to build it was successful. K2RIW's 13-element Yagi, which uses insulated elements (8-foot [2.4m] boom), has been quite popular in the East, and has consistently been shown to provide about 15 dBd gain.

Described here is another long-boom Yagi for 432 MHz which provides about 15 dBd gain. This has been confirmed at antenna measurement contests on both the East and West Coast. This Yagi, which was designed by Mike Staal, W6MYC, and Mel Farrer, K6KBE, of KLM Electronics, is based on successful design techniques

By Ken Holladay, K6HCP, 2140 Jeanie Lane, Gilroy, California 95020



proven on hf and vhf and uses a broadband driven structure which consists of three elements (fig. 1). This provides a reasonable operating bandwidth and ease in coupling to the 12 directors and one reflector. The broadband structure, in addition to providing optimum coupling to the directors, is the key to reproducibility. Small variations in dimensions can be tolerated without significantly changing the operating characteristics of the antenna.

### construction

As is shown in fig. 1, the antenna is based on a 1-inch (25cm) diameter boom, 12-feet (3.7m) long. Each of the elements is 3/8-inch (9.5mm) diameter aluminum tubing, insulated from the boom except for the single mounting screw (this type of element mounting *must* be used for the dimensions given in fig. 1). The driven elements are cross connected using 1/4-inch (6.5mm) wide aluminum strap. The feedpoint impedance is 50 ohms (balanced) and must be connected to a balun using low-inductance copper strap 5/16 inch (8mm) wide.\* To prevent aluminum-to-aluminum and aluminum-to-copper corrosion, all joints should be coated with *Penetrox A* or equivalent weatherproofing. An acceptable balun can be made as described by K6HCP and WA6GYD in the ARRL *Radio Amateur's VHF Manual*.<sup>4</sup>

### performance

At my station I have two of these antennas mounted side by side, and they have provided the expected results. Los Angeles is about 300 miles (483km) away, over mountainous terrain, and good solid contacts on 432 MHz are a nightly occurrence. Activity on 432 is starting to increase, and I feel confident that this new antenna, which is easy to build, will do a great deal to stimulate growth on this band.

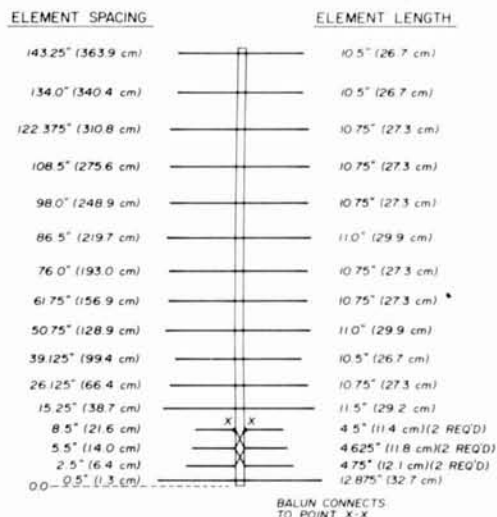

fig. 1. Layout of the 16-element Yagi for 432 MHz. Elements are 3/8" (9.5mm) diameter aluminum tubing, insulated from the boom except for the single mounting screw as shown in fig. 2.

\*For those readers who do not have the time or material to build their own, this antenna is available from KLM Electronics, 17025 Laurel Road, Morgan Hill, California 95037.

### references

1. Ed Tilton, W1HDQ, "Antennas for 220 and 420 MHz," *The Radio Amateur's VHF Manual*, ARRL, Newington, Connecticut, 1972, page 208.
2. Don Hilliard, W0EYE, "15-Element Yagi for 432 MHz," *QST*, January, 1972, page 96.
3. Dick Knadle, K2RIW, "13-Element Insulated Yagi for 432 MHz," *The ARRL Antenna Handbook*, 13th edition, 1974, page 243.
4. Ken Holladay, K6HCP, and Don Farwell, WA6GYD, "Making and Using Baluns," *ARRL Radio Amateur's VHF Manual*, page 170.

ham radio

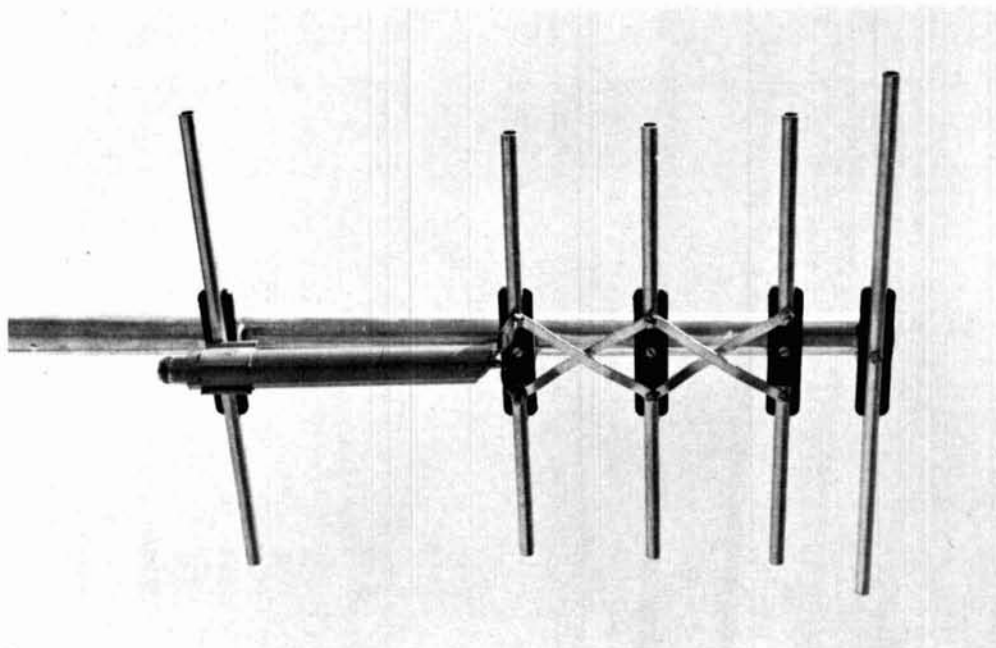

fig. 2. First five elements of the high-gain 432-MHz Yagi, showing element mounting and balun installation. The three-element, cross-connected driven structure is at the center.

# Hy-Gain 270

## 2-meter antenna

# A great mobile that's also a great base.

The same state-of-the-art qualities that make the Hy-Gain 270 antenna a great 2 meter mobile, make it a great 2 meter base.

Hy-Gain design has eliminated hard tuning, high VSWR and poor pattern due to irregular ground plane. The 270's slim mobile configuration makes it ideal for apartment or urban installations where space is at a premium.

Fiberglass 270 develops gain through the use of 2 stacked 5/8 wave radiators with a self-contained 1/4 wave decoupling system. Gain that helps reach distant repeaters.

Since the antenna and feedpoint are sealed in fiberglass, the Hy-Gain 270 delivers top performance year after year without corrosion loss.

Get all the 2 meter base you need, for the price of a 2 meter mobile. The great Hy-Gain 270.

- 6 db gain
- 250 watt rated
- 144-148 MHz
- VSWR less than 1.5:1 at resonance, 6 MHz bandwidth
- 96" high
- Completely factory tuned
- 50 ohm input impedance
- Complete with 18' coax and PL-259

For information on Hy-Gain 2 meter and other amateur products contact your Hy-Gain distributor or write.

Hy-Gain Electronics Corporation: 8601 Northeast Highway Six; Lincoln, NE 68505; 402/464-9151; Telex 48-6424 • Branch Office and Warehouse; 6100 Sepulveda Blvd., #322; Van Nuys, CA 91401; 213/785-4532; Telex 65-1359 • Distributed in Canada by Lectron Radio Sales, Ltd.; 211 Hunter Street West; Peterborough, Ontario

 **hy-gain**<sup>®</sup>

# The 280 series.

## No-nonsense, no-corrosion 10-80 meter mobile antennas from Hy-Gain.

Now from Hy-Gain, a new concept in tip-changing Ham antennas. The 280 series is designed with no-nonsense, one piece fiberglass masts and tough, one piece baked fiberglass coils. You get maximum power handling capability, minimum heat drift, and no loss to corrosion. Yet, it's lighter than aluminum and just as strong.

All five coils are mandrel wound for absolutely consistent performance, imbedded in

fiberglass, then baked to make them impervious to weather. Tough ABS end caps and solid brass coil fittings keep performance in, corrosion out.

Whips are 17-7 ph stainless, the finest antenna steel, and are literally indestructible in normal use.

Nominal 52 ohm impedance on all bands. Any coax length will work. Heavy duty, chrome plated mast and whip fittings. 3/8" x 24 base stud fits all standard mounts.

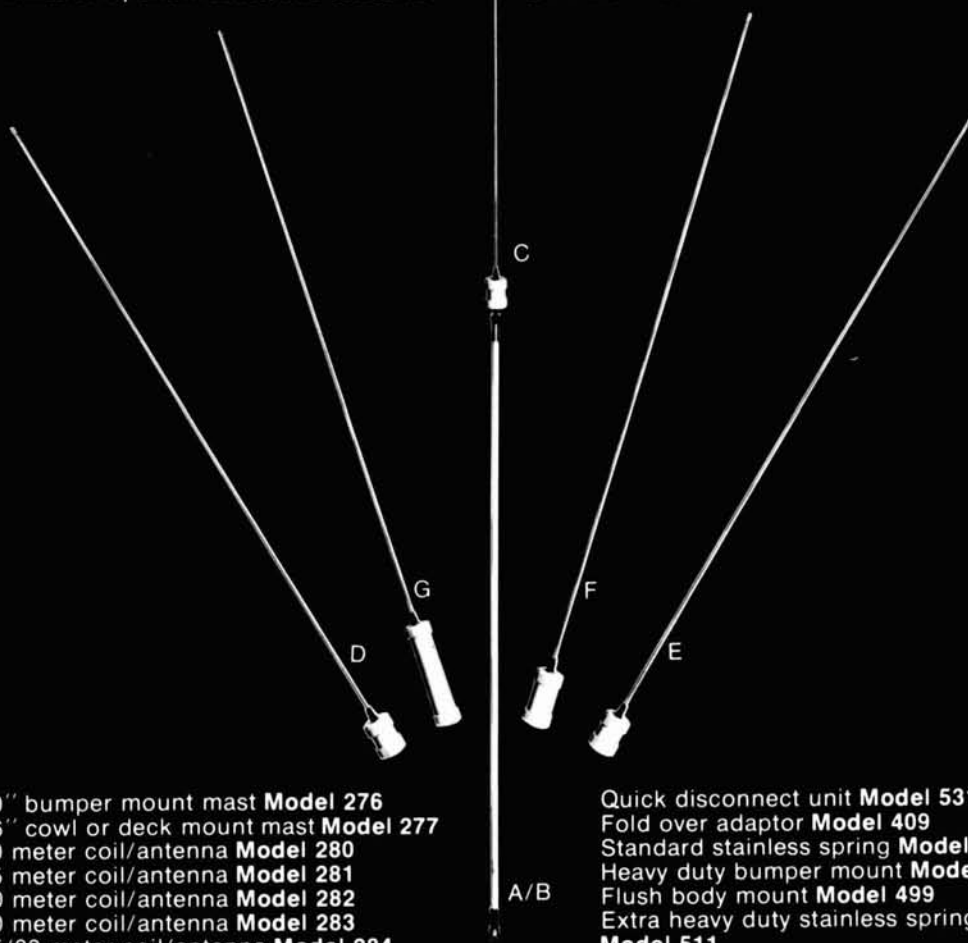

- (A) 60" bumper mount mast **Model 276**
- (B) 36" cowl or deck mount mast **Model 277**
- (C) 10 meter coil/antenna **Model 280**
- (D) 15 meter coil/antenna **Model 281**
- (E) 20 meter coil/antenna **Model 282**
- (F) 40 meter coil/antenna **Model 283**
- (G) 75/80 meter coil/antenna **Model 284**

- Quick disconnect unit **Model 531**
- Fold over adaptor **Model 409**
- Standard stainless spring **Model 492**
- Heavy duty bumper mount **Model 415**
- Flush body mount **Model 499**
- Extra heavy duty stainless spring **Model 511**

**hy-gain**<sup>®</sup>

Hy-Gain Electronics Corporation; 8601 Northeast Highway Six; Lincoln, NE 68505; 402/464-9151; Telex 48-6424  
Manufacturers and distributors of more than 300 fine broadcast communications products.



# telephone controller for remote repeater operation

Using a modified  
RTTY autostart circuit  
to activate  
a repeater  
without a telephone

An earlier issue of *ham radio* described a telephone controller that could be used to turn any device on and off, such as a repeater.<sup>1</sup> Hopefully you've already read that article, so we won't go into the actual telephone controller; instead we'll show you how to operate the controller without a telephone. Many have asked us how this can be done, so we designed a circuit that will decode a tone and change it to a dc voltage that will allow the controller to be operated without a telephone.

We already had a circuit board that would do this.\* This circuit was originally designed for RTTY autostart, and by simply retuning it to a chosen audio frequency, we found that it worked perfectly as a tone decoder. The RTTY autostart circuit is shown in fig. 1. All we had to do was omit the relay, bring out the lead from Q2 collector, and route it to the telephone controller junction

\*Available from Circuit Board Specialists, 3011 Norwich Avenue, Pueblo, Colorado 81008. RTTY autostart printed circuit board \$3.50 each. Complete kit, less power supply (+18 to 24 Vdc) \$14.50. (Specify approximate tone frequency.)

tion of U1, pins 14 and R8.<sup>1</sup> On the original telephone controller you can omit Q1, Q2 and Q3; CR1, CR2 and CR3; R1-R7; C1-C4; and K1. (These parts were used to validate the telephone line only.)

The circuit is a tone decoder that turns transistor Q1 on and off. A tone of your choice is fed into the circuit from your receiver through R1 and decoupling capacitor C1. The tone is decoded by L1, C2. Q1 is a voltage amplifier. The amplified tones are rectified by diodes CR1 and CR2. The resulting dc voltage is fed to the base of Q2. Capacitor C7 requires about two seconds to charge and discharge, resulting in Q2 turning on and off at a rate similar to the ring rate from the telephone, as decoded by the original circuit in the telephone controller. Therefore, assuming the telephone controller circuit has been properly programmed, one would ring three times, hang up, wait twenty seconds, and ring three more times. The same thing would be done with the tone encoder on your mobile or base rig; i.e., push the button three times for one second each (or longer); stop; wait twenty seconds; then push the tone button three more times.

The only thing that will take a little time is tuning the toroid for the audio frequency you desire, which is done with the aid of an oscilloscope or vtvm on the ac volts scale.

Put the plus lead of the scope or vtvm to the gate of Q1. Dc voltage need not be applied to the circuit. Apply your desired tone to the input and open R1 all the way. Adjust C2 for maximum ac volts or peak-to-peak voltage on the oscilloscope. Remember, the better the tuning, the narrower will be the bandpass.

After it's all hooked together, apply a dc voltage between +12 and +24 volts to the decoder board and

By Robert C. Heptig, KØPHF, Robert D. Shriner, WAØUZO

Robert C. Heptig, KØPHF, P.O. Box 969, Pueblo, Colorado 81002, Robert D. Shriner, WAØUZO, 1740 E. 15th St., Pueblo, Colorado 81001.

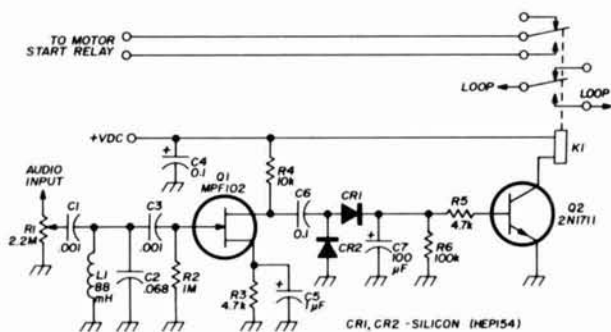

fig. 1. RTTY autostart circuit, which is used with IC U1, the SN7490 in the original article (reference 1), as a tone decoder. A tone of your choice is fed into the circuit through R1, C1 and is decoded through L1, C2. K1 is a Potter & Brumfield SC-4332.

telephone controller board, then test it as described in reference 1 (with the exception of the validating circuit). Adjust R1 of the decoder board to allow just enough audio to do the job with respect to the amount of deviation of your tones.

### tone access

Just for the fun of it we added a tone access for your repeater to the circuit. Simply put the relay back into the circuit of the RTTY autostart as shown in fig. 1 and wire it into your repeater as shown in fig. 2. In this configuration the COR cannot be keyed unless a brief tone is applied to your carrier, which will cause the modified RTTY autostart circuit to provide a ground for

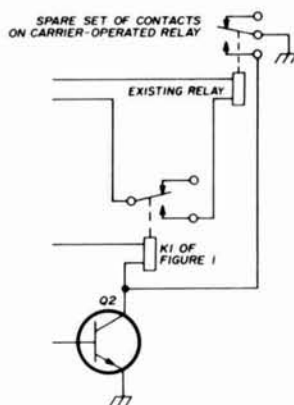

fig. 2. Tone-access circuit for repeaters. A brief tone applied to your carrier causes the modified autostart circuit to ground your COR as long as the carrier is present.

your COR; then a spare set of contacts on your COR will maintain ground as long as your carrier is present. By tuning the decoder as a broadband amplifier (increase values of C1 and C3), this circuit could be used for a vox-operated repeater. With a little imagination, you can probably come up with many possibilities for this decoder.

### reference

1. Robert C. Heptig, K0PHF and Robert D. Shriner, WA0UZO, "Automatic Telephone Controller for Your Repeater," *ham radio*, November, 1974, page 44.

ham radio

## K-ENTERPRISES

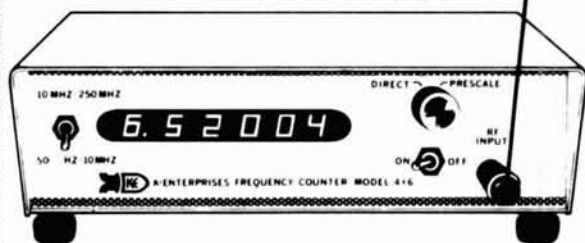

**MODEL 4X6C**  
50 HZ—250 MHZ ..... \$270.00

**300 and 500 MHZ PRESCALERS**  
**FREQUENCY STANDARDS**  
**MARKER and PEAKING GENERATORS**  
**POWER SUPPLIES AMPLIFIERS**  
**WRITE FOR FREE CATALOG**



Phone:  
405-273-9024



**K-ENTERPRISES**

1401 N. Tucker

Shawnee, Okla. 74801

## INTERNATIONAL MORSE DECODER

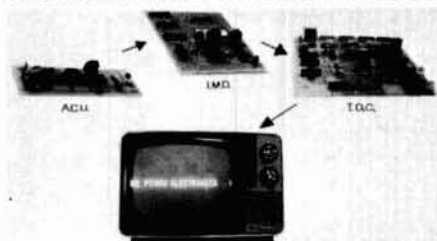

International Morse Code  
International Morse Code IN  
Parallel ASCII OUT **\$73**

Television Display Circuit  
ASCII IN; Display a single row of up to 30  
characters on your TV screen. **\$118**

Audio Converter Unit  
Couple your receiver to the International  
Morse Decoder; Two stage active filter plus  
level detector; Can also be used to drive an  
audio oscillator for static free CW reception.  
**\$19**

The above circuit boards are shipped assembled and tested

**PIÑON**  
**ELECTRONICS**  
P. O. BOX 2192  
MESA, ARIZONA 85204

# Who the best 2-meter And saves you

## You do!

**Heathkit state-of-the art  
2-M transceiver with true  
digital frequency  
synthesizer:  
Build it yourself  
at an incredibly  
low price  
...just  
\$289.95**

Unmatchable feature-packed value. Just compare: True digital frequency synthesizer for unlimited frequency selection with no crystals to buy. Lever switched frequency selection with digital read-out—just flip the front panel lever controls to select any frequency in any 2MHz segment of the 144 to 147.995 MHz operating range. LED status lights to let you know that the synthesizer is "locked" on the frequency you dialed and whether the channel is in



use. Automatic offset plus built-in tone encoder so you can work repeaters. A minimum of 10 watts output and infinite VSWR without failure. A hot receiver with 0.5  $\mu$ V sensitivity and Schmitt-Trigger squelch with a threshold of 0.3  $\mu$ V or less.

The HW-206 is also one of the smallest synthesized rigs available. And it's easy to build. There are just 5 circuit boards, and alignment requires only a VTVM. A frequency counter helps, but you can do the job without one.

Like we said, when you want the best, and you want to save, you want a Heathkit rig.

**Kit HW-206 Transceiver..... \$289.95**  
plus shipping  
**Kit HWA-202-1 Optional AC power supply \$32.95**  
plus shipping

# builds transceivers? money, too?

**Heathkit handheld  
2-M transceiver:  
Outstanding  
versatility  
and value  
at an  
amazingly  
low price,  
just  
\$169.95**

(Optional Auto-Patch Encoder  
shown installed. \$39.95)



The HW-201 is a 5-channel transceiver which has a repeater Simplex offset switch for each channel. The kit comes with a crystal which will work 146.94 MHz Simplex and .34-.94 repeater. Output is one watt minimum with 0.005% (or better) stability. And the unit has true FM and a built-in separate microphone for better audio. A rechargeable nickel-cadmium battery pack and charger are included at no extra cost. An optional Auto-Patch encoder gives you the added versatility of placing telephone calls through repeaters set up for touch tone operation.

- Kit HW-201 Handheld Transceiver . . . \$169.95**  
plus shipping
- HWA-2021-2 Carrying case & strap. . . \$ 12.95**  
plus shipping
- Kit HWA-2021-3 Auto-Patch encoder. . . \$ 39.95**  
plus shipping
- HWA-2021-4 Crystal certificate (only  
one required for each transmit/  
receive channel). . . . . \$ 6.95**  
postpaid

Because of the unprecedented demand for these great new products, delivery on orders will take up to 6 weeks.

**HEATH HOTLINE**

To insure the earliest possible delivery, call your order in to the Heath 24 Hour Hotline:

**616-982-3411**



**FREE** The world's largest catalog of electronic kits. Send for your copy today.

HEATH Schlumberger		Heath Company, Dept. 122-13 Benton Harbor, MI 49022	
Please send my FREE Heathkit Catalog.			
NAME _____			
ADDRESS _____			
CITY _____	STATE _____	ZIP _____	
AM324		PRICES & SPECIFICATIONS SUBJECT TO CHANGE WITHOUT NOTICE	

# repair bench

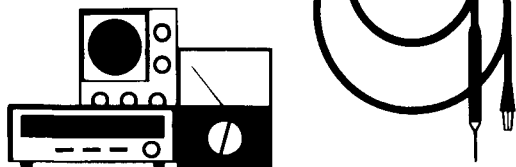

Michael James

## basic troubleshooting

Troubleshooting and equipment repair are two of the toughest problems faced by radio amateurs today. Part of the difficulty is due to the fact that modern ssb equipment is much more complex than the old a-m and CW gear of twenty years ago, but perhaps more important, few amateurs build major pieces of their station equipment anymore so they are probably not as familiar with its circuitry as they should be. When your receiver or transmitter starts giving you trouble, more than likely it will be returned to the factory to be repaired. If the problem isn't too severe, you may avoid using that function which is affected or overlook it altogether. In some cases you may not even be aware of a problem unless another amateur brings it to your attention (distorted speech, poor sideband suppression or splatter, for example).

Although there *may* be some equipment repair problems that are best sorted out by the factory, in most cases you can save yourself a lot of time and money by fixing it yourself. Once you send your gear back to the factory, you may have to wait a month or more until you can get back on the air. In addition, you will probably have to pay the factory ten dollars an hour or more for their technician's time.

Troubleshooting electronic equipment is not difficult, nor does it require a bench full of test equipment. A large selection of test equipment may simplify the task, or allow you to solve a problem more quickly, but 90 per cent of all troubleshooting can be accomplished with a volt-ohmmeter and other simple test equipment you already have on your workbench. In those cases where you need a calibrated signal generator or an oscilloscope, you can often borrow one from your local radio club or from an amateur who lives nearby.

In the coming months this column will be devoted to troubleshooting techniques and how you can use them to fix your own equipment. Although much of the initial discussion will be in general terms that are applicable to practically any electronic equipment, future columns will discuss specific pieces of equipment and unique or unusual circuitry that requires a somewhat different pro-

cedure. If you have solved a particularly difficult equipment problem, we would like to hear about it. There may be others who will be helped by your success.

## basic troubleshooting

There are three basic troubleshooting techniques which can be used to locate and fix circuit malfunctions: signal tracing, resistance measurements and voltage measurements. In receivers and transmitters the problem area is usually located with signal tracing, then pinpointed with resistance and/or voltage measurements. Although some electronic circuits such as gain-control circuits don't lend themselves to signal tracing, the majority of receiver and transmitter circuits can be quickly checked with this method. Once you know how to use signal tracing, in fact, you will probably agree that it's one of the quickest ways to track down a circuit problem.

Basically, signal tracing consists of injecting a signal at the input to a piece of equipment and checking its path through the equipment. If the signal appears at the input to a stage, but not at the output, that stage is the culprit. It may not be the only culprit, but once it's been fixed, you can locate other problem areas along the signal path.

The signal tracer is essentially a very quiet, high-gain audio amplifier with headphone or speaker output. One commercial version which is available at modest cost is shown in the accompanying photograph. If you wish, you can build a simple high-gain audio amplifier around an op amp IC as shown in **fig. 1**, and in a pinch you could even use one channel of your

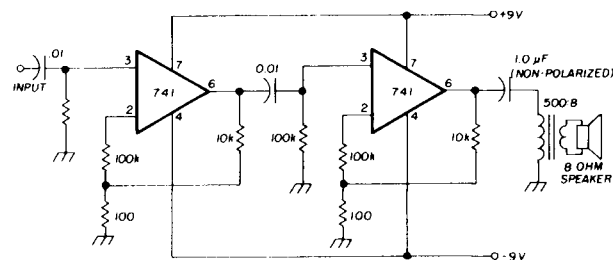

**fig. 1.** Signal tracer circuit which is based on the 741 op amp ICs. Gain is about 80 dB; audio power output is approximately 40 mW, sufficient for most signal tracing.

stereo system. This is all you need if you're working with audio systems, but if you're troubleshooting rf and i-f stages, you will also need a simple demodulator probe such as that shown in **fig. 2**. The one I use is built into a discarded plastic ballpoint pen. You can also use one of the rf probes which are available for vacuum-tube voltmeters.

In addition to the signal tracer (audio amplifier and rf probe) you will also need a signal injector — a device which has a broadband signal output from audio through vhf. There are several pencil-sized signal injectors on the market for less than ten dollars. Most consist of a simple 1 kHz multivibrator which has high harmonic content well above 30 MHz. The circuit in **fig. 3**, which uses



inexpensive high-speed switching transistors, can be used for signal tracing through at least 50 MHz. Built on per-board, this unit is small enough to fit inside the aluminum cases in which expensive cigars are sold (you could also use a plastic pencil holder or toothbrush case).

### signal tracing

Whatever kind of signal tracer you decide to use, you'll want to get the most out of it. Many people who already use signal tracers seem to think that signal tracing is limited to localizing trouble in one section of a receiver or transmitter. However, as will be shown later,

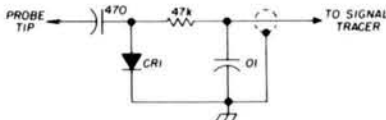

fig. 2. Demodulator rf and i-f probe for signal tracing. Diode CR1 can be practically any signal diode such as 1N34A, 1N60, 1N67A, etc.

the signal tracer can also be used to pin down defective components. All you have to do is know how to use it.

Fast troubleshooting with a signal tracer demands logic, and you'll have to supply that. But even if you haven't done any troubleshooting before, you'll be amazed at how quickly you can track down a faulty circuit with a signal tracer. Fixing the bad circuit after you've located it may be another story, but if you use logic, and the resistance and voltage measurements we will discuss in future columns, you can probably repair any electronic circuit ever built. Things are simplified tremendously if you have a copy of the schematic or the manufacturer's maintenance instructions, but even without these you can, with persistence, be successful.\*

As a starter I'll show you how to use a signal tracer to troubleshoot the sophisticated amateur communications receiver shown in fig. 4. This block diagram is fairly typical of modern superheterodyne receivers although some models may use only one frequency-conversion stage, or may not be equipped with a crystal calibrator or a separate a-m detector. I should also point out that it doesn't make any difference if your receiver uses vacuum tubes, transistors, or some combination of these — the basic signal tracing technique is the same.

First of all, take a look at the schematic and mentally divide it up into blocks representing each stage or function in the set. Fig. 4 has been divided into four basic sections: rf, high i-f, low i-f and audio. In some cases you might want to consider the detectors separately, but they are usually included as part of the last i-f.

First, the rf section. When signal tracing here you'll have to use the demodulator probe. If the receiver is connected to an antenna you will hear a mishmash of incoming signals because most receivers don't have sufficient front-end selectivity to pick out any one signal —

\*Manuals for most amateur equipment manufactured between 1940 and 1965 are available from Hobby Industry, W0JJK, Box H864, Council Bluffs, Iowa 51501. Send self-addressed, stamped envelope for quote.

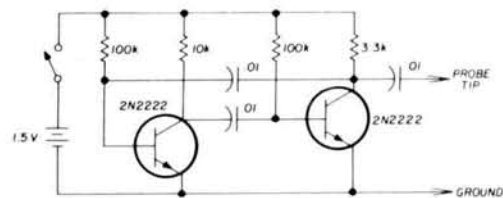
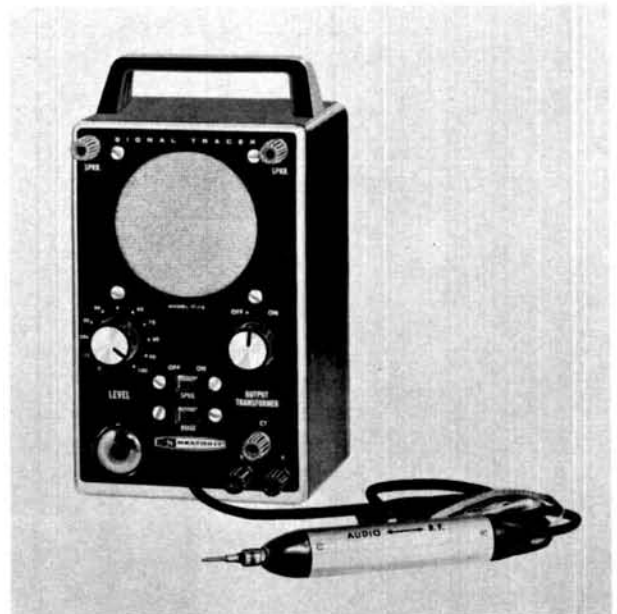

fig. 3. Signal injector is basically 1 kHz multivibrator which has high harmonic output. Circuit shown here has usable output up through 50 MHz. Practically any npn transistors will work in this circuit.

that's done further on, in the low i-f. If all the rf stages are normal, once you set the bandswitch all the signals within several-hundred kHz will be heard through the signal tracer. The collectors of the rf amplifier and mixer transistors (plate circuits in vacuum tube receivers) are the points to check with your probe. If you don't get any signal output from the mixer, something in the rf section is dead.

The high i-f processes the output of the first mixer and consists of a bandpass filter, the second mixer and the variable frequency oscillator. If any of the circuits in the high i-f isn't working properly, the signal picked up by your tracer at the output of the second mixer will reflect it. The low i-f includes the selective filter, i-f amplifier amplification and the detectors. You'll need your demodulator probe for the i-f stages, but the quickest test point for the whole section is after either of the detectors. Here you should hear a clear, undistorted audio signal without the probe. The audio section can also be checked without the probe. If the receiver is okay, you should hear a nice strong signal at the output of the last audio stage.

If the receiver isn't working properly, the quickest



Heathkit IT-12 signal tracer has both visual (eye tube) and audio output. A switchable audio-rf probe is included with the kit, which sells for \$32.95.

way to find the bad circuit is to check signal output about halfway through the set. A good point is the output of the second mixer. If the receiver is connected to an antenna the signal you hear should change as you tune the vfo (since the demodulator probe is an a-m detector, ssb signals will be unintelligible). If your re-

the offending one.

The divide-and-conquer technique of stage isolation works just as well for other symptoms as it does for a radio that is completely dead. You can hunt noise or hum, for example, tracking down the stage where the trouble first appears. It also works for distortion.

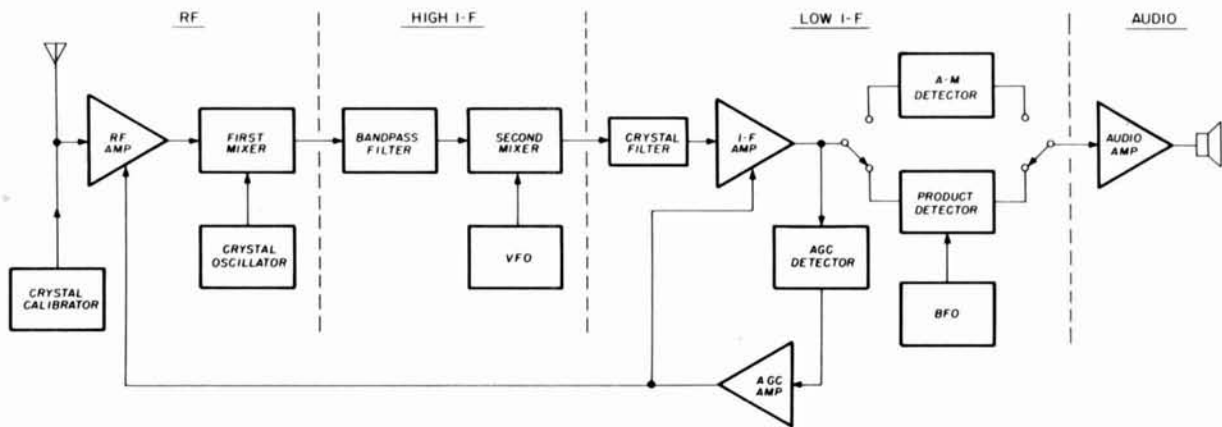

fig. 4. Sectionalizing an amateur communications receiver by functions. Dividing it up this way makes it easy to track down trouble with the signal tracer.

ceiver will tune to one of the WWV channels, this makes an excellent test signal, or you can use your signal injector. The pitch of the wideband injector signal, however, will not change as you tune the vfo.

If the signal is okay at the output of the second mixer, you have cleared the front-end circuits of any suspicion and can proceed to the last half of the set — the output of the low i-f amplifier is a good point. If you don't get an output from the second mixer, the low i-f and audio sections are probably okay.

Assume you get nothing at the output of the second mixer. Divide the front end roughly in half and use the tracer and demodulator again. The output of the first mixer is a good check point. If you have the proper signal there, there's something amiss in the bandpass filter, vfo or second mixer. If there's no signal output from the first mixer, the rf amplifier, crystal oscillator or first mixer stage must be at fault.

The last half of the receiver can be attacked with similar logic. If the signal was okay at the second mixer, the next logical dividing point is the output of the detector, which can be checked directly, without the probe. A signal in the tracer means that everything is okay up to there and the trouble is in the audio section. If you don't get a signal, check the output of the other detector. No signal means it has been blocked between the second mixer and the detector — the crystal filter or one of the i-f amplifiers is the problem.

Note that with only two signal tracer checks you have isolated the problem to one small, functional section of the receiver. If the signal is okay at the input to a stage and not at the output, it's obvious the trouble is between those two points. It's a simple matter to check each of the individual stages within a section to pinpoint

### other checks

If the receiver is suffering from poor sensitivity, the problem can be signal traced by the "straight through" method. If reception is poor, the fastest way to determine which amplifier isn't doing its job is to check the gain of each stage by touching the signal-tracer probe to the input and output; if there is little or no increase in signal strength, the amplifier is weak. Although transistor mixer stages usually have some gain, vacuum tube mixers seldom exhibit gain and may often have a small signal loss, so keep this in mind. The filters introduce loss, too, but you can judge if it's too much after you have a little practice.

There are other little tricks of troubleshooting logic that make it easy to find troubles. If your receiver works alright on a-m but not on ssb or CW, for example, the difficulty is probably with the product detector or bfo —

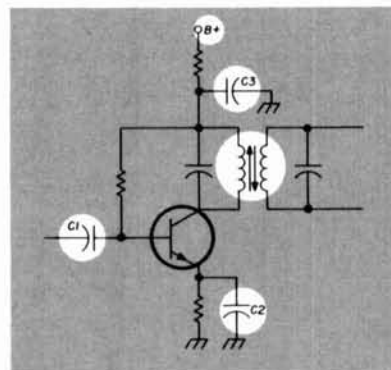

fig. 5. You can check these components with your signal tracer without even unsoldering them from the circuit.

they are the only stages which are not common to a-m. If weak signals sound okay, but strong ones distort, a good suspect is the agc stage which may not be controlling the rf and i-f gain as it should, letting strong signals overload the receiver. Likewise, frequency jumping or drift can usually be traced to the vfo; audio distortion eliminates all but the detector and audio stages; and poor selectivity is usually caused by a bad crystal or mechanical filter.

### getting closer

After they've pinpointed the stage which is causing the problem, many technicians put away their signal tracer and reach for their voltmeter. However, the signal tracer can still tell you things about the circuit you can't find out with a voltmeter. In the amplifier circuit of fig. 5, for example, the highlighted coupling and bypass

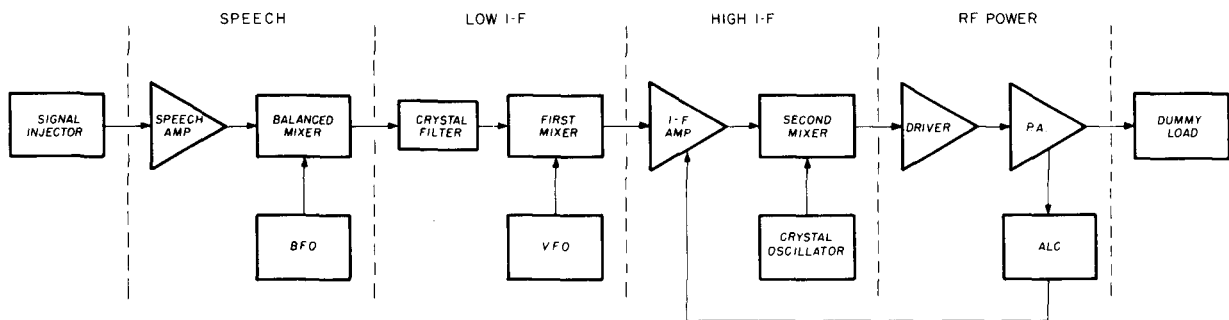

fig. 6. Modern ssb transmitter can be sectionalized by function for troubleshooting purposes.

components can be tested right in the circuit without even unsoldering them.

The coupling capacitor, C1, and the interstage transformer, T1, should pass the signal along with very little attenuation. Whether they are large, as in audio stages, or small, between rf or i-f amplifiers, there should be about the same amount of signal on both sides. If there is any attenuation, it should be small. To check, touch the tracer probe to the input side of the component, then to the output side — if the output is much weaker than the input, the part is defective.

The bypass capacitors, C2 and C3, shunt the signal to ground and their values are chosen to short out practically all the signal at the emitter (C2) and at the power supply end of the interstage transformer (C3). The tracer should hear very little signal at either point. If there's any substantial signal the capacitor isn't doing its job. Even if the transistor is in good health, bad bypass capacitors at C2 or C3 will seriously degrade the gain of the stage.

Sometimes, when checking stage gain or components, you'll find that you don't have sufficient signal strength to determine if a component is doing the job it should. In this case it's helpful to place the signal injection directly at the input to the stage. This will bring the signal level up to the point where you can make meaningful measurements. You can also use the signal injector to quickly move through the receiver to determine which stage is causing the problem. Simply touch the

probe of the signal injector to the input of each stage, starting at the audio output stage, and move back toward the front end, stage by stage. If everything is working properly you will hear the 1 kHz modulation through your receiver's speaker as you inject signal into each stage.

Finally, you can check the B+ line with your signal tracer for any traces of hum. Power supply filter capacitors are like any other bypass capacitors in that they should shunt all signal voltages to ground (power supply ripple in this case) and leave only pure dc. If one of the filter capacitors is weak, you'll hear a considerable amount of hum in the signal tracer. If the dc line isn't properly decoupled you may hear a whistling or hissing sound that is an rf or i-f signal if you could unscramble it. This can usually be traced to a bad bypass (decoupling) capacitor somewhere along the B+ line.

### transmitter signal tracing

A modified form of signal tracing is also suitable for tracking down problems in ssb (and a-m) transmitters. In this case the signal injector is connected to the microphone jack and the transmitter is terminated in a dummy load as shown in fig. 6. Except that the position of the stages is reversed (audio front-end, rf output), the functions of the various stages in a modern ssb transmitter are not that much different than those in a superheterodyne receiver.

By using the signal tracer to track through the stages of the transmitter, you can quickly locate a stage which is blocking the signal (use the demodulator probe for the balanced modulator output and all following stages). The rf output from the final amplifier may be a little too much for the detector diode in the probe so don't connect it directly to the output — placing the probe tip next to the power amplifier compartment should provide enough signal for tracing purposes.

Although the signal tracer won't track down distortion, poor sideband suppression, or vhf parasitics in the transmitter, it's useful for quickly isolating a nonfunctioning stage or component. The signal tracer can also be used to eliminate hum and locate bad decoupling capacitors which are causing unwanted rf feedback. Other transmitter troubleshooting techniques will be discussed in a future column.

ham radio

# Wilson Electronics Corp.

"FACTORY DIRECT ONLY"



## "WILSON GOES MOBILE"

introducing the new WE-224



**\$209<sup>95</sup>**

**SPECIAL INCLUDES:**

**WE-224; 52/52, SIMPLEX PLUS TWO TX/RX CRYSTALS, YOUR CHOICE (Common Repeater Frequency Only), MOUNTING BRACKET; MOBILE MIKE**

### FEATURES

1. 24 Channel Operation
2. One priority Channel
3. Selectable 1 or 10 Watts Out
4. 10.7 Monolithic Filter Installed
5. 455 KHz Ceramic Filter
6. Numerical Read-out on each Channel
7. Built-in Adjustable "Tone- Burst" Generator
8. Front Panel Tone Encoder Control
9. Accepts Wilson 1402 & 1405SM Xtals
10. Individual Trimmer Capacitors for both TX/RX
11. Mosfet Front End
12. Helical Resonator
13. High VSWR Protection Circuit
14. Reverse Polarity Protection Circuit
15. NBFM - 15 KHz Channel Separation
16. External Speaker Jack
17. Built-in Speaker
18. Dynamic Microphone Included
19. Mobile Mounting Bracket Included
20. Frequency Range 144-148
21. 6½"W x 2½"H x 9½"D
22. Weight: 5½ lbs.
23. Power Requirements:  
 Source: 13.5 VDC ± 10%  
 Receive: .45A  
 Transmit: 2.6A (10W), .7A (1W)

**1402SM HAND HELD  
2.5 WATT  
TRANSCIVER  
144-148 MHz**

**\$199.95**



OPTIONAL TOUCH-TONE PAD SHOWN

### FEATURES

#### 1402 SM

- 6 Channel Operation
- Individual Trimmers on all TX/RX Crystals
- All Crystals Plug In.
- 12 KHz Ceramic Filter
- 10.7 IF and 455 KC IF
- .3 Microvolt Sensitivity for 20 dB Quieting
- Weight: 1 lb. 14 oz. less Battery
- 5-Meter/Battery Indicator
- Size: 8 7/8 x 1 7/8 x 2 7/8
- 2.5 Watts Minimum Output @ 12 VDC
- Current Drain RX 14 MA TX 500 MA
- Microswitch Mike Button

#### 1405 SM

- 6 Channel Operation
- Individual Trimmers on all TX/RX Crystals
- All Crystals Plug In
- 12 KHz Ceramic Filter
- 10.7 and 455 KC IF
- .3 Microvolt Sensitivity for 20 dB Quieting
- Weight: 1 lb. 14 oz. less Battery
- Battery Indicator
- Size: 8 7/8 x 1 3/4 x 2 7/8
- Switchable 1 & 5 Watts Minimum Output @ 12 VDC
- Current Drain: RX 14 MA TX 400 MA (lw) 900 MA (5W)
- Microswitch Mike Button
- Unbreakable Lexan® Case

**1405SM HAND HELD  
5 WATT  
TRANSCIVER  
144-148 MHz**

**\$279.95**



#### SPECIAL ON EACH RADIO INCLUDES:

1. Antenna
2. Case
3. Batteries
4. 52/52 Xtal
5. Your Choice of 2 TX/RX Crystals (Common Frequency Only)



### HAND HELD ACCESSORY SPECIALS

DESCRIPTION	SPECIAL PRICE
BC1 - BATTERY CHARGER	\$36.95
BP - NI-CAD BATTERY PACK	15.00
LC1 - 1402 LEATHER CASE	14.00
LC2 - LEATHER CASE FOR 1405, 2202, 4502	14.00
SM2 - SPEAKER MIKE FOR 1402 AND 1405	29.95
TE1 - SUB-AUDIBLE TONE ENCODER INSTALLED	39.95
TTP - TOUCH TONE PAD INSTALLED	\$59.95
XF1 - 10.7 MONOLITHIC IF XTAL FILTER INST.	\$10.00
CRYSTALS: TX OR RX (Common Freq. Only)	4.50



**BC-1 NI-CAD BATTERY CHARGER WITH REGULAR AND TRICKLE CHARGE FEATURE**

# Wilson Electronics Corp.

announces the addition of

## 220 AND 450

### 2202 SM

FREQUENCY RANGE 222 - 225 MHz

- 6 Channel Operation
- Individual Trimmers on all TX/RX Crystals
- All Crystals Plug In
- 12 KHz Ceramic Filter
- 10.7 and 455 KC IF
- .3 Microvolt Sensitivity for 20 Db Quieting
- Weight: 1 lb. 14 oz. less Battery
- Battery Indicator
- Size: 8 7/8 x 1 3/4 x 2 7/8
- Switchable 1 & 2.5 Watts Output @ 12 VDC
- 2.5 Watts Minimum Output @ 12 VDC
- Current Drain: RX 14 MA TX 500 MA
- Microswitch Mike Button
- Unbreakable Lexan® Case

USES SAME ACCESSORIES AS 1405

INTRODUCTION SPECIAL

## \$279<sup>95</sup>

#### INCLUDES

1. 2202 SM
2. Antenna
3. Battery Pack
4. Leather Case
5. 223.00 Simplex Installed



### 4502 SM

FREQUENCY RANGE 442 - 450 MHz

- 6 Channel Operation
- Individual Trimmers on all TX/RX Crystals
- All Crystals Plug In
- 12 KHz Ceramic Filter
- 10.7 and 455 KC IF
- .3 Microvolt Sensitivity for 20 Db Quieting
- Weight: 1 lb. 14 oz. less Battery
- Battery Indicator
- Size: 8 7/8 x 1 3/4 x 2 7/8
- Switchable 1 & 1.8 Watts Output @ 12 VDC
- Current Drain: RX 14 MA TX 500 MA
- Microswitch Mike Button
- Unbreakable Lexan® Case

USES SAME ACCESSORIES AS 1405

INTRODUCTION SPECIAL

## \$299<sup>95</sup>

#### INCLUDES

1. 4502SM
2. Antenna
3. Battery Pack
4. Leather Case
5. 446.00 Simplex Installed

TO: WILSON ELECTRONICS CORP., 4288 S. POLARIS AVE., LAS VEGAS, NEVADA 89103  
(702) 739-1931

## JANUARY FACTORY DIRECT SALE ORDER BLANK

\_\_\_\_\_ 2202 SM @ \$279.95. \_\_\_\_\_ 4502 SM @ \$299.95. \_\_\_\_\_ WE-224 @ \$209.95.  
\_\_\_\_\_ 1402 SM @ \$199.95. \_\_\_\_\_ 1405 SM @ \$279.95. \_\_\_\_\_  
\_\_\_\_\_ BC1 @ \$36.95. \_\_\_\_\_ BP @ \$15.00. \_\_\_\_\_ LC1 @ \$14.00. \_\_\_\_\_ LC2 @ \$14.00.  
\_\_\_\_\_ SM2 @ \$29.95. \_\_\_\_\_ TE1 @ \$39.95. (SPECIFY FREQUENCY \_\_\_\_\_)  
\_\_\_\_\_ TTP @ \$59.95. \_\_\_\_\_ XF1 @ \$10.00. \_\_\_\_\_ TX XTALS @ \$4.50 ea. \_\_\_\_\_ RX XTALS @ \$4.50 ea.

EQUIP TRANSCIVER AS FOLLOWS: XTALS A. \_\_\_\_\_ B. \_\_\_\_\_  
C. \_\_\_\_\_ D. \_\_\_\_\_ E. \_\_\_\_\_ F. \_\_\_\_\_

ENCLOSED IS \_\_\_\_\_  CHECK  MONEY ORDER  MC  BAC

CARD # \_\_\_\_\_ EXPIRATION DATE \_\_\_\_\_

NAME \_\_\_\_\_

ADDRESS \_\_\_\_\_

CITY \_\_\_\_\_ STATE \_\_\_\_\_ ZIP \_\_\_\_\_

SIGNATURE \_\_\_\_\_

Add \$5.00 per Radio for Shipping, Handling; and Crystal Netting.

SALE VALID JANUARY 1 THRU 31, 1976

HR

NEVADA RESIDENTS ADD SALES TAX

# RAM keyer update

## Circuit improvements for the random access memory electronic keyer described in a previous issue

This is a followup report on the two-RAM programmable keyer article in the October, 1973, issue of *ham radio*<sup>1</sup> and my correction note<sup>2</sup> in the December, 1974, issue. Many inquiries have been received concerning possible parts procurement and solutions for faulty keying. This article will enable you to build this keyer with a minimum of frustration.

### printed-circuit board

The majority of inquiries were about the procurement of the printed-circuit board. As indicated in the original article, the board, as well as the kit of parts for the keyer, could be obtained from the indicated address. It now appears that this company is no longer the source for the parts or the printed-circuit board. If you have a lot of time and patience the circuit can be hand wired. In fig. 4 a full sized view of the etched board, from the foil side, is shown for those who would like to build one. The layout of the components and external connections are shown in fig. 5. This board diagram is free from the errors of the original version and incorporates the circuit change as described in reference 2.

### clock circuit

Clock pulses are derived from a NE555 timer connected for astable operation; i.e., as a free-running multivibrator. Using the values of the original article, the maximum theoretical keyer speed will be about 17 wpm.

Redesign of the keyer for higher speeds is easily accomplished by noting fig. 1. The IC manufacturer gives the clock frequency in terms of  $R_A$ ,  $R_B$ , and  $C$  as:

$$f(\text{Hz}) = \frac{1.44}{(R_A + 2R_B)C}$$

where  $R_A = 1\text{k ohm}$ ,  $R_B = 6.8\text{k to }56.8\text{k ohms}$  and  $C = 6.8 \mu\text{F}$ . Converting the clock frequency to keying speed,<sup>3</sup>

$$\text{Speed (wpm)} = 1.2f$$

$$\text{Speed (wpm)} = \frac{1.73}{(R_A + 2R_B)C}$$

so that the speed range is expected to be from 2.2 to 17.4 wpm. Fig. 2 shows the values of  $C$  and  $(R_A + 2R_B)$  for the desired speeds. Using  $C = 6.8 \mu\text{F}$  the graph shows that the speed varies when the resistance changes from 14.6k to 114.6k ohms. In my case, a 3.3k resistor was used in place of the 6.8k, and a 5  $\mu\text{F}$  capacitor was used. Maximum keying speed was then 32 wpm, and a slight reduction in the duty cycle of the clock pulses (8%) occurred, which didn't affect the keyer performance. The 50k pot should have a log rather than a linear taper to permit a linear speed range; otherwise the higher keying speeds will crowd together near the upper portion of the pot rotation.

### random-access memories

The second largest number of inquiries was about the RAM devices. The (Signetics) 25L01B is the low-power dissipation, pin-for-pin equivalent of the popular 1101 256-bit RAM (National Semiconductor and others). I first used the 25L01B\* without any problems. If its price is a little too high for you, you can try the 1101 version as advertised by large discount houses in the amateur literature (about \$2.50 each). My experience has been that you get what you pay for. I bought a half dozen of these bargain specials and only one worked correctly. If you expect a cheap bargain, you'll probably get a cheap device. *Caveat emptor*.

### faulty keying

Even after incorporating the changes in the correction note,<sup>2</sup> some readers still had problems with sending code

\*Obtained from Schweber Electronics, 5640 Fisher Lane, Rockville, Maryland 20852 at \$6.50 each.

By Howard M. Berlin, K3NEZ, 2 Colony Boulevard, Apt. 123, Wilmington, Delaware 19802

characters. This annoying problem arises from stray rf and spikes generated from the TTL logic. In his article on the Accu-Keyer,<sup>4</sup> WB4VVF discusses some possible cures. It is *essential* that all external leads be shielded from rf. Use RG-174/U or similar coax from the keyer output to the transmitter. If an external paddle is used, use shielded three-wire cable from the paddle to the keyer. As a further precaution, add 0.1  $\mu\text{F}$  bypass capacitors on the three inputs of the paddle at the input jack. TTL spikes can usually be eliminated by adding 0.01  $\mu\text{F}$  capacitors from each IC chip's +5 volt pin to ground. In more stubborn cases it may be necessary to place a number of 0.01 to 0.1  $\mu\text{F}$  capacitors around the edge of the printed circuit board (ground) to +5 volt points. I used about eight additional capacitors and have the keyer right next to my kilowatt linear without any trouble in keying.

Another tip on bypassing to cure faulty keying was received from Ken Beck, K3DW. He found that false

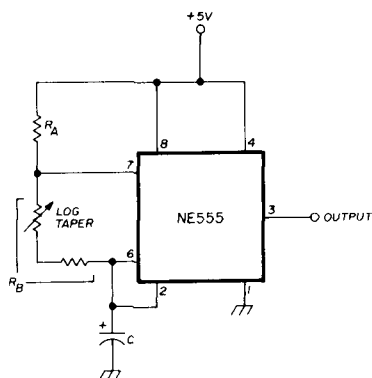

fig. 1. NE555 timer IC connected for astable operation.

dash generation occurred due to transient triggering of the master flip-flop in the 7473 IC. To eliminate the transients requires the addition of a disc capacitor bypass (0.02 to 0.05  $\mu\text{F}$ ) directly between pins 4 and 11 of this 7473. Similar bypassing of the 7473 that controls the address cycle also helps to prevent unwanted cycle starts caused by transients. Also disc capacitors (0.02  $\mu\text{F}$ ) connected from each key lead to chassis (installed right at the key jack) helped to reduce false triggering. In any case, bypassing is necessary to eliminate keying transients.

Another possible cause of faulty keying is in the clock circuit. As mentioned before, the clock is free-running and will continue to run until power is disconnected. Faulty keying *may* occur if the pulses of the individual Morse code characters are not in synchronization with the rest of the logic. The only way to cure this is to redesign the clock to run only when the desired characters are being sent.

### momentary clear switch

A useful addition to this keyer circuit, offered by K3DW, is a momentary switch to clear the memory during either read or write operation, fig. 3. The 6.8- $\mu\text{F}$  timing capacitor for the NE555 clock IC is grounded

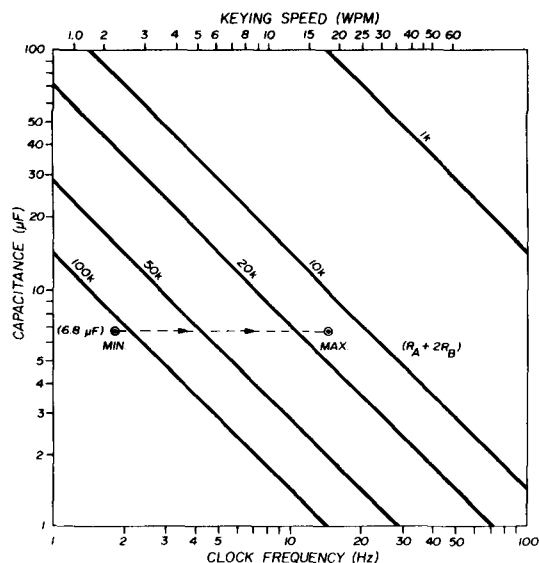

fig. 2. Capacitance, C, and resistance, ( $R_A + R_B$ ), required to obtain desired keying speeds.

through a normally closed switch, which is bypassed by a 0.01  $\mu\text{F}$  capacitor. When the clear switch is depressed, a 0.1  $\mu\text{F}$  capacitor discharges into the reset input of the 7473 that controls the address cycle. This ensures that not only will the remainder of the address cycle during which the switch was operated be cleared, but that a new cycle will be started and cleared. In the write mode, complete memory erasure is provided.

### transmitter keying and sidetone

A relay output to key the transmitter can be used to replace the 2N4888 keying transistor shown in the original circuit (see fig. 6). The 5-volt reed relay, which is similar to that provided by Electronics Applications Company part no. 1A5AH,\* provides excellent keying even at speeds above 35 wpm.

An improved keying monitor to replace the 7413 NAND Schmitt trigger<sup>5</sup> is also shown in fig. 6. This

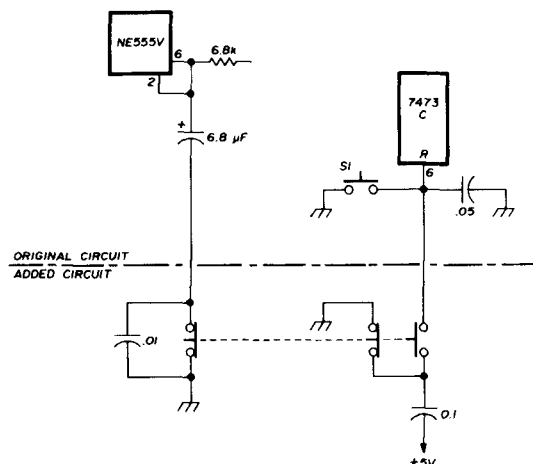

fig. 3. Addition of clear switch to clear keyer memory during read or write mode (contributed by K3DW).

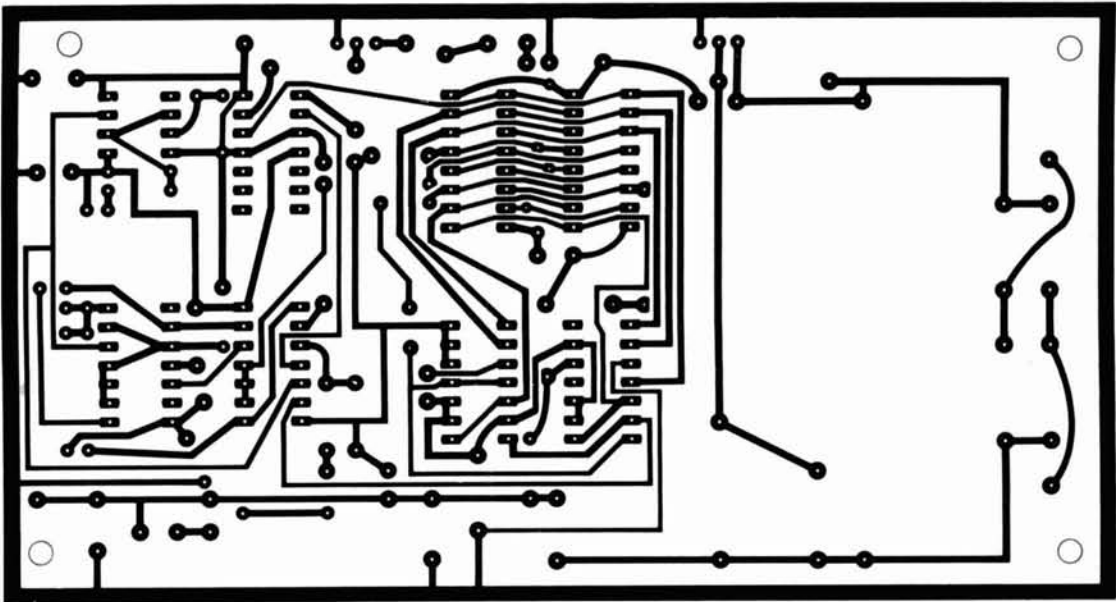

fig. 4. Full-size etched circuit board layout. Component placement is shown in fig. 5.

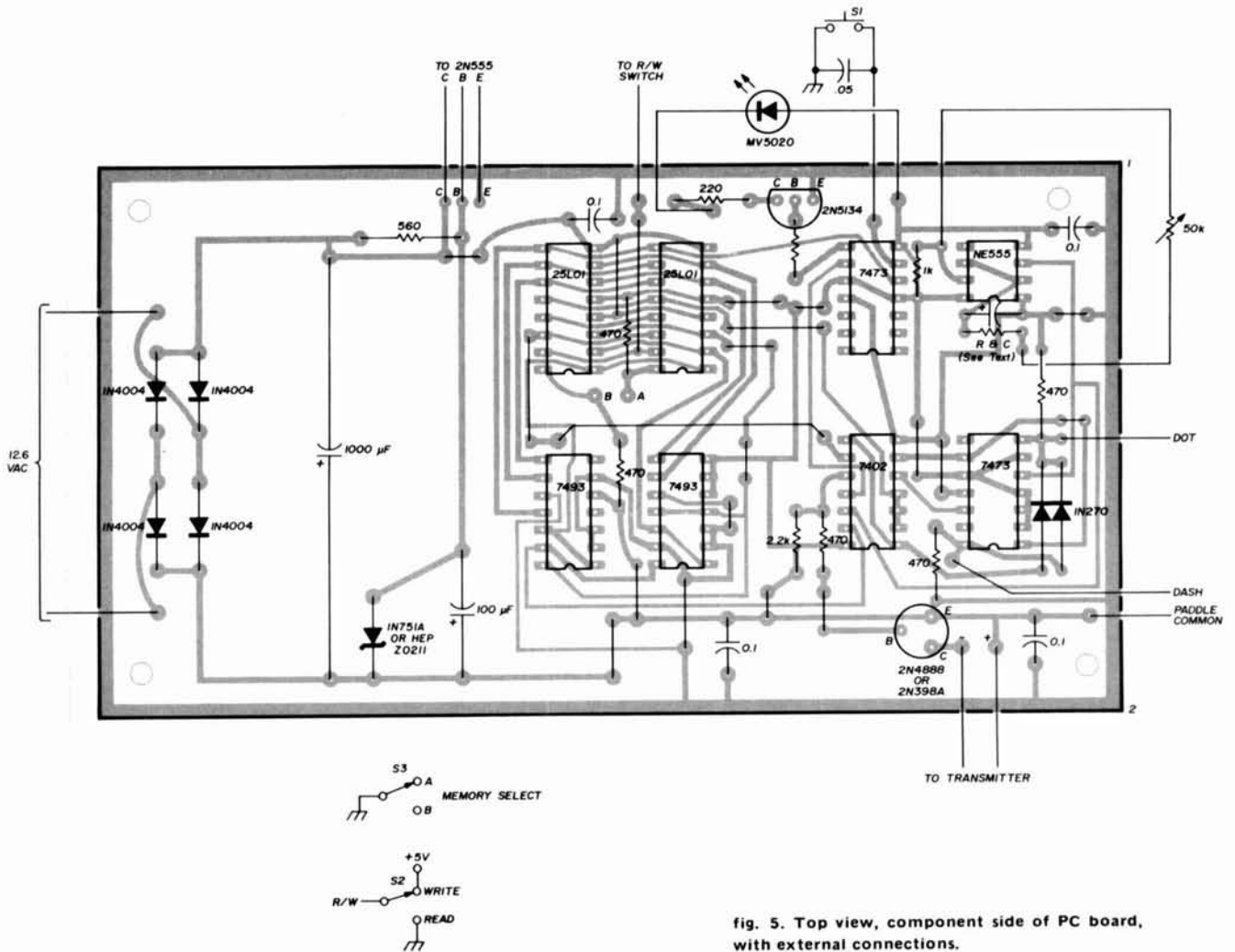

fig. 5. Top view, component side of PC board, with external connections.



circuit uses a NE555 wired as an astable multivibrator similar to a circuit used by WA5TRS.<sup>6</sup> If you don't want the added expense of the 500k pot, a resistor of about 150k ohms should provide a pitch pleasing to the ear, with the components shown.

#### construction notes

The printed-circuit board must be insulated from the metal cabinet by short standoff insulators. Also, if the keying paddle input jack is not insulated from the chassis, the PC board must be insulated from the cabinet. If you ground the board, insulate the input jack. In either case the keyer output jack should be insulated.

#### summary

All the troubleshooting concepts mentioned resulted from approximately 170 manhours debugging this keyer *after* it was assembled. Troubleshooting was done with a four-channel storage oscilloscope and a lot of patience.

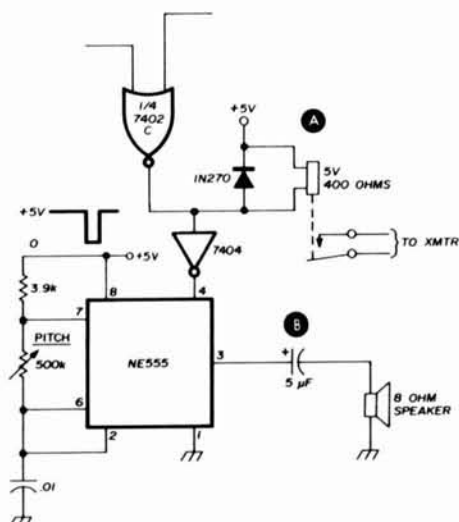

fig. 6. Alternative method for keying transmitter using a reed switch, (A). A simple keying monitor is shown in (B).

If you don't have access to this equipment, this article will be of use to you. You might want to include the additional memories described in reference 5.

\*Electronics Applications Co., 2213 Edwards Avenue, South El Monte, California 91733.

#### references

1. Michael Gordon, WB9FHC, "Electronic Keyer with Random-Access Memory," *ham radio*, October, 1973, page 6.
2. Howard M. Berlin, K3NEZ, "Memory Keyer," (Comments), *ham radio*, December, 1974, page 58.
3. *The ARRL Radio Amateur's Handbook*, ARRL, Newington, Connecticut, 1973 Edition, page 356.
4. James M. Garrett, WB4VVF, "The WB4VVF Accu-Keyer," *QST*, August, 1973, page 19.
5. Howard M. Berlin, K3NEZ, "Increased Flexibility for the Memory Keyer," *ham radio*, March, 1975, page 64.
6. Joe Buswell, WA5TRS, "Simple Integrated-Circuit Electronic Keyers," *ham radio*, March, 1973, page 38.

ham radio

# STRICTLY FOR PERFORMANCE

## RINGO RANGER

### BASE STATION HAM ANTENNA

4.5\* - 6.0\*\* dB GAIN

ARX-2, 137-160 MHz  
ARX-220, 220-225 MHz  
ARX-450, 435-450 MHz

\* Reference 1/2 wave dipole.  
\*\* Reference 1/4 wave whip used as gain standard by many manufacturers.

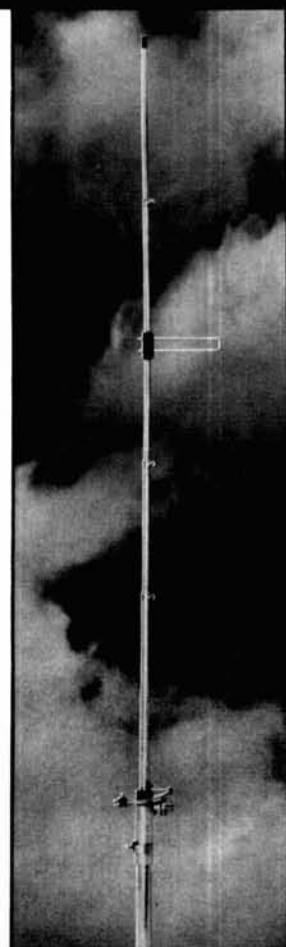

... designed by professionals to professional standards!

... smart in looks, practical in design, light in weight, exclusive in matching and phasing system, the ultimate in "capture area" ... we call RINGO RANGER, "Mr. Pro!" This offers hams a superior omni-directional base station antenna with a very low angle of radiation for higher gain and extended coverage. Easily mast or tower mounted. In stock worldwide with your distributor.

 **cushcraft**  
CORPORATION  
621 HAYWARD ST., MANCHESTER, N.H. 03103

# CIRCUITS & TECHNIQUES

Ed Noll  
W3FQJ

## audio-power integrated circuits

Audio-power ICs are available in the 5-watt and higher ranges for many applications. Some include an integrally designed heatsink as part of the package (fig. 1). These devices are convenient for making inboard or outboard amplifiers when you need some additional audio punch. Most will drive 8- and 16-ohm speakers. For QRP work they can be used as a complete speech amplifier/demodulator for a-m, ssb, and fm. A modulation transformer can be added to match their low-impedance output to the transmitter. At the QRPP level, these ICs can be used as a single-module class-AB or class-B a-m modulator.

The RCA CA3131 and CA3132 (fig. 2) are two audio-power ICs that include preamps, power amplifier, and integral heatsink. The CA3131 has an internal feedback network that maintains an overall gain of approximately 48 dB. The CA3132 has no feedback network but has facilities for connecting one externally, depending on specific application. In this case the external feedback network usually connects between terminals 6 and 16. The package is a 16-pin dual-inline with the four center pins removed.

fig. 1. Sinclair IC-12 audio power IC provides up to 6 watts power output into an 8-ohm load. Voltage gain is about 250; input impedance is 250k.

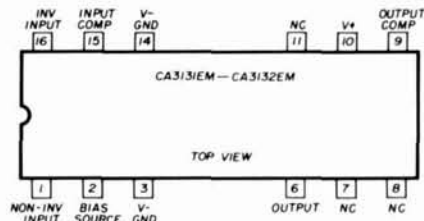
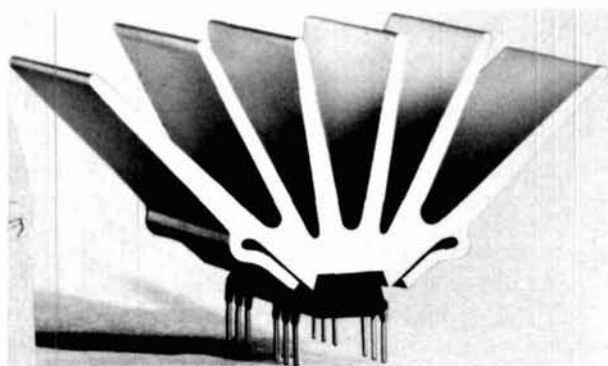

fig. 2. Pin-out diagram of the RCA CA3131 and CA3132 audio power ICs. The CA3131 has an internal feedback network that maintains overall gain at about 48 dB. The CA3132 has no internal feedback but one can be connected externally (see text).

Power output is 4 watts minimum and is typically 5 watts. Recommended supply voltage is 24 volts dc. The load can be either 8 or 16 ohms, with 8 ohms providing higher output. Zero-signal supply current is only 10 mA — certainly a favorable attribute for solar- and battery-power applications. Inverting and noninverting inputs are included. Output is single-ended; minimum input impedance is 200k but typically 1 megohm.

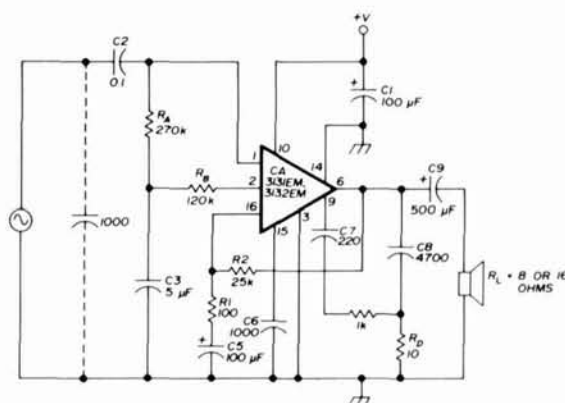

fig. 3. Five-watt audio power amplifier based on the RCA CA3131/3132. The 1000 pF capacitor marked with an asterisk is required if the input has an open circuit.

A complete schematic including external components is shown in fig. 3. The audio signal is applied to the noninverting input, terminal 1, through C2. Input biasing is by  $R_A$  and  $R_B$ .  $R_B$  and C3 filter any ac ripple from the supply voltage line. As mentioned, the input impedance is high; therefore in a practical circuit the input impedance is largely set by the ohmic value of  $R_A$ .

Filter capacitor C1, an electrolytic, should be placed as near as possible to terminal 10. C6 sets a 46 dB closed-loop gain point at 200 kHz. C7 ensures equal gain characteristics on positive and negative signal swings. C9 sets the amplifier low-frequency response.

$R_1$  and  $R_2$  are a part of the feedback network and need only be inserted when the CA3132 is used. C8 compensates for speaker inductance, with  $R_D$  limiting any current surge. Closed-loop gain equals the ratio  $(R_1 + R_2)/R_1$ . The low-frequency 3-dB-down point occurs when C5 reactance equals the ohmic value of  $R_1$ .

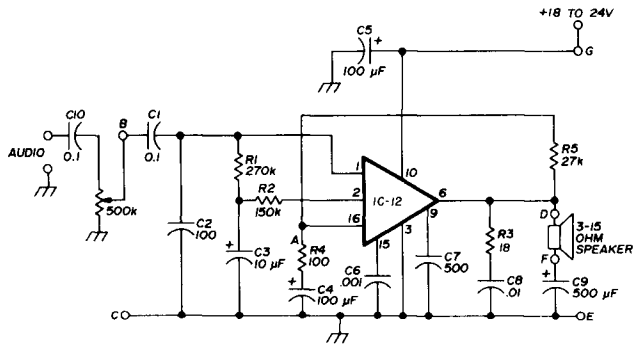

fig. 4. Five-watt audio power amplifier featuring the Sinclair IC-12 audio power IC. Zero-signal supply current is a low 10 mA.

The British Sinclair IC-12\* (fig. 1) has a power output up to 6 watts with a 30 mV input when its output is connected to an 8-ohm load. Permissible output load impedance is 3 to 15 ohms. Voltage gain is approximately 250; input impedance, 250k. Zero-signal supply current is a low 10 mA. I've used the circuit of fig. 4 successfully for many receiver and modulator applications. Again, a modulation transformer can be substituted for the speaker if the modulated system reflects a 3 to 15 ohm impedance.

One of the more unusual applications of the IC-12 was in a broadcast-band receiver (fig. 5) using a phase-locked loop (PLL) detector. The PLL output was connected directly to the IC-12 audio-input terminals (fig. 4). Good performance and acceptable selectivity were obtained.

External parts values can be selected according to desired performance. For example, C1 (fig. 4) can be used to control bass rolloff. The 3-dB-down point is located approximately at the frequency at which C1

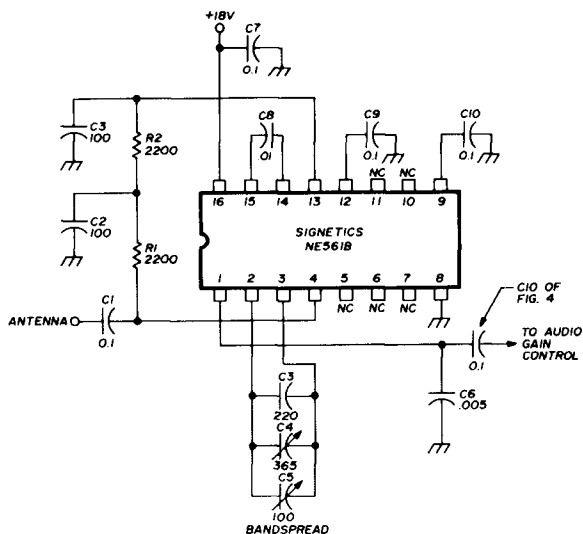

fig. 5. Phase-locked loop a-m detector which uses the Signetics NE561B. In a commercial broadcast-band receiver this detector was used with the IC audio power amplifier of fig. 4.

reactance equals the ohmic value of R1. C2 is needed only if the input signal source is from a very high impedance. C3 ensures good power-supply ripple rejection and low-frequency stability. Low-frequency rolloff is also influenced by R4 and C4. Rolloff frequency is that frequency at which reactance equals resistance. C5 is the power supply filter. High-frequency performance is influenced by C6 and C7, with C7 having its greater influence on the negative-swinging excursions. The value shown for C6 ensures low distortion up to 50 kHz. As in the previous schematic, fig. 3, C8 and R3 compensate for loudspeaker inductance, while C9 can be used to limit the bass response. R4 and R5 set the voltage gain:

$$V_G = \frac{R4 + R5}{R4}$$

The value of R5 can be increased to bring up the gain. For example, with a value of 470, the gain is 5000. In this case the input signal need only be 1 millivolt to produce rated output, but distortion is higher and careful layout is important to minimize stray feedback.

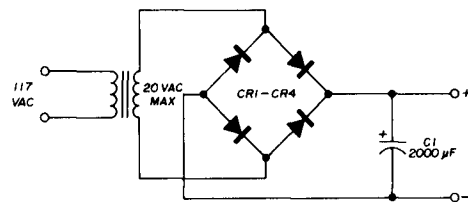

fig. 6. Suggested power supply. The diodes should be rated at 30 PIV, 1 amp. Transformer secondary voltage above 20 volts ac is not recommended.

However, if only a limited increase in gain is desired, the ohmic value of R5 can be increased gradually to meet specific needs and perhaps need not be increased to the point at which instability becomes a problem. If battery operation is not desired, a simple power supply can be built around a filament transformer as in fig. 6. Use a solid-state bridge rectifier, with each diode having a rating of at least 1 ampere and 30 volts PIV. A secondary voltage above 20 volts ac is not recommended.

### multimode detector

The Plessey SL624C IC can be used to detect a-m, fm, ssb or CW signals. In ssb and CW reception it functions as a product detector with built-in oscillator. Operation as a quadrature detector recovers fm while a-m signals are demodulated with a synchronous detector. As an a-m detector, the SL624C is capable of rejecting broadband i-f noise as compared to a conventional envelope detector. The SL624C has been designed specifically for use in mobile, hf, and vhf transceivers. With a suitable circuit arrangement it can also be used to demodulate fm broadcast or TV audio signals.

The SL624C IC is shown in fig. 7. At left is an audio amplifier with input at pin 1 and outputs at pins 15 and

\*Available from Audionics, 8600 NE Sandy Boulevard, Portland, Oregon 97220.

16. This amplifier has a gain of 12 dB. Included also is a limiting amplifier with input at pins 3 and 4 and output at pins 6 and 7. This amplifier operates up to 30 MHz and starts limiting with a 100-mV input level. Loop gain is about 70 dB. The limiting amplifier can be operated as

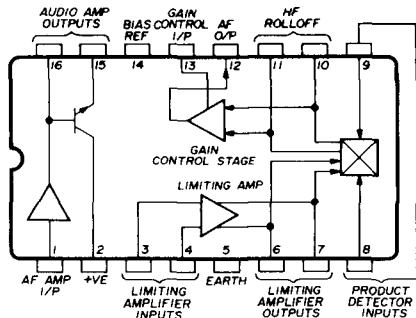

fig. 7. Plessey SL624C multimode detector can be used to detect a-m, fm, ssb or CW signals. Practical detector circuits using this IC are shown in fig. 8.

a beat-frequency oscillator as in the demodulation of an ssb signal.

The detector is a double-balanced modulator (like the Plessey SL640C). The limiting amplifier output is applied to the detector. The detector output connects to the audio gain control stage input. This gain can be regu-

operated as a crystal oscillator. Its output is applied to the detector. Note the external crystal and the connection to pins 6 and 7. The sideband signal to be demodulated is applied through a coupling capacitor to pin 8. After passing through the gain control stage, the recovered audio is removed at pin 12 and applied through the 0.1  $\mu$ F capacitor to the audio amplifier input through pin 1. Audio can be taken at either pin 15 or 16. The signal input requirement is 50 mV maximum, but good performance at a lower audio level can be obtained with an input as low as 5 mV.

In the synchronous detection of an a-m signal, input is applied to the detector through pin 8. Signal is also applied into the limiting amplifier through pin 3. In the limiting amplifier, the carrier is separated from the modulation and is used to generate a demodulating carrier component, which is applied to the detector and used to demodulate the incoming a-m signal. Adequate signal must be applied to permit limiting during modulation troughs to avoid distortion. The input signal should be 5 to 50 mV. An external agc system is recommended for this detection mode.

In fm detection, the signal is applied to the limiting amplifier input at pin 3, then through a phase-shift network to the detector input. Also the quadrature component is applied to the detector input through pins 8 and 9. Note the resonant circuit C1-L1. The detector output is proportional to the relative phase of the two inputs, with the quadrature component (which does not devi-

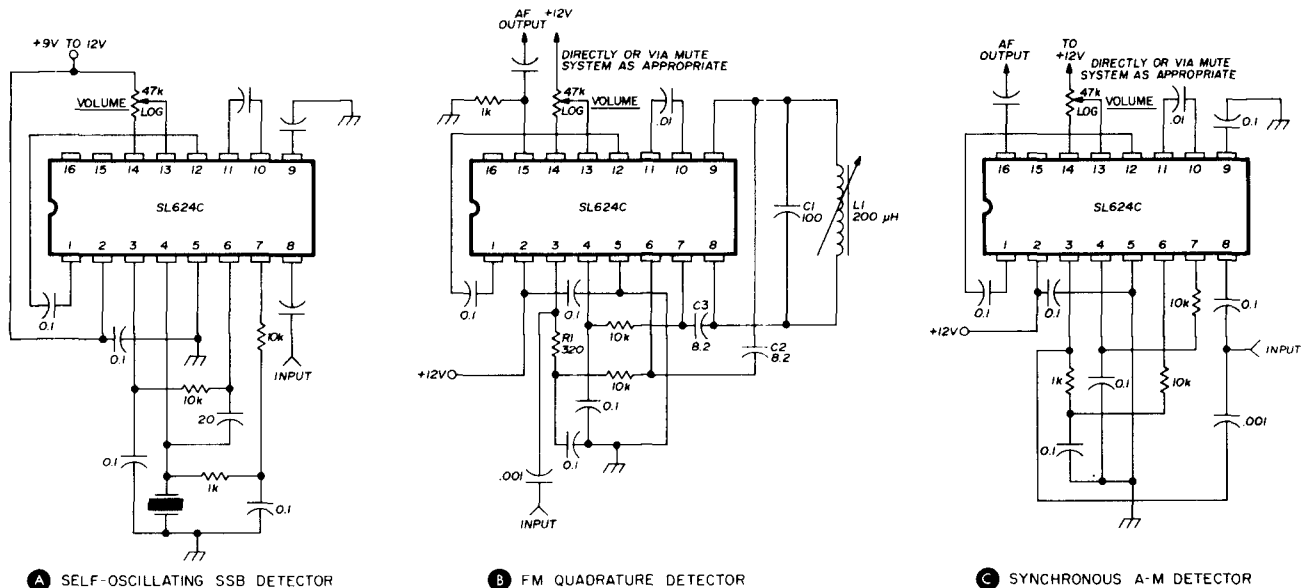

fig. 8. Practical detector circuits using the Plessey 624C include a self-oscillating ssb detector (A), fm quadrature detector (B), and synchronous a-m detector (C).

lated with a control voltage at pin 13. Audio output is removed from the gain stage and made available at pin 12. If desired, the output can be muted by connecting pin 13 to ground with a switch or electronically with a squelch circuit.

Practical detector circuits are given in fig. 8. In the sideband demodulation mode, the limiting amplifier is

ate) serving as a reference phase. The recommended input signal should be at least 200  $\mu$ V, although demodulation occurs with an input signal as low as 100  $\mu$ V. The only adjustment required is that of the phase-shift circuit. An external squelch circuit is used to reduce high-level noise when no signal is being received.

ham radio

# Tone Encoding - Decoding at its BEST

## DATA TONE ENCODERS

### SOLID STATE CRYSTAL CONTROL TONE DECODERS

- 12 or 16 Data Tone digits
- Ideal for hand held units
- Choice of 4 keyboard styles
- RF proof
- Temperature, -20° to 150°F
- CMOS IC Encoder
- Bell System Compatibility
- Easy Installation
- Sub-miniature size
- Crystal Controlled
- Single Tone capability
- Low cost



Style A



Style B



Style C



Style D

### SELF-CONTAINED KEYBOARD ENCODERS

Complete 12 or 16 digit Data Tone keyboard encoders for mounting directly to side of hand held transceivers. All electronics included WITHIN keyboard, nothing to add inside of transceiver. Only 1/4" thick. Ready for easy installation, just add three connections to unit. RF proof. Select keyboard style when ordering.

DTM ..... \$49.50

### SUB-MINIATURE DATA TONE ENCODER AND KEYBOARD

Data Tone encoder for mounting INSIDE hand-held transceiver, keyboard mounts on side of transceiver. P.C. board only 0.8" x 1.2". RF proofed. Assembled and ready for easy installation. Select keyboard style when ordering.

SME ..... \$29.50

### DO IT YOURSELF ENCODERS

Now, buy all the major parts — "ala-carte" and build your own Data Tone Encoder. All you need is a Keyboard, Digital Data Tone Encoder, a 1-MHz crystal, and P.C. board. Parts come with complete set of application notes, schematics and instructions.

Keyboard, your choice of keyboard style ..... \$8.50

Digital D. T. Encoder with 1-MHz HC-6 Crystal ..... \$12.50

Digital D. T. Encoder with 1-MHz Slim HC-6 Crystal ..... \$13.50

P.C. board 0.8" x 1.2" ..... \$2.50

All resistors, capacitors, and P.C. board ..... FREE

(With purchase of keyboard, encoder and crystal)

### AUTOMATIC DATA TONE DIALER

Automatic mobile telephone dialing is now available. By the push of a single button you can automatically dial up to six separate 7-digit numbers. All solid-state micro-power COS-MOS design. Automatic PTT operation. Programmable to send telephone number only, access code plus telephone number or telephone number plus an identification number. Low profile dash mount, easy installation. Compatible with most radio equipment. Available with keyboard for manual dialing of numbers. Manual operation provides automatic PTT operation with 1 1/2 second transmitter hold.

AD-6 Without keyboard 99.50

AMD-6 With keyboard 119.50

Factory programming of numbers \$7.50.



### DATA TONE PADS

Standard size 12 and 16 digit Data Tone Pads. Automatic PTT operation with 1 1/2 second transmitter hold. Self powered via internal 9V battery. Audio and PTT outputs, TTP-1 and TTP-2 also has low volume audio monitor for acoustically coupling of tones to microphone. Zero quiescent current. Operating temperature -20°F to +150°F. R. F. proof.

TTP-1 16 digit 3" x 5 1/2" x 1 1/2". Sh. Wt. 2 lbs. 79.50

TTP-2 12 digit 3" x 5 1/2" x 1 1/2". Sh. Wt. 2 lbs. 59.50

### DATA TONE TO DIAL PULSE CONVERTER

Convert standard 0-9 Data Tone digits to Bell System compatible dial pulse code. Completely solid state. Includes state-of-the-art Phased Locked Loop anti-falsing Data Tone decoder, large capacity 64-digit memory and solid state pulsing. Starts dialing on first incoming digit. Memory will not become congested due to rapid succession of incoming digits. Cancel and redial function. \* and # digits are decoded and provided for remote control purposes. Available as p.c. board or rack mounting.

DPC-121 P.C. Board \$195.00

DPC-121R Rack Mount \$285.00

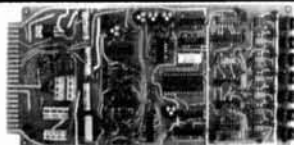

### ANTI-FALSING DATA TONE DECODER

Now, a true anti-falsing decoder/receiver. Virtually immune to high noise or audio falsing. Twelve or 16 digit capability. Completely solid state, uses latest Phased Locked Loop decoding. Single 5-volt power supply. Heavy duty transistor output. Available as p.c. board or 19" rack.

TTD-126-12 12 digit P.C. \$149.95 Rack \$219.95

TTD-126-16 16 digit P.C. \$169.95 Rack \$239.95



### REPEATER AUTO PATCH

It's complete — a single digit access/disconnect Auto Patch facility. All you need is a repeater and the phone line. Complete with automatic disconnect, dialing capability, two way audio monitor plus remote control. When used with a rotary dial exchange, Data Signal's DPC-121 dial converter is also required. P.C. board or Rack Mount available.

RAP-2 PC \$99.50 Rack \$149.50

Sh. Wt. 2 lbs. Sh. Wt. 8 lbs.

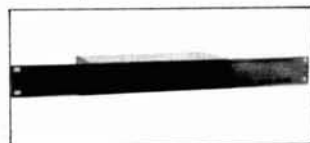

### DELUXE

#### P.C. KEYS

In either a 5 volt TTL or a 9 volt C-MOS version this new module type IC keyer can be easily adapted to your own custom package or equipment. Versatile controls allow wide character weight variations, speeds from 5 to 50 w.p.m. plus volume and tone control. Solid-state output switching saves power, eliminates all those annoying relay problems and is compatible with both grid block and solid-state circuitry. With its side-tone monitor and 90 day warranty the Data Signal PC Keyer is the one for you.

TTL Keyer Wired \$19.95; Kit \$14.95

C-MOS Keyer Wired \$24.95; Kit \$19.95



### DELUXE RECEIVER PREAMP

Specially made for both OLD and NEW receivers. The smallest and most powerful single and dual stage preamps available. Bring in the weakest signal with a Data Preamp.

FREQ. (MHz)	USE	STAGES	DELUXE PREAMPLIFIER			
			GAIN dB	NF dB	KIT	WIRED
144 to 148	2 METER	SINGLE	20	2.5	\$ 9.50	\$12.50
		DOUBLE	40	2.5	\$18.50	\$24.50
1 thru 30	HF BROADBAND		19-36	3	—	\$17.95

Others Available.

Order Today — Send for Free New Catalog

# DATA SIGNAL, INC.

2212 PALMYRA ROAD, ALBANY, GA. 31701, 912-435-1764



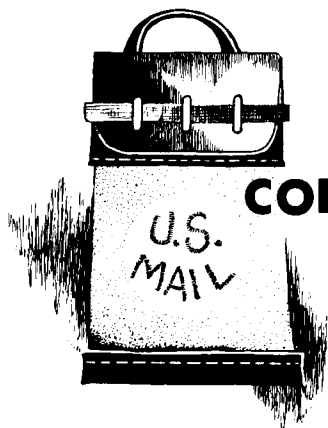

## comments

### microstripline preamplifiers

Dear HR:

WA6UAM's article on "Microstrip Preamplifiers for 1296 MHz,"<sup>1</sup> with a few exceptions explained below, is an excellent article. Having worked with stripline for several years, especially in development of the TIROS-ESSA antenna matching circuitry, I can attest to the value of such a practical construction article for the uhfer. It was also very timely, as more and more amateurs are starting to use stripline techniques to build uhf equipment.

However, in the design section of the article, several unfortunate errors and contradictions appear in the treatment of the S-parameter reflection coefficients and impedances, which are confusing and misleading, even to one who is familiar with S-parameter techniques. The confusion begins in the first paragraph on page 22, where the author states that complex impedances are generally shown in polar form, but can be converted to rectangular form through use of the Smith chart, as per instructions in the caption of fig. 12. The inference is quite clear that the conversion intended is between the polar and rectangular forms of an equivalent value of *impedance*. However, it is not *impedance* which is being converted, and furthermore, the Smith chart cannot perform this type of conversion. Therefore, the inference is incorrect.

The confusion is compounded in the

1. H. Paul Shuch, WA6UAM, "Microstripline Preamplifiers for 1296 MHz," *ham radio*, April, 1975, page 12.

next paragraph, where it is stated that **table 1** lists complex *impedances* in both polar and rectangular forms, while in the table itself both the polar and rectangular forms are stated to be *reflection coefficients*. This contradiction needs clarification, and the statements emphasize the previous, erroneous inference that the associated values appearing in polar and rectangular form in the table are numerically equivalent, while in fact they are not.

The confusion can be easily cleared up as follows: First, it is evident that the author is randomly interchanging reflection coefficient and impedance, confusing the polar-form reflection coefficient with the polar-form equivalent of the rectangular-form impedance. The two are not the same!

Impedance,  $Z = E/I$ , describes the relation between voltage and current in a circuit. Reflection coefficient,  $\rho$ , on the other hand, is the relationship between two voltages (the reflected and the incident) in a circuit containing two impedances at a junction, or two currents in the same circuit:

$$\bar{\rho} = \frac{E_{\text{reflected}}}{E_{\text{incident}}} = -\frac{I_{\text{reflected}}}{I_{\text{incident}}}$$

Accordingly, to clarify the first paragraph on page 22 of WA6UAM's article, the phrase "complex *impedances* in polar form . . ." is a mistatement which should be changed to read "complex *reflection coefficients* are generally shown in polar form, which can be converted to *impedance* in rectangular notation ( $R \pm jX$ ) on a Smith chart as indicated in **fig. 12**" (after the caption of **fig. 12** is also corrected).

Second, the complex numbers appearing in *polar* form in **table 1** are reflection coefficients, and the rows containing the polar-form values should be so labelled. Third, the complex numbers appearing in *rectangular* form in **table 1** are the *impedances* which will

give rise to the accompanying value of reflection when terminating a line or source having an impedance of 50 ohms. In other words, taking an example from the second HP-25826E column, the  $12.5 + j0.5$  value is *not* the rectangular equivalent of the polar value  $0.61 \angle 178^\circ$ , but is the complex impedance which will *yield* the complex reflection coefficient  $\bar{\rho} = 0.61 \angle 178^\circ$  when the impedance  $12.5 + j0.5$  terminates a 50-ohm line or source. The rows containing complex numbers in the rectangular form should therefore be specifically labelled *impedance*  $S_{11}$  or  $S_{22}$ , as appropriate. Proof that the rectangular-form impedance is not equivalent to the listed polar value is further shown by the fact that the polar equivalent of the impedance  $12.5 + j0.5$  is actually  $12.51 \angle 2.29^\circ$ , and *not*  $0.61 \angle 178^\circ$ .

Fourth, as constructed in **figs. 9, 10, 11 and 13**, the graphs containing the  $S_{11}$  and  $S_{22}$  plots should be labelled *impedance*, not "reflection coefficient" because the only loci-identifying coordinates in the graphs are the resistance and reactance circles. The S-parameter graphs in the Hewlett-Packard design catalog<sup>2</sup> from which the figures in the article were taken contain *two* sets of coordinates by which the loci may be identified: resistance- and reactance-circle coordinates to identify the loci as impedances, *and* radial magnitude and angle coordinates to identify the loci as reflection coefficients. Thus the user could use whichever set of coordinates he desired to read the loci as impedances or reflection coefficients.

It is apparent in unravelling all this confusion that a misunderstanding also exists concerning the basic functions of the Smith chart. The function which the Smith chart is really performing in **fig. 12** is the conversion from the complex

2. "Diode and Transistor Designers Catalog," Hewlett-Packard, May, 1974.

reflection coefficient in the polar form to the normalized impedance in the rectangular form. The magnitude (radius) and angle  $0.8 \angle -50^\circ$  in fig. 12 define a specific point in reflection-coefficient coordinates of the chart, while normalized impedance is found at this same point where the  $r$  and  $x$  impedance coordinates of 0.6 and 2.0 intersect, respectively. It cannot be emphasized too strongly that the chart is *not* converting impedance in the polar form to its equivalent impedance in the rectangular form.

Polar-to-rectangular conversion of equivalent impedances is relatively simple to calculate using the Pythagorean theorem. However, conversions between reflection coefficient and impedance are more difficult to calculate, hence the Smith chart is used to simplify reflection-to-impedance conversions. As a point of interest, polar-to-rectangular impedance conversions *can* be performed with an overlay combination of Smith and Carter charts having the same diameters (the Carter chart has impedance coordinates arranged to identify impedance in polar form). With the Smith-Carter overlay the user may enter the Smith chart in rectangular form and the corresponding point on the Carter chart is the polar-form equivalent. As a further point of interest, here is the expression for calculating the conversion from a complex reflection coefficient  $\bar{\rho}$  to normalized impedance:

$$\frac{Z}{Z_c} = \frac{R + jX}{Z_c} = \frac{1 + \bar{\rho}}{1 - \bar{\rho}} = \frac{1 + \rho L \theta}{1 - \rho L \theta}$$

$$= \frac{1 + \rho \cos \theta + j \rho \sin \theta}{1 - \rho \cos \theta - j \rho \sin \theta}$$

Going in the opposite direction, to determine the reflection set up by a given complex impedance loading a line of impedance  $Z_c$ , we have

$$\bar{\rho} = \rho L \theta = \frac{R + jX - Z_c}{R + jX + Z_c}$$

# BULLET ELECTRONICS

• 48HR MAIL SERVICE

• POSTAGE PAID on all orders over \$5.00

• 10% Discount on orders over \$50.00

• CASH REFUNDS on out of stock items.

• QUALITY PARTS & KITS

Send 25¢ for Catalog FREE WITH ORDER

## CK-04 ALARM CLOCK KIT

- Drilled & Plated boards
- Quality transistors
- Six large .4" MANG4 readouts
- Transformer
- Speaker, switches, wire, & instructions
- 50252 Chip



COMPLETE KIT

**21.95**

less case & cord

12hr/60hz  
or  
24hr/50hz

WE GIVE YOU EVERYTHING YOU NEED to build a Large Digit Alarm Clock

**\$5.75**

WOOD CASE for CK-04 Kit  
Sloping front  
Red Plexiglas Front  
With all hardware

ASSORTED  
SLIDE SWITCHES  
minis, standard, spst,  
dpst, dpdt, dp4t, and  
more!  
12pk for 99c

MINI POWER SUPPLY KIT PS-02  
Build your own +5 volt power Module  
at a fraction of commercial cost!

+5 volt regulated @ 400 MA  
with overload protection  
low ripple for TTL work!

- Drilled & Plated Board
- All Components
- Complete Instructions
- Transformer

**PS 01**



POWER SUPPLY KIT

Compare with kits selling  
for much more

**12.95**

uses 78L05 & 78L15  
regulator chips

DRILLED PLATED BOARD  
QUALITY COMPONENTS  
TRANSFORMER INCLUDED

+5 @ 1.5A  
+15V @ 150ma  
Regulated  
Low ripple



**\$4.95**

3 for \$12.50

Everybody we told about this kit said it was "too cheap - you should sell it for more" ... but we think the buyer can recognize a super deal SO HERE IT IS!!

**C**apacitor  
**D**ischarge  
**I**gnition  
**KIT**

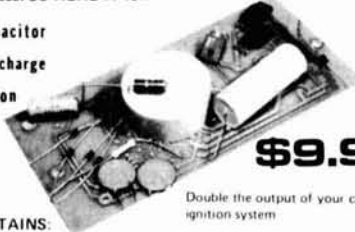

**\$9.95**

Double the output of your cars' ignition system

CONTAINS:

- PC BOARD
- SPECIAL TOROID TRANSFORMER
- 2 100W Power Transistors
- 8A SCR
- 4 800 Volt Diodes
- All resistors & caps
- COMPLETE INSTRUCTIONS

Does not need a special coil  
Easy to install

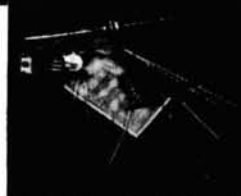

**LOUD!**  
10 WATT WARBLE ALARM KIT  
All the components you need to build a dual tone warble alarm but the speaker.  
Complete with PC Board

6-15VDC \$2.50 complete

Programmed Diode Array  
**ONE-OF-TEN TO BCD Encoder**  
Great for Keyboard encoder,  
frequency synthesizers, etc.  
14 PIN DIP 1.45 ea.

HEATSHRINK TUBING SPECIAL

#1 assorted one foot lengths  
of 3/64, 1/16, 1/8, & 1/4"  
10 pieces .49

#2 assorted one foot lengths  
of 3/8, & 1/2"  
6 pieces .49

CRYSTAL TIME BASE KIT

**\$9.88**



TB 50( 50KHZ model)  
TB 60( 60KHZ model)  
01% accuracy (.002% typ)  
5ma at 12VDC  
Works With most clock  
chips

**7490** decade counters 65¢

**75491** quad segment driver 55¢

**75492** hex digit driver 55¢

- NO CODS.
- Check or MO
- Include 50¢ handling on orders under \$5.00
- Fla. residents Add 5% tax

BULLET ELECTRONICS  
PO BOX 1465  
Lake Worth, Florida 33460

## VANGUARD NOW HAS THE WORLD'S LARGEST SELECTION OF FREQUENCY SYNTHESIZERS FROM \$129.95

You'll never  
have to buy Crystals  
again!



AVAILABLE FOR  
AIRCRAFT, FIRE, POLICE  
AND AMATEUR FREQUENCIES

SEND NO MONEY.  
WE SHIP C.O.D.  
ORDER BY PHONE  
AND SAVE TIME.

We ship open account only to U.S. and  
Canadian government agencies, univer-  
sities and selected AAA rated corpora-  
tions.

### Check these features:

- Smallest size of any commercially available synthesizer — only 1-3/8" x 3-3/4" x 7".
- Excellent spectral purity since no mixers are used.
- .0005% (5 parts per million) accuracy over the temperature range of -10 to +60 C.
- Immune from supply line voltage fluctuations when operated from 11 to 16 volts D.C.
- Up to 8000 channels available from one unit. Frequency selected with thumbwheel switches.
- Available from 5 MHz to 169.995 MHz with up to 40 MHz tuning range and a choice of 1, 5 or 10 kHz increments (subject to certain restrictions depending on the frequency band selected).
- Top quality components used throughout and all ICs mounted in sockets for easy servicing.
- All synthesizers are supplied with connecting hardware and impedance converters or buffers that plug into your crystal socket.

Vanguard frequency synthesizers are custom programmed to your requirements in 1 day from stock units starting as low as \$129.95 for transmit synthesizers and \$139.95 for receive synthesizers. Add \$20.00 for any synthesizer for 5 kHz steps instead of 10 kHz steps and add \$10.00 for any tuning range over 10 MHz. Maximum tuning range available is 40 MHz but cannot be programmed over 159.995 MHz on transmit or 169.995 MHz on receive (except on special orders) unless the i-f is greater than 10.7 MHz and uses low side injection. Tuning range in all cases must be in decades starting with 0 (i.e. — 140.000 — 149.995 etc.). The output frequency can be matched to any crystal formula. Just give us the crystal formula (available from your instruction manual) and we'll do the rest. We may require a deposit for odd-ball formulas. On pick-up orders please call first so we can have your unit ready.

## VANGUARD LABS

Call 212-468-2720 between 9:00 am and 4:00 pm  
Monday through Friday  
196-23 JAMAICA AVE. HOLLIS, N. Y. 11423

## R-X NOISE BRIDGE

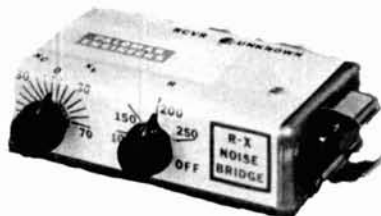

- Learn the truth about your antenna.
- Find its resonant frequency.
- Find R and X off-resonance.
- Independent R & X dials greatly simplify tuning beams, dipoles, quads.
- Connect to antenna and to receiver. Tune receiver to desired frequency. Listen to loud noise. Turn R and X dials for null. Read R direct from dial. X dial tells if antenna is too long ( $X_L$ ), too short ( $X_C$ ), or on frequency ( $X=0$ ).
- Compact, lightweight, battery operated.
- Simple to use. Self contained.
- Broadband 1-100 MHz.
- Free brochure on request.
- Order direct. \$39.95 PPD U.S. & Canada  
(add sales tax in Calif.)

## PALOMAR ENGINEERS

BOX 455, ESCONDIDO, CA 92025  
Phone: (714) 747-3343



Radio  
Amateurs  
Reference  
Library  
of Maps  
and Atlas

**WORLD PREFIX MAP** — Full color, 40" x 28". Shows prefixes on each country . . . DX zones, time zones, cities, cross referenced tables

**\$1.25**

**RADIO AMATEURS GREAT CIRCLE CHART OF THE WORLD** — from the center of the United States! Full color, 30" x 25", listing Great Circle bearings in degrees for six major U.S. cities: Boston, Washington, D.C., Miami, Seattle, San Francisco & Los Angeles.

**\$1.25**

**RADIO AMATEURS MAP OF NORTH AMERICA!** Full color, 30" x 25" — includes Central America and the Caribbean to the equator, showing call areas, zone boundaries, prefixes and time zones, FCC frequency chart, plus useful information on each of the 50 United States and other Countries

**\$1.25**

**WORLD ATLAS** — Only atlas compiled for radio amateurs. Packed with world-wide information — includes 11 maps, in 4 colors with zone boundaries and country prefixes on each map. Also includes a polar projection map of the world plus a map of the Antarctica — a complete set of maps of the world. 20 pages. Size 8 3/4" x 12"

**\$2.50**

**Complete reference library of maps — set of 4 as listed above**

**\$3.75**

See your favorite dealer or order direct.

Mail orders please include 75¢ per order for postage and handling.

RADIO AMATEUR

WRITE FOR  
FREE  
BROCHURE!



callbook INC.

Dept. E 925 Sherwood Drive  
Lake Bluff, Ill. 60044

Two additional errors of lesser importance are, first, on page 25 at the beginning of column 2, the shunt equivalent value of the series impedance  $40 + j25$  ohms should be changed from  $34.8 + j55.6$  ohms, to read  $55.6 + j89$  ohms. And second, the NEC VO21 column of table 1, the reactance  $-j38.5$  in the parallel-circuit input impedance should be changed to indicate a positive reactance.

As a final point of interest, in 1953 the American Standards Association (ASA) adopted the Greek letter rho,  $\rho$  as the symbol to represent reflection coefficient, and many textbook and periodical publishers, as well as manufacturers of S-parameter measuring instrumentation, conformed. Prior to 1953,  $\rho$  was often used to indicate swr, while gamma,  $\Gamma$  and k were used interchangeably to represent reflection. It would be interesting to know why the people at Hewlett-Packard who produce solid-state components continue to use  $\Gamma$ , while those who produce the instruction manuals for their impedance and S-parameter measuring equipment are using  $\rho$ .

Walt Maxwell, W2DU  
Dayton, New Jersey

*W2DU has raised a valid point with regard to the rather loose terminology which I used in my recent article, and I concede that reflection coefficient and impedance are not synonymous, although they are related.*

*Several readers have questioned my failure to consider the transistor's transfer coefficient in calculating the matching networks. Actually, my simplistic design method, which ignores  $S_{12}$  in particular, results in a minute matching error which may be compensated by adjusting the trimmer capacitors at the input and output of the preamplifier.*

*For the benefit of those readers who have inquired about Rollett's stability factor, I should mention that K calculates to greater than unity for all transistor/bias combinations presented in the original article so the amplifiers are unconditionally stable. Nevertheless, I caution the builder to treat them as though they were not. That is, do not apply power until the amplifier is properly terminated in an antenna (or dummy load) and a converter*

H. Paul Shuch, WA6UAM



## HP-65 oscar tracking program

Dear HR:

A program, written for the Hewlett-Packard HP-65 programmable calculator is available for computing both azimuthal and elevation coordinates for tracking either OSCAR 6 or 7. Once the satellite orbital data and individual station positional coordinates are inputted and stored, the routine will compute az/el antenna pointing coordinates for any number of arbitrary, specified times following the ascending node. Az/el coordinates computed with this routine for both ascending and descending passes agree favorably with the results of a FORTRAN program run on a CDC-3800 computer and with actual observed satellite trajectories. The program can be stored on a single HP-65 magnetic card. Documented copies of the program will be forwarded upon request and receipt of a self-addressed, stamped envelope; if a blank magnetic card is included with the request, a copy of the program itself will be sent.

Earl F. Skelton, WA3THD  
Washington, DC

## lower telephone rates

Dear HR:

I am sure many of the readers of *ham radio* have seen the recent ads run by the telephone company depicting the new, low long-distance rates. For the minimum of one minute for 56¢ (at times, even less, depending on the distance) one may call coast to coast. In the evenings, from Sunday to Friday, 8 pm to 11 pm, a one-minute telephone call costs 36¢ or less. For nights and weekends, every night from 11 pm to 8 am and Saturdays and Sundays, the first minute is only 22¢.

It occurs to me that many hams who wish to communicate with another ham anywhere in the U.S., may alert the other party by placing a one-minute call, which would be all the time necessary to convey information as to frequency and a scheduled time. Previously, minimum rates were for 3 minutes and at triple the price. It's a good point to keep in mind when wishing to get another station on the air.

David Greene, W2IAO  
West Orange, New Jersey

## 6 Digit LED Clock Kit - 12/24 hr.

**\$950** IN QUANTITIES  
ea. OF 1 TO 5

**\$850** IN QUANTITIES  
ea. OF 6 OR MORE

### KIT INCLUDES:

- INSTRUCTIONS
- GUARANTEED COMPONENTS (Factory Prime)
- MONEY BACK GUARANTEE
- 50 or 60 Hz OPERATION

- 6 - LED Readouts (FND-70 .25 in.)
- 1 - MM5314 Clock Chip (24 pin)
- 13 - Transistors
- 3 - Switches
- 3 - Capacitors
- 5 - Diodes
- 9 - Resistors

ORDER KIT #850  
AN INCREDIBLE VALUE!

Printed Circuit Board for above (etched & drilled Fiberglass) .....\$2.95  
Transformer for above (7-10V AC) .....\$1.50  
Plexiglas Cabinet II, Red Chassis, White Case,  
2 1/2" H x 4 1/2" W x 5 1/2" D (see below) .....\$5.95

## 6 Digit LED Clock-Calendar-Alarm Kit

• 12/24 HR TIME • JUMBO DIGITS (MAN-64) • 28-30-31 DAY CALENDAR • AC FAILURE/BATTERY BACK-UP • 24 HR ALARM - 10 MIN. SNOOZE • ALTERNATES TIME (8 SEC) and DATE (2 SEC) OR DISPLAYS TIME ONLY and DATE ON DEMAND • 50/60 Hz OP. • THIS KIT USES THE FANTASTIC CT-7001 CHIP. FOR THE PERSON THAT WANTS A SUPER CLOCK KIT (TOO MANY FEATURES TO LIST)! THIS IS A COMPLETE KIT (LESS CASE) including Power Supply, Line Cord, Drilled PC Boards, etc. **39.95** ORDER KIT #7001B (CASE NOT INCLUDED)

KIT #7001-C SAME AS #7001-B BUT HAS DIFFERENT LEDs. USES 4 DL-747 .63" DIGITS & 2 MAN-7 .3" DIGITS FOR SECONDS. COMPLETE KIT, Less Case. **\$42.95**

### CABINET I

3" HIGH  
6 1/4" WIDE  
5 1/2" DEEP



GREAT FOR CLOCK KITS. White Plexiglas Case Specify RED or GRAY Plexiglas Chassis

Chassis Serves As Bezel To Increase Contrast of Digital Displays. Use Gray With Any Color - Red With Red Displays Only (Red LED's with Red Chassis Brightest)

**\$6.95 ea.**

### CABINET II

2 1/2" HIGH  
4 1/2" WIDE  
5 1/2" DEEP



GREAT FOR SMALLER CLOCK KITS. (Ideal for Kit #850 above. All Plexiglas Red Chassis, White Case.)

Red Chassis Serves As Bezel To Increase Contrast of LED Displays.

**\$5.95 ea. - 6 or more \$4.95 ea.**

### PLEXIGLAS FOR DIGITAL BEZELS

Gray or Red Filter  
3" x 6" x 1/8" Approx. Size

**75¢ ea.**  
or **6/\$3.50**

### XTAL TIME BASE KIT for Clock-Calendar-Alarm Kit

Uses 100.800 KHz xtal. Can be used with #7001 Kits only. **\$9.95**

## — COMPONENT SPECIALS —

### MICROPROCESSORS

**8008** LTD. QTY. **\$9.95 ea.**

2102-1 1K RAM **\$3.95 or 10/\$37**

FACTORY PRIME  
.3" RED 7-SEG. LED  
**MAN-7**

**.95 ea., 10/\$8.50, 100/\$79**  
In Sealed Factory Pkg.

### 25 AMP FULL WAVE BRIDGE 100 PIV

**\$1.95 ea.**  
**3/\$5.00**

# OPTOELECTRONICS, inc.

BOX 219 • HOLLYWOOD, FLA. 33022 • (305) 921-2056

BankAmericard, Mastercharge or C.O.D. orders accepted by phone day or evening. We Pay All Shipping in Continental U.S.A. Orders under \$15 add \$1 handling. Fla. res. add 4%.



## FROM SOUND TO SIGHT

NOW - SEE MORSE CODE DISPLAYED - AUTOMATICALLY - AT SELECTED SPEED -



One easy connection from your speaker to the Alpha-Numeric Display of your Code Reader CR-101. Displays all letters, numbers, punctuation. Operating speed 5-50 WPM. Easy to use teaching aide. Handicapped persons can learn new skills. CR-101 large .6 in readout - \$225.00. CR-101A has smaller .2 in readout - \$195.00.

TU-102 TTY interface provides CR, LF, figures and letters automatically - \$85.00. 6 Month Guarantee

all Parts and Labor.

Call me at  
(714) 745-1971

ATRONICS BOX 77, ESCONDIDO, CA 92025

# the ham notebook

## versatile audio oscillator

Here's a versatile audio oscillator which can be put to many uses including an audible logic indicator, sidetone oscillator, code-practice oscillator, square-wave signal generator and many others.

In the circuit of fig. 1 transistors Q2 and Q3 are arranged as a basic collector-coupled astable multivibrator; power is taken from the collector of

The frequency of oscillation is essentially independent of the B1 supply voltage and is determined by:

$$f = \frac{1}{0.69(C1 \cdot R5 + C2 \cdot R4)}$$

If R4 = R5 and C1 = C2, then the output will be a symmetrical square wave. The frequency of oscillation can be varied by changing the value of

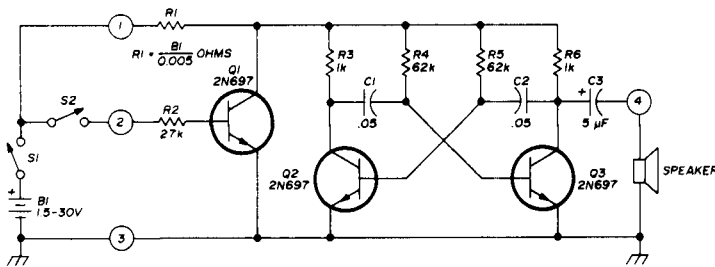

fig. 1. Versatile audio oscillator circuit which may be used as an automobile headlight indicator, audible logic indicator, sidetone oscillator or square-wave signal generator. Oscillation frequency can be varied by changing R4 or R5.

Q1 which acts as a switch for Q2 and Q3. With S1 closed and S2 open, Q1 is cut off and the B1 battery potential is furnished to Q2-Q3 through R1. With both S1 and S2 closed, Q1 is saturated and its collector potential drops to near ground; therefore, no voltage is available for Q2-Q3 and oscillation ceases.

either R4 or R5 or both; however, if R4 and R5 are not changed a like amount, output symmetry will be lost. With the circuit values shown, a 100k pot in series with a 20k resistor could be substituted for R5.

The oscillator output is taken from the Q3 collector via C3. The size of C3 has a marked effect on output volume

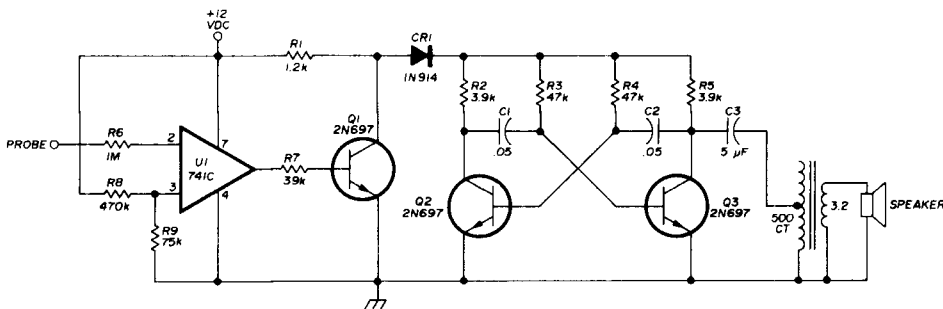

fig. 3. Using the audio oscillator as an audible logic indicator. Oscillator is isolated from the logic by op amp U1 which is wired as a Schmitt trigger.

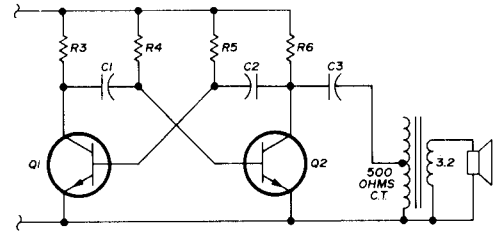
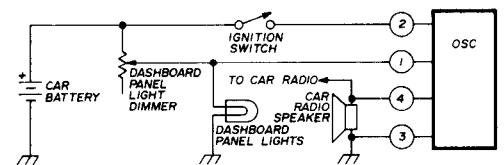

fig. 2. Slightly more audio output can be obtained from the oscillator of fig. 1 by using an audio output transformer.

when a low-impedance load, such as a speaker, is used. Values of 2 μF or larger are quite satisfactory for all impedance loads and will furnish ample audio volume. If only high-impedance loads are used such as 2k headphones, a 0.05 μF disc capacitor will provide adequate audio coupling. If a better impedance match and slightly more volume are desired, an audio output transformer may be used (fig. 2).

When used as an automobile headlight reminder (with a negative-ground car) connect the circuit as follows:



Power for the oscillator is derived from the dashboard panel lights, which are turned on simultaneously with either the parking lights or headlights. If the ignition key is turned on, Q1 saturates and disables Q2-Q3; with the ignition off Q1 is cut off and the Q1 collector voltage rises, providing power to Q2-Q3. The audio output may be connected directly to the car radio speaker voice coil high side without affecting car radio operation.

By connecting the oscillator port 1 to the panel lights the oscillator may, if desired, be purposely disabled with

# The Transceiver you'd expect in 1980



## is ready-now!

the ignition off and lights on merely by dimming the dashboard panel lights. Current drain of the oscillator on the car battery is virtually negligible. The oscillator may be permanently wired to and powered from the existing dashboard controls without requiring additional controls or switches.

The entire printed-circuit board can be wrapped with electrical insulating tape and strapped to any convenient location under the dashboard out of sight, or mounted in a small Minibox. For connection to the car's electrical system, the proper leads can be easily located with a voltmeter or VOM; once located, simply splice in the appropriate oscillator lead, solder, and wrap the joint with electrical tape.

When used as a sidetone oscillator or code practice oscillator, connect as follows:

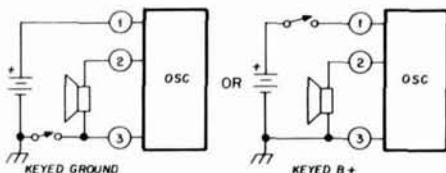

In the above configurations, Q1 and R2 may be eliminated, if desired. The entire oscillator may be constructed on a PC board measuring only 1-1/8 by 3/4 inch (29 by 19mm) if TO-92 transistors are used. For TO-5 transistors the board is slightly larger, 1 1/4 by 7/8 inch (32 by 22mm). Height of the board with components is about 1/2 inch (13mm). Since the circuit is very simple, point-to-point wiring on terminal strips is another alternative if automobile installation is not intended.

Layout of components is not critical, nor is selection of Q1-Q3. Although 2N697s are specified, unmarked npn transistors from surplus

From the company that revolutionized hf ham radio by giving you the first all-solid-state low and medium power equipment, comes the entirely new TRITON IV, a transceiver that is truly ahead of its time. The fore-runner Triton II gave you such operating and technical features as instant transmitter tune, full break-in, excellent SSB quality, superb receiver performance, pulsed crystal calibrator, built-in SWR indicator, a highly selective CW filter and efficient home, portable and mobile operation from non-aging 12 VDC transistors.

Now — the TRITON IV gives you all of these — and more. A new push-pull final amplifier with the latest gold metalized, zener protected transistors, operating at 200 input watts on all hf bands 3.5 through 29.7 MHz. Plus a new crystal heterodyne VFO for improved short and long term frequency stability and uniform 1 kHz read-out resolution, even on ten meters.

Unsurpassed selectivity is yours with the new eight pole i.f. crystal filter, and improved spurious rejection results from the new IC double balanced mixer.

The benefits of ALC now extend to output powers less than full rating with a front panel threshold control. When driving linears that require less than maximum available power from the TRITON, or when propagation conditions permit reliable contacts at reduced power levels, ALC will hold your output to the desired level.

Many small circuit improvements throughout, taken collectively, add more performance and quality pluses — such things as individual temperature compensated integrated circuit voltage regulators for final bias control and VFO supply. And toroid inductances in the ten and fifteen meter low pass filters, LED indicators for offset tuning and ALC threshold, accessory socket for added flexibility, and sequentially keyed mute, AGC and transmitter circuits for even better shaped and clickless CW.

And to top it all off, the highly desirable case geometry has been maintained, but it has a handsome new look. Bold lettering on an etched aluminum front panel and textured black sides and top make the TRITON IV look as sharp as it performs.

There is nothing like a TRITON IV for reliability, features, value and just pure fun. And — best of all — you do not have to wait until 1980 to own one.

For more information about the new TRITON, as well as the full line of accessories that will be available soon, see your dealer or write.



**TEN-TEC**

SEVIERVILLE, TENNESSEE 37862  
EXPORT: 5715 LINCOLN AVE.  
CHICAGO, ILLINOIS, 60646

TRITON IV \$699.00

## FAST SCAN AMATEUR TELEVISION EQUIPMENT

- SOLID STATE
- BROADCAST QUALITY PERFORMANCE
- FOR TECHNICAL DATA AND PRICING, WRITE TO:

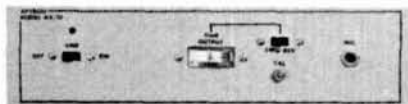

AX-10 TRANSMITTER



AM-1A RCVR MODEM

**APTRON LABORATORIES** BOX 323, BLOOMINGTON, IN 47401

## with TELREX Professionally Engineered

"BALANCED-PATTERN" "PERFECT-MATCH" "BEAMED-POWER"

### Antenna Systems You Are There!

The design, craftsmanship and technical excellence of Telrex —

Communication Antennas.

have made them the standard of comparison throughout the world! Every Telrex antenna model is engineered, precision machined, tuned and matched, then calibrated for easy and correct assembly at your site for repetition of our specifications without 'cut and try' and endless experimentation.

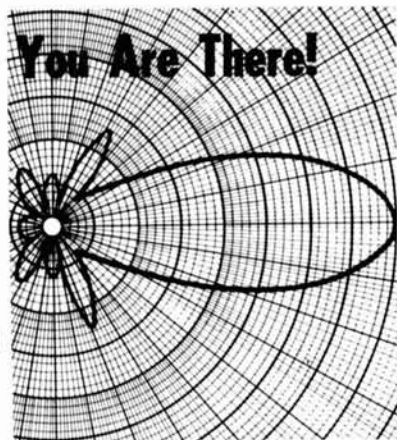

Send for latest free Amateur Catalog

Phone: 201-775-7252

Also: Rotator-Selsyn-Indicator Systems, Inverted-V-Kits, "Baluns," 12-Conductor Control Cable



## WANTED FOR CASH

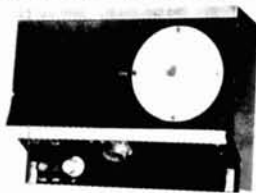

490-T Ant. Tuning Unit  
(Also known as CU1658 and CU1669)

Highest price paid for these units. Parts purchased. Phone Ted, W2KJW collect. We will trade for new amateur gear. GRC106 and PRC74 also required. See HR last issue for other equipment required.



ARC-51 Transceiver



ARC-51 Control Box



R1051 or T827



618-T Transceiver  
(also known as MRC95, ARC94, ARC102, or VC102)

### THE TED DAMES CO.

308 Hickory Street  
(201) 998-4246

Arlington, N. J. 07032  
Evening (201) 998-6475

## VHF FREQUENCY COUNTER

- 5 DIGIT LED DISPLAY
- 10 Hz TO > 230 MHz
- < 200 MV SENSITIVITY
- FACTORY DIRECT SALES
- ASSEMBLED OR KIT

KIT PRICE \$149.95



**\$195<sup>00</sup>**

WIRED & TESTED  
+ \$3.50 POSTAGE  
AND HANDLING

**WEBER Electronics** Elmcrest Terrace, Norwalk, CT 06850

computer boards were used for the fifteen or so automobile headlight units I've built so far; all worked as intended the first time.

For the IC enthusiast, Q1-Q3 can be individual transistors in an array such as the CA3018 (TO-5 case) or the CA3046 (14-pin DIP). However, if ICs are used, a 1N914 diode will be necessary from the Q1 collector to R3; otherwise, it may be omitted.

When the oscillator is used as an audible logic indicator, or audible logic-state indicator, additional isolation of the oscillator from the probed circuit element should be provided to prevent loading the logic circuit. A high-impedance input op-amp is ideal for this application. Fig. 3 shows the circuit.

The op-amp is configured as a poor-man's Schmitt trigger; i.e., a fairly rapid output transition occurs at a specific preset input voltage level by omitting the usual feedback resistor between pins 6 and 2. The op-amp acts simply as a very-high-input-impedance inverter with virtually no hysteresis about the preset transition reference voltage level appearing at the non-inverting input, pin 3. This reference voltage is easily provided by the resistive divider network R8-R9.

Since a TTL-compatible logic probe was desired, the reference level was set for +1.6 volts. The zero logic state maximum voltage for the SN7400 series TTL ICs is about 0.8 volt; the minimum 1 logic level is about +2.4 volts. The +1.6 volt reference level is an arbitrary selection between the two TTL logic levels. When the probe input voltage is below +1.6 volt the op-amp output is approximately 10.5 volts, which saturates Q1 and disables Q2-Q3; when the probe voltage is above +1.6 volt, the U1 output is about 2 volts, which cuts off Q1, and power is supplied to Q2-Q3. R7 must be selected to allow cutoff of Q1 when the U1 output is low, and permit saturation of Q1 when the U1 output is high.

These are just a few of the possible applications for this handy and inexpensive oscillator; further applications are left to the ingenuity and imagination of the reader.

Howard F. Batie, W7BBX



# The New Leader in '76!

## GTX-1 or GTX-1T HAND-HELD 2-Meter FM Transceiver

### CHECK THESE FEATURES:

- All Metal Case
- American Made
- Accepts standard plug-in crystals
- Features 10.7 MHz crystal filter
- Trimmer caps on TX and RX crystals
- 3.5 watts output
- Battery holder accepts AA regular, alkaline or nicad cells
- Mini Handheld measures 8" high x 2.625" wide x 1.281" deep
- Rubber ducky antenna, Wrist safety-carrying-strap included
- 6 Channels
- Factory-direct to You



### Accessories Available:

- Nicad Battery Pack
- Charger for GTX-1 battery pack
- Leather carrying case
- TE III Tone Encoder for auto patch

**GTX-1**  
2 Meter 6 channel  
Hand-Held  
(without encoder)  
**\$249<sup>95</sup>**

**GTX-1T**  
with Built-In  
Tone Encoder  
**\$299<sup>95</sup>**

**GTX-200-T**

2-meter FM, 100 channels, 30 watts (incl. 146.94 MHz)



**GTX-200**

2-meter FM, 100 channels, 30 watts was \$299.95 (Incl. 146.94 MHz)



**GTX-100**

1 1/4-meter FM, 100 channels, 12 watts was \$309.95 (Incl. 223.5 MHz)



**GTX-10**

2-meter FM, 10 channels, 10 watts



**GTX-2**

2-meter FM, 10 channels, 30 watts was \$299.95 (Incl. 146.94 MHz)



**GTX-600**

6-meter FM, 100 channels, 35 watts was \$309.95 (Incl. 52.525 MHz)



**GTX-I**

2-Meter FM, 6-Channel, 3.5 Watts

**\$249<sup>95</sup>**

**GTX-IT**

Same as GTX-1, plus Factory Installed Tone Encoder

Operate Auto Patch  
**\$299<sup>95</sup>**



**PSI-11 Battery Pack** (with charger) @ \$109.95 \$\_\_\_\_\_

**ARX-2 2-M Base Antenna** @ \$29.95 \$\_\_\_\_\_

**Lambda/4 2-M Trunk Antenna** @ \$29.95 \$\_\_\_\_\_

**TE-I Tone Encoder Pad** @ \$59.95 \$\_\_\_\_\_

**TE-II Tone Encoder Pad** @ \$49.95 \$\_\_\_\_\_

**PSI-9 Port. Power Package** (less batteries) @ \$29.95 \$\_\_\_\_\_

**PS-1 AC Power Supply** @ \$69.95 \$\_\_\_\_\_

and the following **standard crystals** @ \$4.50 each: \_\_\_\_\_ \$\_\_\_\_\_

**Non-standard crystals** @ \$6.50 each: \_\_\_\_\_ \$\_\_\_\_\_

For factory crystal installation add \$8.50 per transceiver.

Sub-Total: \$\_\_\_\_\_

(allow 8 weeks delivery.) **TOTAL:** \$\_\_\_\_\_ (minimum order \$12.00)

IN residents add 4% sales tax; CA residents add 6% sales tax; \$\_\_\_\_\_ All orders shipped post-paid within continental U.S.

PHONE \_\_\_\_\_

NAME \_\_\_\_\_ AMATEUR CALL \_\_\_\_\_

ADDRESS \_\_\_\_\_ CITY \_\_\_\_\_ STATE & ZIP \_\_\_\_\_

Payment by:

Certified Check/Money Order  Personal Check  C.O.D. Include 20% Down

Note: Orders accompanied by personal checks will require about two weeks to process.

20% Down Payment Enclosed. Charge Balance To:

BankAmericard # \_\_\_\_\_ Expires \_\_\_\_\_

Master Charge # \_\_\_\_\_ Expires \_\_\_\_\_ Interbank # \_\_\_\_\_

CLIP OUT AND ORDER NOW



General Aviation Electronics, Inc.,  
4141 Kingman Drive,  
Indianapolis, Indiana 46226  
Area 317-546-1111

Use This Handy Order Form



## two-meter fm transceiver

The new products announcement of Standard's new Horizon 2, a 12-channel, 25-watt vhf fm transceiver, in the November issue of *ham radio* contained a typographical error: the correct amateur price is \$295.00. Contact your local dealer for further details.

## vhf fm power amplifiers



The new M-Tech P50A1 vhf power amplifier is designed specifically for amateurs with low power two-meter fm transceivers or hand-held units — 1 to 3 watts input will deliver 40 to 65 watts output. The P50A1 is designed for operation with a 13.6-volt power supply (8 amps) and is rated for an 85% duty cycle. The unit includes COR switching with an LED indicator and a spurious output filter, and is priced at \$139 post-paid.

Other 144-MHz fm power amplifiers in the M-Tech line include the P15A1 (1-3 watts input, 12-25 watts output, 100% duty cycle) which features solid-state switching and is priced at \$59; the P50A10C (2-18 watts input, 14-60 watts output, 100% duty cycle), \$98; the P100A10 (5-12 watts input, 60-100 watts output, 85% duty cycle), \$198; the P100A20 (18-35 watts input, 80-100 watts output, 85% duty cycle), \$155; and the P100A5 (2-5 watts input,

40-100 watts output, 85% duty cycle), \$198. All amplifiers are vswr protected for any load, include a reverse current protection circuit, use microstrip inductors for stability, and carry a 1-year factory warranty. All amplifiers except the P15A1 feature COR switching with an LED indicator and a spurious output filter.

M-Tech also manufactures two solid-state power amplifiers for the 220-MHz band, the P30A1-220 (1-3 watts input, 30-45 watts output, 85% duty cycle) and the P30A10-220 (2-18 watts input, 12-40 watts output, 100% duty cycle). Both of these units feature COR switching with LED indicator.

For more information on M-Tech's *Quality Emphasis Line* of vhf-fm power amplifiers, write to M-Tech Engineering, Inc., Box C, Springfield, Virginia 22151, or use *check-off* on page 102.

## random-wire antenna tuner

If you like portable operation and want to get on the air with the least amount of trouble, a random-length wire antenna is hard to beat. You'll need a tuner for the random wire, and SST Electronics has the answer with the SST T-1. The SST T-1 tunes from 80 through 10 meters and handles 200 watts. It matches the low-impedance output of your transmitter and the low-impedance input of your receiver to the high impedance of a random-length wire antenna. Simple and foolproof design features an LC circuit and neon-bulb tune-up indicator. It's compact, only 3 by 4¼ by 2-3/8 inches (7.6 by 11x1cm). The SST T-1 sells for \$24.95 postpaid and is guaranteed for 90 days against defects in parts and workmanship. For more information, write SST Electronics, P. O. Box 1, Lawndale, California 90260, or use *check-off* on page 102.

## power-line monitor

A new compact high-low power-line monitor with a convenient swivel plug for use directly in an ac outlet or through a standard multi-socket cube is now available from RCA. This small inexpensive test instrument is an ideal tool for every amateur's toolbox and reads from 50 to 150 volts ac (true rms), 50-60 Hz with a plus or minus 5 per cent accuracy. Circular in shape, the new monitor is only two inches in diam-

eter and one inch deep (5x2.5cm), and weighs only three ounces (85g).

The RCA WV-548A Hi/Low power line monitor is priced at \$9.95. For additional information on RCA Electronic Instruments contact RCA Distributor and Special Products Division, 2000 Clements Bridge Road, Deptford, New Jersey 08096, or use *check-off* on page 102.

## test equipment



The 24-page Tucker Electronics Sales Bulletin lists a wide variety of reconditioned test equipment as well as a dozen different lines of new instruments. Although the bulletin shown above was released in May, new sales bulletins are issued periodically. For your copy, write to Tucker Electronics Company, Post Office Box 1050, Garland, Texas 75040, or use *check-off* on page 102.

## volt-ohm-milliammeter

The Triplet Corporation has introduced an unconventional type of volt-ohm-milliammeter that gives the user an "extra-chance" after misuse . . . and not a repair bill. This virtually indestructible test instrument has built-in protection against accidental high energy overload, is shock resistant to accidental drops up to a five foot (1.5m) height, is of modular construction so that it can be easily and quickly serviced in the field and has been designed to the most rigid safety standards to prevent any hazard of electrical shock to the user. Triplet has aptly named it the "Extra-Chance" model 60.

The new vom has no exposed metal parts, providing complete insulation of the instrument itself, special test leads for increased safety and a three-fuse testing system which greatly reduces fire and explosion hazard under misuse conditions. Two 48-inch (1.2m) long safety

test leads are supplied and connect to the control panel by special safety connectors.

A rugged case molded of black, high impact thermoplastic material in combination with a ruggedized suspension meter result in a vom that is virtually indestructible from accidental drops up to a five-foot (1.5m) height. The meter movement is protected by a diode module; fuses are used for normal overload conditions. A fuse plus two zener diodes are used to protect against high energy fault currents and protect the circuit up to 1000 volts. A separate, sealed battery compartment permits easy external access to batteries and fuses without having to remove other parts of the instrument.

A single range selector switch is used for selecting all 33 ac/dc voltage, ac output, resistance, dc current and decibel ranges from -20 to +52 dB plus the *off* and *test* positions. Accuracy on all dc and resistance ranges is  $\pm 2$  per cent of full scale; ac accuracy is  $\pm 3$  per cent of full scale. The Triplet model 60 (catalog number 3145) comes complete with a one-year parts and labor warranty, safety test leads, batteries, spare fuses and instruction manual, and sells for \$90. For additional information, write to the Triplet Corporation, Department, PR, Bluffton, Ohio 45817, or use *check-off* on page 102.

## seven-segment displays



New high-efficiency solid-state numeric displays, as much as five times brighter than other displays at the same operating current, are now available from Hewlett-Packard. At one-fifth the current, they are equal in brightness to older displays. Their high brightness plus their 0.43 inch (11mm) height makes them ideal for applications in high ambient light conditions. Operating at currents as low as 3 mA, these large displays become practical for use in battery-powered portable instruments. They

# NEW from A & W ELECTRONICS



## B & K PRECISION — MODEL 1801 FREQUENCY COUNTER

Frequency Range: 10 Hz to over 60 MHz typical  
Sensitivity: 30 mV RMS guaranteed  
Input Z: 1 meg/25pF  
Max Input Voltage: (peak AC + DC) 200V @ 500 Hz 100V @ 1 kHz,  
50V @ 40 MHz  
Internal xtal oscillator time base-freq: 10 MHz - Setability:  $\pm 1$  Hz  
Readout: 6 digits with overflow  
Power: 105-130V, 60 Hz, 25W max.  
Size: 3.31 x 8.69 x 10.5" Wt.: 5.5 lb.

PRICE ..... \$230.00

Call or write for FREE B & K Catalog.

Call or Write for info on many other lines including Standard, Regency, Bomar Crystals, etc.

Prepaid Orders accompanied by M.O. or Bank Checks are shipped immediately. U.P.S. C.O.D. also available if specified.

## A & W ELECTRONICS

491 RIVERSIDE AVE. MEDFORD, MA 02155  
617-396-5550



# Great New Turn On



Howard Microsystems introduces MOCO II, the newest and most efficient Morse Code translator in the state of the art.

MOCO II ushers in a new generation of Morse Code Readers. Its central processing unit is combined with computer programmed firmware totalling more than 8,000 bits of memory, which permit MOCO II to translate standard alpha-numeric Morse Code, even punctuation automatically.

Simply connect MOCO II to the speaker leads and then just turn it on. No knobs, no adjustments. One switch calibration automatically determines and displays sending speed.

MOCO II is not a kit. It's completely assembled and tested, includes integral power supply, parallel ASCII and Baudot outputs for existing display units.

PRICE: \$199.00

Available as options are a video display, or a teletype driver with 60 ma. loop supplies.

Order from Howard Microsystems, Inc., 6950 France Avenue South, Minneapolis, MN 55435 (612) 925-2474.

### DISPLAY OPTIONS

- A. Baudot Driver/Interface for TTY ..... \$75.00
  - B. Video Character Display with VHF TV Modulator ..... \$325.00
  - (Kit ..... \$175.00)
- All orders — add \$2.75 shipping/handling

HOWARD MICROSYSTEMS, INC.

# MORE EXPANSION FROM SCS

Specialty Communications Systems is always seeking new and better answers to communication problems. Our years of experience in the Amateur Radio hobby are combined with design and manufacturing expertise to bring you products of exceptional value. Amplifiers, Antennas, and now "Side Kick".

## SIDE KICK Portable Range Booster



Extend the range of your hand held transceiver with this combination Amplifier/Battery Unit. Delivers 25 watts to its antenna.

- 144-148 MHz w/o tuning
- Sealed rechargeable battery & charger
- Military Quality
- Leather case & straps
- Flexible Antenna

- Weight: 3.3 lbs.
- Size: 4 3/4" x 2 7/8" x 6"
- Price: \$199.95
- Coming Soon! Linear Version at \$219.95.

### NEW — NEW — NEW

28-432 MHz Solid State Transceiver System Modules to be available soon!



## Amplifiers for HF and 50-432 MHz bands.

### Typical Features:

- Selectable bias - Linear Class AB for SSB, Class C for FM.
- Variable T-R delay
- SSB mode also usable for low power (<10W.) FM.
- Solid State and microstrip construction.
- No tuning across entire Amateur band.
- Full VSWR and reverse voltage protection.
- Under 1 dB insertion loss in receive.
- 1 Year Warranty.
- Write for details on particular models.

### The DX 'J' ANTENNA:

- Gold-plated aluminum radiators
- Requires **no ground plane**
- VSWR typ. 1.3:1 (146-148 MHz)
- Handles 250 watts plus
- Weight: 8 oz.
- 144 & 220 MHz Models
- Coming Soon — Horizontally polarized models and 440 MHz model.

SPECIAL INTRODUCTORY PRICE \$24.95

Accessory: 15' of RG-58/U w/connector \$4.95

Add for shipping & handling \$2.50

California residents add 6%.

Louis N. Ancliaux, WB6NMT

Write now or contact nearest dealer. Dealer inquiries invited.

## SPECIALTY COMMUNICATIONS SYSTEMS

4519 Narragansett Avenue • San Diego, Calif. 92107  
Louis N. Ancliaux • WB6NMT  
(714) 222-8381



Aha, the SECRET of PC Board success finally revealed. A perfectly balanced lighting tool combining magnification with cool fluorescence. Excellent for fine detail, component assembly, etc. Lens is precision ground and polished.

Regularly \$70.00. Now, over 30% discount (only **\$49.00**) to all licensed Hams, verified in Callbook. Uses T-9 bulb (not supplied).

Include \$3.00 U.S. postage, or \$4.00 in Canada. \$5.00 elsewhere. California Residents include 6% sales tax. Or send stamped envelope for free brochure of other incandescent or fluorescent lamps suitable for all engineers, architects, students, etc.

Mastercharge and BankAmericard accepted

### D-D ENTERPRISES

Dept. A, P. O. Box 7776  
San Francisco, CA 94119

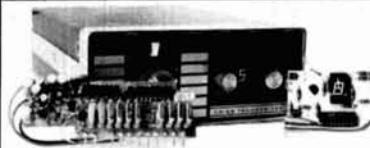

## 10 CHANNEL SCANNER

For All Regency HR series 2, 2A, & 2B, MT-15, MT-25, & AQUAFONE Transceiver

### FEATURES:

- Selectable Priority Channel (Selected By Channel Selector Switch)
- 10 Second Delay Before Scan Resumes after Transmit
- 2 Second Delay Before Scan Resumes After Signal Loss
- Plugs Into Existing Crystal Sockets. Simple 5 Wire Hook-Up Without Major Modification To Radio
- Simple Modification For Selective Channel Bypass
- Optional Digital Channel Display

SCANN 10B 10 Channel Scanner (Wired Only) \$52.50

D10B Digital Channel Display (Wired Only) \$21.75

NET PRICE FOR BOTH \$74.25

HR-2B With Both Installed \$299.99

6T-HR2-3 Crystal Deck (6 more FQ's in HR2, HR-2A) Kit \$11.50

Wired \$15.50

HF 144 U MOSFET Preamp Kit \$11.95, Wired \$17.95

MOTOROLA METRUM II IN STOCK —

WRITE FOR INFORMATION

Topeka FM Communications  
& Electronics  
125 Jackson  
Topeka, Kansas 66603  
913-233-2343

may also be operated in the strobe mode at currents up to 60 milliamperes peak.

The HP models 5082-7650, -7660, and -7670 are red, yellow and green, common-anode, seven-segment displays with lefthand decimal point. LED chips are optically magnified to form evenly-lighted segments. For improved on-to-off contrast, the bodies of the displays are colored to match the appearance of the unlighted segments.

For more information, contact your local Hewlett-Packard Sales Office, or use *check-off* on page 102.

## fet multimeter



A new pocket fet multimeter offering full vtm ranges and a 10-megohm input, completely protected against overload, is now available from Hickok. Packaged in a rugged, pocket-size case with attached cover the Model 350 provides features which include 1 millivolt resolution on three easy-to-read mirrored scales plus dB and battery condition, high/low ohms ranges, and true autopolarity with a polarity indicator.

High impedance fet circuitry permits vtm type ranges in this compact unit. Nine voltage ranges of 0.1 to 1000 volts and seven high/low ohms ranges from 100 ohms to 100 megohms center scale make the Model 350 a versatile service tool. One-year service can be expected from the two 9-volt transistor radio batteries. The Model 350 comes complete with two test leads and instruction manual.

For more information, contact Tom Hayden, Instrumentation & Controls Division, Hickok Electrical Instrument Company, 10514 Dupont Avenue, Cleveland, Ohio 44108, or use *check-off* on page 102.



**Now...**

# **SWAN AUTOMATES THE MOBILE ANTENNA.**



Add the amateur radio mobile antenna to the list of things successfully automated for our increasing comfort.

The Swan Model 742 Triband Mobile, the only automatic amateur radio antenna, eliminates coil changing, tap adjusting, switch flicking and all the rest of mobile antenna inconvenience.

Now for the first time ever you just sit behind the wheel and change from 20 to 40 to 75 meters while your 742 automatically loads itself for each band—perfectly.

Rated at 500 watts P.E.P., the new antenna is one of a complete line of advanced amateur radio antennas and antenna accessories by Swan. All designed to help you put maximum power where you want it.

Model 742 automatic triband mobile antenna. \$79.95.  
Only from Swan. Where else?

Dealers throughout the world  
or order direct from



**SWAN®**  
**ELECTRONICS**

*A subsidiary of Cubic Corporation*

*Home Office:*

305 Airport Road • Oceanside, CA 92054

# NEW FROM MFJ



## SUPER LOGARITHMIC SPEECH PROCESSOR

MODEL LSP-520BX

UP TO 400% MORE RF POWER is yours with this plug-in unit. Simply plug LSP-520BX into the circuit between the microphone and transmitter and your voice suddenly is transformed from a whisper to a DYNAMIC OUTPUT.

Look what happens to the RF Power Output on our NCX-3. It was tuned for normal SSB operation and then left untouched for these "before" and "after" oscillograms.



Fig. 1 SSB signal before processing. See the high peaks and the low valleys. Our NCX-3 is putting out only 25 watts average power.



Fig. 2 SSB signal after processing with LSP-520BX. The once weak valleys are now strong peaks. Our NCX-3 now puts out 100 watts of average power.

Three active filters concentrate power on those frequencies that yield maximum intelligence. Adds strength in weak valleys of normal speech patterns. This is accomplished through use of an IC logarithmic amplifier with a dynamic range of 30dB for clean audio with minimum distortion.

This unit is practically distortion-free even at 30dB compression! The input to the LSP-520BX is completely filtered and shielded for RF protection.

Size is a mere 2 3/16H x 3 1/2W x 4D. Money back if not delighted and ONE YEAR UNCONDITIONAL GUARANTEE.

Order now or write for FREE brochure.  
**LSP-520BX** ..... \$49.95  
 ADD \$1.50 SHIPPING & HANDLING

Here's another product from the plentiful MFJ line:

### SSB FILTER

This filter, packaged very much like the Speech Processor above, allows you to select the optimum audio bandwidth to drastically improve readability.

**SBF-2BX**, assembled and tested \$29.95  
 Write for free catalog on other equipment.

DEALER INQUIRIES INVITED  
 601-323-5869

**MFJ ENTERPRISES**  
 P. O. BOX 494(H)  
 MISS. STATE, MS 39762

# FREE DATA SHEETS WITH EVERY ITEM. IC or FET's WITH \$5 & \$10 ORDERS.\*

- MONEY-BACK GUARANTEE
- 24-HOUR SHIPMENT
- ALL TESTED AND GUARANTEED

<b>TRANSISTORS (NPN)</b>	
2N918 TYPE RF Amp & Oscillator to 1 GHz	3/\$1.00
2N3563 TYPE RF Amp & Osc to 1 GHz (pl. 2N918)	5/\$1.00
2N3565 TYPE Gen. Purpose Gain (TO 92/106)	5/\$1.00
2N3641 TYPE RF & GP Amp & Sw to 500 mA & 30 MHz	5/\$1.00
2N3866 TYPE RF Power Amp 1.5 W @ 450 MHz	\$1.50
2N3903 TYPE GP Amp & Sw to 100 mA and 30 MHz	5/\$1.00
2N3904 TYPE GP Amp & Sw to 100 mA hFE 100	5/\$1.00
2N3919 TYPE RF Power Amp 10 25 W @ 3.30 MHz	\$3.00
2N4274 TYPE Ultra High Speed Switch 12 ns	5/\$1.00
2N5108 TYPE RF Power Amp 2 W @ 450, 1 W @ 1 GHz	\$2.50
MPS6515 TYPE High Gain Amplifier hFE 250	3/\$1.00
Assort. NPN GP TYPES, e.g. 2N3694, 2N3903, etc. (15)	\$2.00
2N3638 TYPE (PNP) GP Amp & Sw to 300 mA	5/\$1.00
2N3906 TYPE (PNP) GP Amp & Sw to 30 MHz	5/\$1.00
2N4249 TYPE (PNP) Low Noise Amp 1 $\mu$ A to 50mA	4/\$1.00
<b>FET's:</b>	
<b>N CHANNEL (LOW NOISE)</b>	
2N4091 TYPE RF Amp & Switch (TO 18/106)	3/\$1.00
2N4416 TYPE RF Amplifier to 450 MHz (TO 72)	2/\$1.00
2N5163 TYPE Gen. Purpose Amp & Sw (TO 106)	3/\$1.00
2N5486 TYPE RF Amp to 450 MHz (plastic 2N4416)	2/\$1.00
E100 TYPE Low-Cost Audio Amplifier	4/\$1.00
ITE4868 TYPE Ultra Low Noise Audio Amp	2/\$1.00
TIS74 TYPE High Speed Switch 40:1	3/\$1.00
Assort. RF & GP FET's, e.g. 2N5163, MPF102, etc. (8)	\$2.00
<b>P CHANNEL:</b>	
2N4360 TYPE Gen. Purpose Amp & Sw (TO 106)	3/\$1.00
E175 TYPE High Speed Switch 125:1 (TO 106)	3/\$1.00

### JANUARY SPECIALS:

2N2222 NPN TRANSISTOR GP Amp & Switch	6/\$1.00
2N2907 PNP TRANSISTOR GP Amp & Switch	6/\$1.00
2N3553 RF Power Amp 5 W @ 150 MHz, 7 W @ 50 MHz	\$2.00
E101 N CHANNEL FET Low Current, Low Vp Amp/Sw	3/\$1.00
MPF102 N CHANNEL FET RF Amp 200 MHz	3/\$1.00
556 DUAL 555 TIMER 1 $\mu$ sec to 1 hour (DIP)	\$1.00
723 VOLT. REGULATOR 3.30 V @ 1.200 mA (DIP/TO 5)	2/\$1.00
741 Op Amp, Freq. Comp., LM 741, $\mu$ A741, etc. (MINI DIP)	4/\$1.00
2740 FET Op Amp, Like NE536 and $\mu$ A740 (TO 5)	\$2.40
$\mu$ A7805 VOLTAGE REGULATOR 5 V @ 1 A (TO 220)	\$1.25
8038 WAVEFORM GENERATOR Wave w/ccts	\$4.50
1N4001 RECTIFIER 50 V PIV, 1A	15/\$1.00
1N4154 DIODE 30 V/10mA 1N914 except 30 V	25/\$1.00
BR1 BRIDGE RECTIFIER 50 V PIV, 500 mA (DIP)	3/\$1.00
MMS314 DIGITAL CLOCK CHIP With Specs/Schematics	\$4.95

<b>LINEAR IC's:</b>	
308 Micro-Power Op Amp (TO 5/MINI DIP)	\$1.00
309K Voltage Regulator 5 V @ 1 A (TO 3)	\$1.25
324 Quad 741 Op Amp, Compensated (DIP)	\$1.50
340T Volt. Reg-1 Amp Specify 5, 6, 12, 15 or 24 V w/ccts	\$1.75
380 2.5 Watt Audio Amplifier 34 dB (DIP)	\$1.29
555 Timer 1 $\mu$ s to 1 hr. NE555, LM555, etc. (MINI DIP)	\$ .65
709 Popular Op Amp (DIP/TO 5)	\$ .29
739 Dual Low Noise Audio Preamp/Op Amp (DIP)	\$1.00
1458 Dual 741 Op Amp (MINI DIP)	\$ .65
741 Freq. Comp. Op Amp (DIP/TO 5)	3/\$1.00

<b>DIODES:</b>	
ZENERS - Specify Voltage 3.3, 3.9, 4.3, 5.1, 6.8, 8.2	400mW 4/\$1.00
9.1, 10, 12, 15, 16, 18, 20, 22, 24, 27, or 33V (-10%)	1 Watt 3/\$1.00
1N914 or 1N4148 TYPE General Purpose 100V/10mA	15/\$1.00
1N3893 TYPE RECTIFIER Stud Mount 400 V/12 A	2/\$1.00
D5 VARACTOR 5.50 W Output @ 30 250 MHz, 7.70 pF	\$5.00
F7 VARACTOR 1.3 W Output @ 100 500 MHz, 5.30 pF	\$1.00

\*MAIL NOW! FREE DATA SHEETS supplied with every item from this ad. FREE ON REQUEST: 741 Op Amp with every order of \$5 or more - 749 Dual Op Amp or two E100 FET's with every order of \$10 or more, postmarked prior to 4/30/76. One free item per order.

ORDER TODAY! All items subject to prior sale and prices subject to change without notice. All items are new surplus parts - 100% functionally tested. WRITE FOR FREE CATALOG - 7510 offering over 350 semiconductors carried in stock. Send 13¢ stamp.

TERMS: Send check or money order (U.S. funds) with order. We pay 1st Class postage to U.S., Canada and Mexico. \$1.00 handling charge on orders under \$10. Calif. residents add 6% sales tax. Foreign orders add postage. COD orders - add \$1.00 service charge.

**ADVA** ELECTRONICS  
 BOX 4181 BE, WOODSIDE, CA 94062  
 Tel. (415) 851-0455

## Synthesizer-for binaural reception



Drilled PC board with Instructions—\$6.95 ppd

Assembled and tested PC board Model 400—\$17.95

PC boards include extra circuitry for trimming & exalted cross-over

Brochures—

**Hildreth Engineering**

P.O. Box 3  
 Sunnyvale  
 Cal. 94088

# CALL SIGNS

FOR  
**TRUNK LID  
 AND  
 HAM SHACK**

## W2CFP

The same sign can display your call in your ham shack and also on your auto when you travel to Hamfests. Made of vacuum molded plastic with imbedded magnets, the sign is removed and relocated in seconds. A 4" x 14" sign as above is only \$9.00. Custom designs available. Sizes to 24" x 48". Let us know exactly what you want.

Dealer inquiries invited!

Our regular store hours are:

Tuesday-Friday 11:00-1:00 p.m.  
 4:00-7:00 p.m.  
 Saturday 10:00-12:00 noon  
 1:00-5:00 p.m.

See us at the same address for all your Amateur Radio needs.

## CFP DYN-A-VAC

Division of CFP Enterprises  
 211 NORTH MAIN STREET  
 HORSEHEADS, NEW YORK 14845  
 Phone: 607-739-0187

## 500 MHZ SCALER MODULE



ONLY 1.55 x 1.65 x .4 INCHES  
 Fits Right Into Existing Equipment.

HIGH SENSITIVITY:  
 35 mv at 500 MHz.  
 15 mv at 150 MHz.

INPUT IMPEDANCE: 50 ohms  
 REQUIRES 12 to 15 VDC at 100 ma. max.

TTL compatible output F<sub>IN</sub> /10  
 OVERLOAD PROTECTED

PS-M Prescaler Module wired & tested.  
 \$99.00 plus \$.85 shipping

Calif. residents add 6% sales tax

WRITE FOR DATA ON ENTIRE LINE OF PRESCALERS  
**LEVY ASSOCIATES**  
 P. O. Box 961 Temple City, CA. 91780



# AMATEUR RADIO

 **THE FM LEADER**



**2 METER**



**220 MHz**

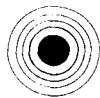

**6 METER**

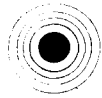

**440 MHz**



ELECTRONICS, INC., 7707 Records Street, Indianapolis, Indiana 46226

# The New DRAKE TV-3300-LP Low Pass FILTER

A  
"Better Mouse Trap"  
in the TV fight!



For use from  
160 meters  
through  
10 meters.

Rating — 1 kW DC.

The new Low Pass Filter is more than 80 dB down at 41 MHz and above! This is the third harmonic of 20 meters and the second harmonic of 15 meters—it's also the I.F. frequency for TV! • The popular TV-1000-LP provides for low power operation on 6 meters and thus cannot roll-off below 52 MHz.  
• Write for the TV-3300-LP curves.

See your Dealer.

For more information please contact:

**R. L. DRAKE COMPANY**



540 Richard St., Miamisburg, Ohio 45342 • Phone: (513) 866-2421 • Telex: 288-017

## DON'T GET RIPPED OFF

### Shur-Lok Mobile VHF Radio Lock



\$14.95

Plus \$1.00  
Shipping  
& Handling

U.S. Patent #3410122

- SHUR-LOK will accommodate a unit with overall dimensions including mounting bracket up to 3 1/2" High and from 4 1/2" to 9 1/4" Wide.
- Prevents access to rig's mounting hardware • No special tools
- Tempered steel no pick Yale lock
- Also great for tape decks
- Satisfaction Guaranteed
- Special pry-proof hardware
- Dealer & Club inquiries invited

You spent \$200, \$300 or \$400 to put your VHF rig in the car. Why not spend \$15 to keep it there!

Order now from National Mfg's. Rep.  
for Amateur Radio Use.

### PRUITT ENTERPRISES

Box 41H Tonopah, NV 89049  
Tel: 702-482-3473

## WANT TO TRADE BINDERS?

Got more small sized **HAM RADIO** Binders than you can use?

Now with our new large sized magazine we'll trade any extra small sized (6" x 9") binders for our new large sized binders for just \$1.00 (\$2.00 foreign) per binder shipping and handling.

Send in any extra binders in new, unused condition still in their original shipping carton along with the wires and date labels plus \$1.00 per binder. We'll ship you a brand new large binder for each small one returned.

Hurry though, this offer is valid only through January 31, 1976.



**HAM RADIO GREENVILLE, NH 03048**

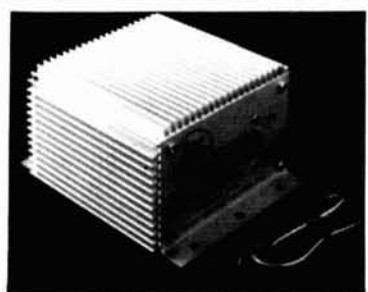

## THE TIGER

### 15% Savings on Gas

A Capacitive Discharge Ignition system absolutely guaranteed NOT to interfere with your radios & equally guaranteed to improve your auto's operation and gas mileage.

No rewiring necessary. Engine cannot be damaged by improper installation. Either of three models fits any vehicle or stationary engine with 12 volt negative ground, alternator or generator system. Uses standard coil & distributor now on your engine. Dual switch permits motor work or tune-up with any standard test equipment.

Write for free booklet that not only is the BEST description of CDIs, but also explains the need for such a system. Current prices assured til July 1, '76.

### D-D ENTERPRISES



P. O. Box 7776



San Francisco, CA 94119

# The Grabbers!

## 6-DIGIT COUNTERS!

6-Digit Kit

\$ **69**.95

(30mHz)



6-Digit Kit

\$ **119**.95

(250mHz)

We have a whole wonderful line of unbelievable counters starting at \$45.95! Drop us a line or give us a call today.

**Hufco** Dept. 11, P.O. Box 357 Provo, Utah 84601 (801) 224-3355

### 7400N TTL

SN7400N	.13	SN7451N	.27	SN74151N	1.25
SN7401N	.16	SN7452N	.27	SN74152N	1.35
SN7402N	.21	SN7454N	.41	SN74154N	1.25
SN7403N	.16	SN7454A	.25	SN74155N	1.21
SN7404N	.16	SN7456N	.22	SN74156N	1.30
SN7405N	.24	SN7470N	.45	SN74157N	1.30
SN7406N	.45	SN7472N	.48	SN74158N	1.65
SN7407N	.45	SN7473N	.37	SN74161N	1.45
SN7408N	.25	SN7474N	.32	SN74163N	1.35
SN7409N	.25	SN7475N	.59	SN74164N	1.65
SN7410N	.16	SN7476N	.32	SN74165N	1.85
SN7411N	.30	SN7480N	.60	SN74167N	5.50
SN7412N	.85	SN7482N	1.75	SN74167N	5.50
SN7413N	.85	SN7483N	1.15	SN74170N	3.00
SN7414N	.70	SN7486N	1.12	SN74172N	18.00
SN7416N	.43	SN7488N	.45	SN74173N	1.70
SN7417N	.43	SN7489N	3.50	SN74174N	1.95
SN7418N	.25	SN7489N	3.00	SN74175N	1.95
SN7420N	.21	SN7490N	.49	SN74176N	.90
SN7421N	.39	SN7491N	1.20	SN74177N	.90
SN7423N	.37	SN7492N	.82	SN74180N	1.05
SN7424N	.43	SN7493N	.57	SN74181N	3.55
SN7426N	.31	SN7494N	.91	SN74182N	.95
SN7427N	.37	SN7495N	.91	SN74184N	2.30
SN7429N	.42	SN7496N	.91	SN74185N	2.20
SN7430N	.26	SN7497N	1.00	SN74186N	2.20
SN7432N	.31	SN74107N	.49	SN74190N	1.50
SN7437N	.47	SN74111N	.45	SN74191N	1.50
SN7438N	.40	SN74122N	.49	SN74192N	1.12
SN7439N	.25	SN74123N	.70	SN74193N	.99
SN7440N	.21	SN74124N	.85	SN74194N	1.05
SN7441N	1.10	SN74126N	.81	SN74195N	1.00
SN7442N	1.08	SN74132N	3.00	SN74196N	1.25
SN7443N	1.05	SN74141N	1.15	SN74197N	1.00
SN7444N	1.10	SN74142N	4.00	SN74198N	2.25
SN7445N	1.10	SN74143N	1.00	SN74199N	2.25
SN7446N	1.15	SN74144N	4.50	SN74200N	2.50
SN7447N	.79	SN74145N	1.15	SN74251N	2.50
SN7448N	.99	SN74146N	2.50	SN74256N	6.00
SN7450N	.26	SN74150N	1.10	SN74256N	6.00

MANY OTHERS AVAILABLE ON REQUEST  
20% Discount for 100 Combined 7400's

### JAMES JANUARY SPECIALS

\*Astrisk Denotes Items On Special For This Month\*

#### \*Special Requested Items\*

RC4194	Dual Track V reg	\$ 5.95	8N397	\$ 3.00	MC5007	\$10.95	MC4004	4.50
RC4195	15V Track Reg	3.25	A024P	2.25	8283	5.95	LM3909	2.25
F3368	Decoder	3.95	2513	11.00	8267	2.75	MMS320	19.95
LD101/111	DVM Chip Set	28.00	2518	7.00	8288	1.15	74279	.90
CA3130	Super CMOS Op Amp	1.49	2524	3.00	8826	3.00	4072AE	.45
MC1408L7	AID	9.85	2525	6.00	8880	1.25	4511AE	2.50
F3341	FRO	8.95	2527	5.00	7497	5.00	4136	2.50

WE'LL BE HAPPY TO QUOTE ON YOUR SPECIAL PARTS -

#### XCITON LITRONIX MONSANTO OPTO ELECTRONICS DISCRETE LEDS

XC209H	5/S1	XC526R	5/S1	XC111R	5/S1
XC209G	4/S1	XC526G	4/S1	XC111G	4/S1
XC209Y	4/S1	XC526Y	4/S1	XC111Y	4/S1
XC209B	4/S1	XC526B	4/S1	XC111B	4/S1

.125" dia.      .185" dia.      .190" dia.

.200" dia.      .200" dia.      .085" dia.

XC22R    5/S1    XC556R    5/S1    MV50    085" dia Micro  
XC22G    4/S1    XC556G    4/S1    red led  
XC22O    4/S1    XC556O    4/S1    6/S1

#### DISPLAY LEDS

TYPE	POLARITY	HT	PRICE	TYPE	POLARITY	HT	PRICE
MAN 1	COMMON ANODE	2.70	\$1.95	MAN 74	COMMON CATHODE	3.00	\$1.50
MAN 2	5 x 7 DOT MATRIX	3.00	3.95	DL747	COMMON ANODE*	6.00	1.95
MAN 3	COMMON CATHODE	1.25	3.95	DL747	COMMON ANODE*	6.00	1.95
MAN 4	COMMON CATHODE	1.87	1.95	DL750	COMMON CATHODE	6.00	2.49
MAN 7	COMMON ANODE	3.00	1.50	DL338	COMMON CATHODE	.110	1.95
MAN 7G	COMMON ANODE-GREEN	3.00	2.50	FND70	COMMON CATHODE	5.00	2.50
MAN 7Y	COMMON ANODE-YELLOW	3.00	2.50	FND503	COMMON CATHODE	500	1.75
MAN 7Z	COMMON ANODE	3.00	1.50	FND507	COMMON ANODE	500	1.75

#### IC SOLDERTAIL - LOW PROFILE (TIN) SOCKETS

Pin	1-24	25-49	50-100	Pin	1-24	25-49	50-100
14 pin	17	16	15	24 pin	3.38	3.7	36
16 pin	22	21	20	28 pin	4.5	4.4	43
18 pin	29	28	27	36 pin	6.0	5.9	58
22 pin	37	36	35	40 pin	.63	.62	.61

SOLDERTAIL STANDARD (TIN)

Pin	1-24	25-49	50-100	Pin	1-24	25-49	50-100
14 pin	\$2.27	\$2.25	24	28 pin	\$9.99	\$9.90	\$8.1
16 pin	\$3.00	\$2.75	25	36 pin	1.39	1.26	1.15
18 pin	35	32	30	40 pin	1.59	1.45	1.30
24 pin	49	45	42				

SOLDERTAIL STANDARD (GOLD)

Pin	1-24	25-49	50-100	Pin	1-24	25-49	50-100
8 pin	\$3.30	27	24	24 pin	\$ 7.70	6.3	5.7
14 pin	35	32	29	28 pin	1.10	1.00	.96
16 pin	38	35	32	36 pin	1.76	1.40	1.26
				40 pin	1.75	1.59	1.45

WIRE WRAP SOCKETS (GOLD) LEVEL #3

Pin	1-24	25-49	50-100	Pin	1-24	25-49	50-100
10 pin	\$4.45	41	37	24 pin	\$1.05	95	.85
14 pin	39	38	37	28 pin	1.40	1.25	1.10
16 pin	43	42	41	36 pin	1.59	1.45	1.30
18 pin	75	68	62	40 pin	1.75	1.55	1.40

#### 50 PCS. RESISTOR ASSORTMENTS \$1.75 PER ASS'T.

ASS'T.	Resistor Values	Wattage
ASS'T. 1	10 OHM, 12 OHM, 15 OHM, 18 OHM, 22 OHM, 27 OHM, 33 OHM, 39 OHM, 47 OHM, 56 OHM	1/4 WATT 5% - 50 PCS.
ASS'T. 2	10 OHM, 22 OHM, 27 OHM, 33 OHM, 39 OHM, 47 OHM, 56 OHM, 68 OHM, 82 OHM	1/4 WATT 5% - 50 PCS.
ASS'T. 3	1.2K, 1.5K, 1.8K, 2.2K, 2.7K, 3.3K, 3.9K, 4.7K, 5.6K, 6.8K, 8.2K, 10K, 12K, 15K, 18K	1/4 WATT 5% - 50 PCS.
ASS'T. 4	50K, 68K, 82K, 100K, 120K, 150K, 200K, 270K, 330K, 470K, 560K, 680K, 820K, 1K	1/4 WATT 5% - 50 PCS.
ASS'T. 5	15K, 18K, 22K, 27K, 33K, 39K, 47K, 56K, 68K, 82K, 100K, 120K, 150K, 200K, 270K, 330K, 470K, 560K, 680K, 820K, 1K	1/4 WATT 5% - 50 PCS.
ASS'T. 6	10K, 12K, 15K, 18K, 22K, 27K, 33K, 39K, 47K, 56K, 68K, 82K, 100K, 120K, 150K, 200K, 270K, 330K, 470K, 560K, 680K, 820K, 1K	1/4 WATT 5% - 50 PCS.
ASS'T. 7	1M, 1.2M, 1.5M, 1.8M, 2.2M, 2.7M, 3.3M, 3.9M, 4.7M, 5.6M	1/4 WATT 5% - 50 PCS.

ALL OTHER RESISTORS FROM 2.2 OHMS - 5.6M AVAILABLE IN MULTIPLES OF 5 ea  
5-25 PCS. .05 ea 30-95 PCS. .04 ea 100-495 PCS. .03 ea 500-995: .027 ea

#### 14 PCS. POTENTIOMETER ASSORTMENTS

ASS'T. A	2 ea. 10 OHM 20 OHM 50 OHM 100 OHM 200 OHM 250 OHM 500 OHM
ASS'T. B	2 ea. 1K, 2K, 5K, 10K, 20K, 50K, 100K
ASS'T. C	2 ea. 50K, 100K, 200K, 500K, 1M, 2M

Each assortment contains 14 pcs of 10 turn pots. All pots are available in single unit quantities. \$9.99 ea.

PRIME INTEGRATED CIRCUIT ASSORTMENTS			
ASS'T. 8	SN7400 7401 7402 7403 7404	55/111	\$5.95 ASS'T.
ASS'T. 9	SN7410 7430 7438 7440 7412		
ASS'T. 10	SN7447 7490 7491 74100 74121		
ASS'T. 11	SN74145 74180 74181 74191 74193	MSI TTL	\$9.95 ASS'T.
ASS'T. 12	CD4061 4012 4013 4017 4018	CMOS	\$7.95 ASS'T.
ASS'T. 13	MC1011 3014 3021 3027 3089		
ASS'T. 14	LM3111 5657 5671 7411 7419	LINEAR	\$10.95 ASS'T.

Satisfaction Guaranteed. \$5.00 Min. Order. U.S. Funds. California Residents - Add 6% Sales Tax. Write for FREE 1976 Catalog - Data Sheets .25¢ each

# JAMES

P.O. BOX 822, BELMONT, CA. 94002  
PHONE ORDERS - (415) 592-8097

#### CMOS

CD4000	.25	74C10N	.65
CD4001	.25	74C20N	.65
CD4002	.25	74C03N	.85
CD4007	2.50	74C06N	1.85
CD4010	.25	74C40	2.45
CD4019	.90	74C74	1.15
CD4020	.59	74C90N	3.00
CD4021	.59	74C93N	3.00
CD4011	.47	74C107N	1.25
CD4012	.25	74C151	2.90
CD4013	.47	74C154	3.00
CD4016	.56	74C157	2.15
CD4017	1.35	74C159	3.25
CD4019	.35	74C161	3.25
CD4020	1.49	74C163	3.00
CD4022	1.25	74C164	3.25
CD4023	.25	74C173	2.60
CD4024	1.50	74C183	2.75
CD4025	.25	74C195	2.75
CD4027	.89	80C97	1.50
CD4028	1.65		
CD4029	2.90		

#### LINEAR

LM100H	15.00	LM1310N	2.95
LM106H	2.50	LM1351N	1.65
LM121H	3.75	LM1414N	1.75
LM127H	7.00	LM1498C	.65
LM300H	.80	LM1555V	.95
LM301H	3/100	LM3800CN	1.05
LM301CA	3/100	LM3811N	1.79
LM302H	.75	LM3821N	1.79
LM304H	1.00	LM3901N	2.95
LM305H	.95	LM3905N	.65
LM307CN	.35	LM3909N	.60
LM308H	1.00	LM3556V	1.85
LM308CN	1.00	LM3568V	1.00
LM309H	1.10	LM3589V	.98
LM309CN	1.25	LM3752N	.58
LM310CN	1.15	LM3758N	2.20
LM311H	.90	LM7534N	2.20
LM311CN	1.50	LM7535N	1.25
LM313H	1.90	NE555V	.45
LM313CN	3.00	NE568V	1.25
LM318H	1.30	NE568V	1.25
LM318CN	3.00	NE660CN	1.95
LM319H	1.30	75451CN	.99
LM319CN	3.00	75452CN	.99
LM320H	1.35	75453CN	.99
LM320CN	3.00	75454CN	.99
LM320K-5	1.35	LM709H	.29
LM320K-12	1.35	LM709N	.29
LM320K-15	1.35	LM729N	.79
LM320K-5	10.50	LM711N	.99
LM324N	1.80	LM723N	.55
LM339N	1.70	LM723H	.55
LM340K-5	1.95	LM735N	1.20
LM340K-12	1.95	LM735H	1.25
LM340K-15	1.95	LM741CN	3/100
LM340T-5	1.75	LM741H	.79
LM340T-12	1.75	LM747H	.79
LM340T-15	1.75	LM747N	.79
LM340N	1.75	LM748H	.90
LM340T-24	1.75	LM748N	.90
LM351CN	6.15	LM1304N	1.19
LM370N	1.65	LM1305N	1.40
LM370H	1.15	LM1307N	.85

#### KITS EXAR ICS

XR 2206KA	SPECIAL \$17.95
XR 2206KB	SPECIAL \$27.95

TIMERS	WAVEFORM GENERATORS	
XR 555CP	XR 205	\$3.20
XR 320P	XR 2206CP	3.20
XR 556CP	XR 2207CP	3.20
XR 556CP		
XR 2240CP		

PHASE LOCKED LOOPS	MISCELLANEOUS	
XR 210	XR 1310P	8.40
XR 215	XR 1800P	3.85
XR 567CP		
XR 2567CP		

#### DATA HANDBOOKS

7400	Pin-out & Description of 5400/7400 ICS	\$2.95
CMOS	Pin-out & Description of 4000 Series ICS	\$2.95
LINEAR	Pin-out & Functional Description	\$2.95

ALL THREE HANDBOOKS \$8.95

### 74LS00 TTL

74LS00	.39	74LS55	.39	74LS151	1.55
74LS02	.39	74LS73	.65	74LS153	1.89
74LS03	.39	74LS74	.65	74LS157	1.55
74LS04	.45	74LS75	.79	74LS162	2.25
74LS05	.45	74LS76	.65	74LS163	2.25
74LS08	.39	74LS83	2.19	74LS164	2.25
74LS10	.39	74LS86	.65	74LS181	3.69
74LS13	.79	74LS90			



# CRYSTAL FILTERS and DISCRIMINATORS



### 9.0 MHz FILTERS

XF9-A	2.5 kHz	SSB TX	\$31.95
XF9-B	2.4 kHz	SSB RX	\$45.45
XF9-C	3.75 kHz	AM	\$48.95
XF9-D	5.0 kHz	AM	\$48.95
XF9-E	12.0 kHz	NBFM	\$48.95
XF9-M	0.5 kHz	CW	\$34.25
XF9-NB	0.5 kHz	CW	\$63.95

### 9.0 MHz CRYSTALS (Hc25/u)

XF900	9000.0 kHz Carrier	\$3.80
XF901	8998.5 kHz USB	\$3.80
XF902	9001.5 kHz LSB	\$3.80
XF903	8993.0 kHz BFO	\$3.80
F-05	Hc25/u Socket	.50

### 9.0 MHz DISCRIMINATORS

XD9-01	± 5 kHz	RTTY	\$24.10
XD9-02	± 10 kHz	NBFM	\$24.10
XD9-03	± 12 kHz	NBFM	\$24.10

Export Inquiries Invited  
Shipping 50¢ per filter

## VHF CONVERTERS UHF

RF Freq. (MHz) †	MMc 50	MMc 144	MMc 220	MMc 432	MMc 1296
IF Freq. †	50-54	144-148	220-224	432-436	1296-1300
N.F. (typical)	28-32	28-32	28-32	28-32	28-32
Nom. Gain	2.5dB	2.8dB	3.4dB	3.8dB	8.5dB
	30dB	30dB	26dB	28dB	20dB

Power 12V D. C.  
1 1/4" x 2 1/2" x 4 1/2" + connectors  
Very low N. F. units on special order.  
†Other ranges, amateur & commercial, to order.

## ANTENNAS

**144-148 MHz**

8 OVER 8 DB/2M  
GAIN, REF DIPOLE 12.6 dB  
FEED 50Ω COAXIAL  
\$43.95

DB/2M — VERT.  
FOR LONG RANGE  
REPEATER ACCESS  
GAIN 12.6dB REF DIPOLE  
FEED 50Ω COAXIAL  
\$52.70

**420-450 MHz**

70/MBM48  
GAIN VARIATION ACROSS  
BAND TYP ± 0.5dB  
FEED 50Ω COAXIAL  
\$56.75

**1250-1340 MHz**

1296 — LY  
1296 MHz LOOP-YAGI  
GAIN +20dB  
FEED 50Ω COAXIAL  
\$51.75

Antennas FOB Concord, Mass.  
via UPS

**LSI** SPECTRUM INTERNATIONAL, INC. P. O. BOX 1084 CONCORD, MASS. 01742 U.S.A.

**STAMP-IT ETCH-IT**

MAKE PROFESSIONAL LOOKING P.C. BOARDS FAST AND EASY

- SENSATIONAL
- REVOLUTIONARY
- FANTASTIC

**STAMP-IT ETCH-IT**

Reduces Printed Circuit Board Art Work From 2 Hours to 10 Min. . . .

Simple as A.B.C.

A. Stamp Components on P.C. Board. B. Use Pen to Interconnect Lines. C. Etch Board.

**SE-2 KIT CONTAINS:**

- CONNECTOR FINGERS
- 16 PIN DUEL IN LINE IC SOCKET
- 10 PIN ROUND IC SOCKET
- 8 PIN ROUND IC SOCKET
- TO-5 TRANSISTOR SOCKET
- TO-18 TRANSISTOR SOCKET
- LARGE & SMALL DONUT PAD
- RESIST INK
- INK PAD
- RESIST PEN

PLUS

**ONLY \$9.95**

**ADDITIONAL STAMPS:**

Bread board stamps for all integrated circuits "Great" for experimenters.

Only \$2.95 each or all four \$9.95

#1 DUEL IN LINE	#2 FLAT PACK
#3 8-PIN ROUND	#4 10-PIN ROUND

- RESIST INK . . . 95¢ per bottle
- RESIST PEN ea. 95¢
- INK PAD ea. \$1.15
- Etching Containers . . . 10 for 95¢

**A.C.E. LABORATORIES**  
P.O. BOX 2366  
Indianapolis, Indiana 46206

Are you tired of the hours of small, detailed, eye-straining art work that goes into making printed circuit boards? A.C.E. LABORATORIES is introducing a NEW product called "STAMP IT, ETCH IT" Kit. This Kit will take the tedious art work and many tiresome hours out of printed circuit board preparation. In just a few short minutes you have a professional looking etched printed circuit board ready for drilling!

The "STAMP IT, ETCH IT" Kit is exactly as the name implies. Following the step by step simple instructions, you can have a printed circuit board and have saved hours of frustration. As easy as you use a rubber stamp to stamp messages on paper, you stamp your component connections on copper clad printed circuit boards.

In your "STAMP IT, ETCH IT" kit we supply all component stamps shown in SE-2 Kit. In the SE-2 kit we also have resist ink enough for months and months of experimenting, ink stamp pad, resist pen, and etching containers. The most revolutionary item in your "STAMP IT, ETCH IT" Kit is . . . The Fool Proof System of etching your printed circuit boards.

With our kits and our etching containers, you are able to etch a printed circuit board as fast as bubble etching machinery and the results are as good or better.

### COAX CONNECTORS

PL 259	.55
SO 239	.50
PL 258 BARREL	1.15
DOUBLE MALE	1.75
M 358 'T' ADAPTER	2.95
M 359 Right ANGLE	1.49
UG 175/U RE-DUCER (RG58/U)	.25
UG 176/U RE-DUCER (RG59/U)	.25
PL 259 P.O. (PUSH ON TYPE)	1.25
UHF F to MOTOROLA M	1.50
UG 255 BNC.M to UHF.F	2.95
UG 273/U UHF.M to BNC.F	1.95
UG 260B/U BNC CABLE END	1.15
UG 274C/U BNC 'T' ADAPTER	2.45
UG 306B/U RIGHT ANGLE	1.75
UG 491B/U DOUBLE MALE	2.45

QUANTITY DISCOUNT  
10 to 99—10% OFF  
100 to 999—15% OFF  
1,000 or MORE—WE WILL QUOTE CURRENT WHOLESALE PRICE!

**SPECIAL SALE**  
OVERSTOCKED WITH BNC CHASSIS MOUNT UG-1094/U 100/\$65—1,000/\$425

24 VCD 4PDT MINI Relay —P&B type KHP w/3 amp contacts Only \$1.49  
DPST Miniature switch #MSG206N 6A at 125 VAC 95¢ each 10/\$7.95

\$5.00 Minimum Order  
PLEASE ADD POSTAGE

### FAN (MINIATURE MUFFIN TYPE)

Rotron Mfg. Sprite Fan 3 1/2" Square x 1.63" thick 2,800 RPM  
33 CFM Ball Bearing Whisper Quiet 14 oz. Great for the small places! BRAND NEW \$9.95 ea.

**STEREO PREAMPS**

High Quality Module Type, wires easily into existing stereo where an equalizer pre-amp state is required, can be used in magnetic cartridges, tape decks, or heads, low impedance microphones, etc. 12 V power source. 20 to 20 KHZ Frequency response, very sensitive. 3" x 4 1/4" x 3/4" BRAND NEW WITH SCHEMATIC. LIMITED QUANTITY—3 for \$2.00 — 10 for \$5.00.

**VIDEO PREAMPS**

Originally made for CARTAVISION VIDEO TAPE SYSTEM. Has many uses.  
2/\$1 — 10/\$4

**3" CRT TUBES**  
**3EP1**  
NEW GUARANTEED  
\$3.95 ea.—4/\$10.00

**DESOLDERING IRON**

Mfgd. by leading company (in U.S.A.) in the soldering tool field. These units are NEW! Slight plating blemish prevents factory from marketing. A 40 watt unit which may be used for soldering as well as desoldering. **WE GUARANTEE!!** ORIGINALY SELLS FOR \$16.95 A.C.E. PRICE \$8.95 each (Limited inventory)

# DIGITAL DATA RECORDER

## for Computer or Teletype Use Up to 2400 Baud

Uses the industry standard tape saturation method to beat all FSK systems ten to one. No modems or FSK decoders required. Loads 8K of memory in 34 seconds. This recorder enables you to back up your computer by loading and dumping programs and data fast as

you go, thus enabling you to get by with less memory. Great for small business bookkeeping. Imagine! A year's books on one cassette.



Thousands are in use in colleges and businesses all over the country. This new version is ideal for instructional, amateur, hobby and small business use. Ideal for use by servicemen to load test programs. Comes complete with prerecorded 8080 software program used to test the units as they are produced. (Monitor)

Thousands are in use in colleges and businesses all over the country. This new version is ideal for instructional, amateur, hobby and small business use. Ideal for use by servicemen to load test programs. Comes complete with prerecorded 8080 software program used to test the units as they are produced. (Monitor)

### SPECIFICATIONS:

- A. Recording Mode: Tape saturation binary. This is not an FSK or Home type recorder. No voice capability. No modem.
- B. Two channels (1) Clock, (2) Data. Or two data channels providing four (4) tracks on the cassette. Can also be used for NRZ, Bi-Phase, etc.
- C. Inputs: Two (2). Will accept TTY, TTL or RS 232 digital.
- D. Outputs: Two (2). Board changeable from TTY, RS232 or TTL digital.
- E. Erase: Erases while recording one track at a time. Record new data on one track and preserve three or record on two and preserve two.
- F. Compatability: Will interface any computer using a UART or PIA board. (Altair, Sphere, M6800 etc.)
- G. Other Data: 110 V - (50-60) Hz; 2 Watts total; UL listed #955D; three wire line cord; on/off switch; audio, meter and light operation monitors. Remote control of motor optional. Four foot, seven conductor remotig cable provided.
- H. Warrantee: 90 days. All units tested at 110 and 2400 baud before shipment. Test cassette with 8080 software program included. This cassette was recorded and played back during quality control.

### COMING NEXT MONTH — IN KIT FORM

- \* Hexadecimal Keyboard — Load programs direct from keyboards' 16 keys and verifying display. Does not use Computer I/O.
- \* I/O for use with Computer Aid or other digital recorders. Variable baud rate selectable on externally located unit by one knob. Can load computer or accept dumps without software. Turnkey Operation. For any 8 bit computer.
- \* Record/Playback Amplifier  
Expanded version of our Computer Aid

board for use with your own desk (cassette or reel to reel). Go to 9600 baud on reel to reel. Digital in, digital out, serial format.

- \* Interested in these? Send your name and address for brochure when released.

(EDUCASSETTE is our registered TradeMark)

**Fill out form and send check or money order to:**  
**NATIONAL MULTIPLEX CORPORATION**  
3474 Rand Avenue, Box 288  
South Plainfield, New Jersey 07080

Mailing Label — PRINT

### NATIONAL MULTIPLEX CORPORATION

3474 Rand Avenue, Box 288  
South Plainfield, New Jersey 07080

SHIP TO:

.....  
.....  
.....

ZIP .....

..... Data Recorder @ \$149.95

..... Operating & Technical  
Manual (Schematics)  
@ \$1.00

\* ..... New Products, No Charge

Please enclose \$2.00  
Shipping & Handling  
N. J. Residents add 5%  
Sales Tax

# WHY WASTE WATTS?



**SWR-1 guards against power loss for \$21.95**

If you're not pumping out all the power you're paying for, our little SWR-1 combination power meter and SWR bridge will tell you so. You read forward and reflected power simultaneously, up to 1000 watts RF and 1:1 to infinity VSWR at 3.5 to 150 MHz.

Got it all tuned up? Keep it that way with SWR-1. You can leave it right in your antenna circuit.

**SWAN**<sup>®</sup>  
ELECTRONICS  
*A subsidiary of Cubic Corporation*

305 Airport Road, Oceanside, CA 92054  
(714) 757-7525

## KEYBOARD ENCODERS

AND

### "Customized" 2-Meter FM Transceiver



MIDLAND 13-500

12-digit Pad built-in  
\$299 --Limited Supply!



\$49.95

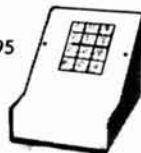

\$49.95

Enclosures with lighted pad; pre-wired.

Enclosure Only (either style) \$8.95

.....

**KING PRODUCTS SUB-MINIATURE KEYBOARD ENCODER -- COMPLETE WITH NEW MOTOROLA CHIP AND PC BOARD**

12-digit assem.

\$59.95



16-digit assem.

\$69.95



Dealer Inquiries Invited



All prices PREPAID shipping Cont'l USA

## KING PRODUCTS

Manufacturer & Distributor of Communications Equipment  
P. O. BOX A, LOMITA, CA 90717 • (213) 534-4402

computerized

**New for your TV!**

# PING PONG

Assemble your own electronic Ping Pong unit that connects to any TV. It's easy! Complete plans, p/c boards, kits, assembled boards. Our design includes up-down and in-out paddle motion, lob-spin-smash ball action, computer-control paddle, sound effects and optional on-screen scoring module.

Main p/c board (with all functions except on-screen scoring) includes a second game BUMPER with lots of rebound action and change of pace when BUMPER 'swallows' the ball.

Typical component cost including 18 TTL and 8 Cmos chips is \$40 plus p/c board. Send \$28.50 for main p/c board with aligned horizontal and vertical sync oscillators and plans .... or send \$1.00 (refundable) for info pack describing circuit functions, component line-up, kits, p/c boards, accessories, assembled boards.

**visulex**  
P.O. BOX 4204-H MOUNTAIN VIEW, CA 94040



# **KLM** BROADENS ITS **BIG STICK** LINE OF HIGH FREQUENCY ANTENNAS

## **4 ELEMENTS 40 METERS**

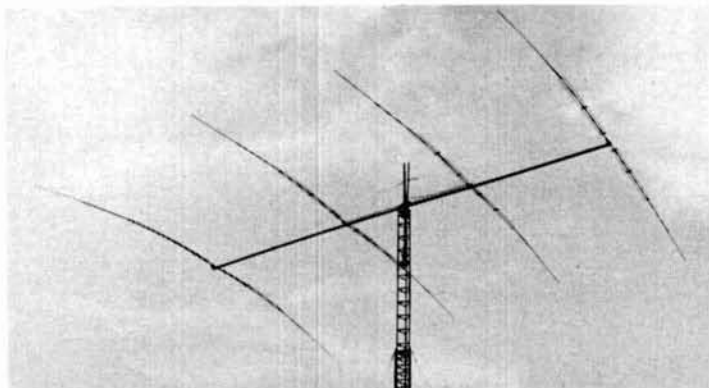

INTRODUCING THE LONG AWAITED, PRACTICAL SIZED, HIGH PERFORMANCE 40 METER "BIG STICK" DUAL DRIVEN YAGI. NOW YOU CAN HAVE **CONSTANT GAIN** AND **LOW VSWR** ACROSS THE 40 METER BAND. **DUAL DRIVEN ELEMENTS** FOR HIGH EFFICIENCY AND **CLEAN PATTERN**. **LIGHTWEIGHT** BUT **STRONG** MATERIALS INCLUDING KLM EXCLUSIVE EPOXY INSULATOR DESIGN . . .

### SPECIFICATIONS

FREQUENCY: 7.0-7.3 MHz  
ELEMENTS: 4, LINEAR LOADED  
46' MAX. LENGTH

BOOM: 3" DIA. X 42' LONG  
TURNING RADIUS: 32'

SHIPPING CONTAINER: WOOD CRATE 12' LONG  
125 LBS. TOTAL WEIGHT

GAIN: 7.25 dB/DIPOLE  
F/B: 20 dB TYPICAL

FEED IMP.: 200 OHMS BALANCED  
(50 OHMS WITH OPTIONAL  
KLM 5-31 4:1 BALUN — \$13.95)

WEIGHT: 85 LBS.  
WIND AREA: 10 SQ. FT.

**PRICE \$495.00**

**20 METER 5 ELEMENT**

**15 METER 6 ELEMENT**

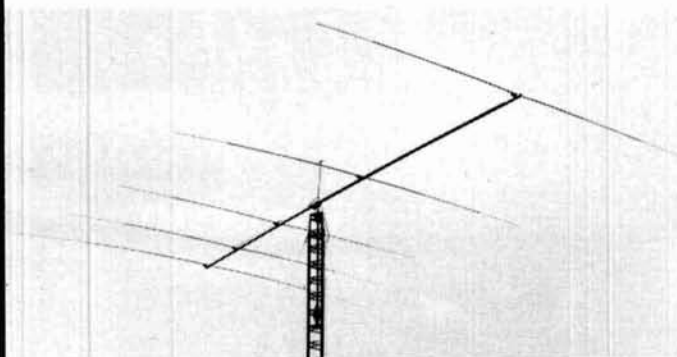

KLM 13.9-14.4-5 **\$249.95**  
9.7dB GAIN 30dB F/B

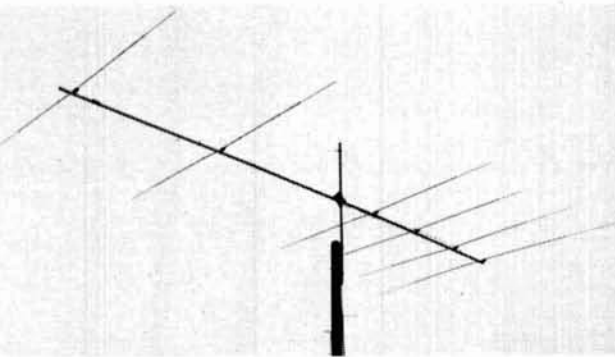

KLM 21.0-21.5-6 **\$224.95**  
10.5dB GAIN 30dB F/B

WHEN YOU SPEAK OF PERFORMANCE IN  
ANTENNAS, AMPLIFIERS OR TRANSCEIVERS THE NAME IS:

# **KLM** ELECTRONICS

17025 LAUREL ROAD  
MORGAN HILL, CA. 95037  
(408) 779-7363



# What you SEE IS ALL you carry.



Model 1920A

520 MHz ..... \$860\*



Model 1920A-13

1000 MHz .... \$1055\*



Model 1920A-14

1250 MHz ..... \$1155\*

## Fluke's newest portable counters.

- Built-in batteries (optional)
- Sharp 9-digit LED display
- Burst or CW frequency measurements
- Sensitivity to 15 mV; AGC standard
- Optional resolution multiplier provides 0.001 Hz resolution in 1 sec.

For data out today, dial our toll-free number, 800-426-0361.

\*Domestic U.S.A. Price

**John Fluke Mfg. Co., Ltd.**  
P.O. Box 1094, Station D  
Buffalo, N.Y. 14210  
Phone (716) 842-0311



# NEW!

## GLOW-IN-THE-DARK "TT" PADS

TEK SERIES  
(All .40" THICK)

CLUB DISCOUNT  
ON 10 OR MORE

SHIPPED  
FROM STOCK



TEK-125 1.58" x 2.08" \$57.50  
TEK-165 2.08" x 2.08" \$65.00



# ELECTROGRAFIX

P.O. BOX 869  
CHINO, CA 91710

GUARANTEED RF PROOF - WILL  
MODULATE ANY TRANSMITTER  
LED TONE & BATTERY  
INDICATOR . . .

ADJ. LEVEL CONTROL, 6-16 VDC  
@ 15 mA max.  
XTAL CONTROLLED DIGITAL CMOS  
SINGLE UNIT ABS CASE —  
FALSE TONE PROOF  
SCHEMATICS FOR 3 WIRE  
HOOKUP ON REQUEST  
SPECIFY POS OR NEG GROUND

(Quantity & OEM prices on application)

(714) 627-4287 - (714) 627-1753  
MONEY BACK GUARANTEE

SEND CHECK OR M.O. (CA RESIDENTS ADD 6% TAX) WITH MAKE & MODEL OF TRANSMITTER TO:

### MEMORIES

825129 1024 bit ROM(256x4 PROM) -access time 50 NS -Power dissipation .5 MW/BIT -Tri-state output -Field programmable -16 pin DIP	1702 2048 bit PROM -2K -ultra-violet light erasable -static units Each \$9.95
---	--

Each \$5.00 8 for \$34.95

### Voltage Regulators TO-3

1 AMP POSITIVE each 10 for

LM309K 5V	\$1.00	\$8.00
7806 6V	1.50	13.00
7812 12V	1.95	17.50
7815 15V	1.95	17.50
7824 24V	2.25	20.00

1 AMP NEGATIVE

LM320 5V	1.95	17.50
LM320 5.2V	1.95	17.50
LM320 12V	1.95	17.50
LM320 15V	1.95	17.50

2N3565 NPN TO-106  
30v Beta 150 mfn.  
500 mw.

Each \$.15  
10 pak \$1.00

1 CERAMIC DISC CAPACITORS  
8 for \$1.00

.01 CERAMIC DISC CAPACITORS  
15 for \$1.00

### DIP Trimmer

-12 turn trim pots which plug into a dip socket  
-5K and 200K  
- $\frac{1}{4}$ " x  $\frac{1}{4}$ " x  $\frac{1}{4}$ "  
-4 leads spaced .3" x .2"  
Each \$.65 10 for \$4.95

### TTL Special 270

Quad 2-input NAND gates DIP. Pin compatible w/ SN7400,  $\frac{1}{2}$  current drain  
Data supplied

270 Each \$.16  
10 for 1.40

### DIP RC NETWORKS

14 and 16 pin IC packages containing precision resistors and capacitors.  
NO SCHEMATICS AVAILABLE  
Sample indicates most contain 10 to 15R and 1 or 2C.  
Assortment of 15 \$1.00

All merchandise is new unused surplus and is sold on a money back guarantee. Five dollar minimum order. Free first class postage on all orders. California residents please add sales tax.

TX# 910-367-3521 Phone (916) 334-2161  
Mail orders to: P.O. Box 41778 Sacramento, CA 95841

**BABYLON ELECTRONICS**

SEND FOR  
FREE FLYER

MAKE PROFESSIONAL LOOKING PC BOARDS FAST AND EASY

**STAMP-IT ETCH-IT**

Reduces Printed Circuit Board Art Work From 2 Hours to 10 Min.

Simple as A.B.C.

A. Name Components on P.C. Board B. Use Pen to Connect Lines C. Etch Board

SE-2 KIT CONTAINS

- 1. 1/2" x 1/2" x 1/8" BOARD
- 2. 1/2" x 1/2" x 1/8" BOARD
- 3. 1/2" x 1/2" x 1/8" BOARD
- 4. 1/2" x 1/2" x 1/8" BOARD
- 5. 1/2" x 1/2" x 1/8" BOARD
- 6. 1/2" x 1/2" x 1/8" BOARD
- 7. 1/2" x 1/2" x 1/8" BOARD
- 8. 1/2" x 1/2" x 1/8" BOARD
- 9. 1/2" x 1/2" x 1/8" BOARD
- 10. 1/2" x 1/2" x 1/8" BOARD
- 11. 1/2" x 1/2" x 1/8" BOARD
- 12. 1/2" x 1/2" x 1/8" BOARD
- 13. 1/2" x 1/2" x 1/8" BOARD
- 14. 1/2" x 1/2" x 1/8" BOARD
- 15. 1/2" x 1/2" x 1/8" BOARD
- 16. 1/2" x 1/2" x 1/8" BOARD
- 17. 1/2" x 1/2" x 1/8" BOARD
- 18. 1/2" x 1/2" x 1/8" BOARD
- 19. 1/2" x 1/2" x 1/8" BOARD
- 20. 1/2" x 1/2" x 1/8" BOARD
- 21. 1/2" x 1/2" x 1/8" BOARD
- 22. 1/2" x 1/2" x 1/8" BOARD
- 23. 1/2" x 1/2" x 1/8" BOARD
- 24. 1/2" x 1/2" x 1/8" BOARD
- 25. 1/2" x 1/2" x 1/8" BOARD
- 26. 1/2" x 1/2" x 1/8" BOARD
- 27. 1/2" x 1/2" x 1/8" BOARD
- 28. 1/2" x 1/2" x 1/8" BOARD
- 29. 1/2" x 1/2" x 1/8" BOARD
- 30. 1/2" x 1/2" x 1/8" BOARD
- 31. 1/2" x 1/2" x 1/8" BOARD
- 32. 1/2" x 1/2" x 1/8" BOARD
- 33. 1/2" x 1/2" x 1/8" BOARD
- 34. 1/2" x 1/2" x 1/8" BOARD
- 35. 1/2" x 1/2" x 1/8" BOARD
- 36. 1/2" x 1/2" x 1/8" BOARD
- 37. 1/2" x 1/2" x 1/8" BOARD
- 38. 1/2" x 1/2" x 1/8" BOARD
- 39. 1/2" x 1/2" x 1/8" BOARD
- 40. 1/2" x 1/2" x 1/8" BOARD
- 41. 1/2" x 1/2" x 1/8" BOARD
- 42. 1/2" x 1/2" x 1/8" BOARD
- 43. 1/2" x 1/2" x 1/8" BOARD
- 44. 1/2" x 1/2" x 1/8" BOARD
- 45. 1/2" x 1/2" x 1/8" BOARD
- 46. 1/2" x 1/2" x 1/8" BOARD
- 47. 1/2" x 1/2" x 1/8" BOARD
- 48. 1/2" x 1/2" x 1/8" BOARD
- 49. 1/2" x 1/2" x 1/8" BOARD
- 50. 1/2" x 1/2" x 1/8" BOARD

ADDITIONAL STAMPS

- 1. 1/2" x 1/2" x 1/8" BOARD
- 2. 1/2" x 1/2" x 1/8" BOARD
- 3. 1/2" x 1/2" x 1/8" BOARD
- 4. 1/2" x 1/2" x 1/8" BOARD
- 5. 1/2" x 1/2" x 1/8" BOARD
- 6. 1/2" x 1/2" x 1/8" BOARD
- 7. 1/2" x 1/2" x 1/8" BOARD
- 8. 1/2" x 1/2" x 1/8" BOARD
- 9. 1/2" x 1/2" x 1/8" BOARD
- 10. 1/2" x 1/2" x 1/8" BOARD
- 11. 1/2" x 1/2" x 1/8" BOARD
- 12. 1/2" x 1/2" x 1/8" BOARD
- 13. 1/2" x 1/2" x 1/8" BOARD
- 14. 1/2" x 1/2" x 1/8" BOARD
- 15. 1/2" x 1/2" x 1/8" BOARD
- 16. 1/2" x 1/2" x 1/8" BOARD
- 17. 1/2" x 1/2" x 1/8" BOARD
- 18. 1/2" x 1/2" x 1/8" BOARD
- 19. 1/2" x 1/2" x 1/8" BOARD
- 20. 1/2" x 1/2" x 1/8" BOARD
- 21. 1/2" x 1/2" x 1/8" BOARD
- 22. 1/2" x 1/2" x 1/8" BOARD
- 23. 1/2" x 1/2" x 1/8" BOARD
- 24. 1/2" x 1/2" x 1/8" BOARD
- 25. 1/2" x 1/2" x 1/8" BOARD
- 26. 1/2" x 1/2" x 1/8" BOARD
- 27. 1/2" x 1/2" x 1/8" BOARD
- 28. 1/2" x 1/2" x 1/8" BOARD
- 29. 1/2" x 1/2" x 1/8" BOARD
- 30. 1/2" x 1/2" x 1/8" BOARD
- 31. 1/2" x 1/2" x 1/8" BOARD
- 32. 1/2" x 1/2" x 1/8" BOARD
- 33. 1/2" x 1/2" x 1/8" BOARD
- 34. 1/2" x 1/2" x 1/8" BOARD
- 35. 1/2" x 1/2" x 1/8" BOARD
- 36. 1/2" x 1/2" x 1/8" BOARD
- 37. 1/2" x 1/2" x 1/8" BOARD
- 38. 1/2" x 1/2" x 1/8" BOARD
- 39. 1/2" x 1/2" x 1/8" BOARD
- 40. 1/2" x 1/2" x 1/8" BOARD
- 41. 1/2" x 1/2" x 1/8" BOARD
- 42. 1/2" x 1/2" x 1/8" BOARD
- 43. 1/2" x 1/2" x 1/8" BOARD
- 44. 1/2" x 1/2" x 1/8" BOARD
- 45. 1/2" x 1/2" x 1/8" BOARD
- 46. 1/2" x 1/2" x 1/8" BOARD
- 47. 1/2" x 1/2" x 1/8" BOARD
- 48. 1/2" x 1/2" x 1/8" BOARD
- 49. 1/2" x 1/2" x 1/8" BOARD
- 50. 1/2" x 1/2" x 1/8" BOARD

ONLY \$9.95 PLUS 75¢ Postage & Handling

**M-TECH ENGINEERING, INC.**  
BOX C  
SPRINGFIELD, VIRGINIA 22151  
703/354-0573

## NOW — PROGRAMMABLE ELECTRONIC KEYS



COMPLETE KIT  
ONLY \$59.95 ppd.  
ASSEMBLED \$79.50 ppd.

FEATURES: Dot and Dash Memory, Two Independent 256 Bit Memories, Keys up to -150V, Self Completing Char. 6 to 60 WPM, Iambic Keying. Does not include paddle.

## NEW ENGLAND DIGITAL ELECTRONICS

BOX 684 KENMORE STATION  
BOSTON, MA. 02215

## WANT SOMETHING REALLY SMALL AND EFFICIENT?

Then you want the antenna that's known around the world for its small size and superior performance . . .  
The Mini-Products Multiband HYBRID QUAD

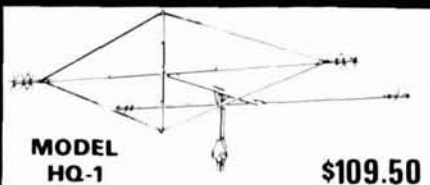

MODEL HQ-1 \$109.50

If not stocked by your dealer order direct. We pay shipping in USA. Send for free catalog of other models and more data.

- ELEMENT LENGTH - 11 ft.
- BOOM LENGTH - 54 INCHES
- WEIGHT - 15 POUNDS
- WIND SURVIVAL - 75 MPH
- BANDS COVERED - 6, 10, 15 & 20
- 1200 WATTS P.E.P.
- FEED LINE - 50 OHMS

**Mini-Products, Inc.**

1001 W 18th St. Erie, Pa. 16502

# YOUR SUPERMARKET OF AMATEUR VALUES



**NOW AVAILABLE!!**  
**1976 BUYERS GUIDE**  
 SEND FOR YOUR  
 FREE COPY NOW.  
 NO GENERAL MAILING WILL BE MADE

**YOU MADE US THE NATION'S FM LEADER . . .  
 NOW LET US HELP FILL ALL YOUR AMATEUR NEEDS**

- PERSONAL, FRIENDLY SERVICE
- PROMPT MAIL & PHONE SERVICE
- LIBERAL TRADE INS
- QUALITY BRANDS

**LOTS OF  
 MOTOROLA GOODIES  
 TOO!!**

**MOTOROLA FANS . . . NEW, SPECIAL GOODIES LIST FREE FOR S.A.S.E.**

**SEE YOU AT SAROC**



## SPECTRONICS, INC.

1009 GARFIELD  
 OAK PARK, IL. 60304  
 312-848-6778  
 TELEX 72:8310

## HOURS

STORE HOURS:  
 Mon-Thurs 9:30-6:00, Fri. 9:30-8:00  
 Sat. 9:30-3:00, Closed Sun. & Holidays.



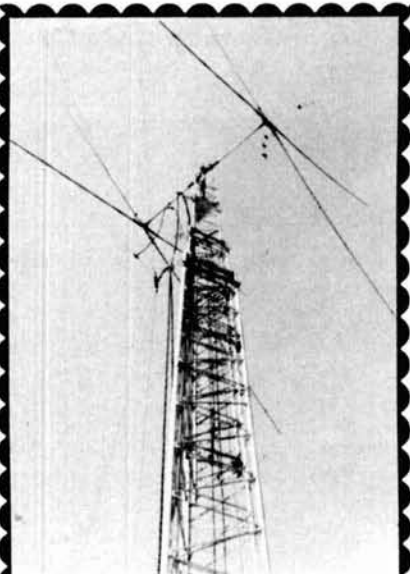

## The popular CUA 64-12 by Heights

Light,  
permanently  
beautiful  
**ALUMINUM**  
towers

**THE MOST IMPORTANT  
FEATURE OF  
YOUR ANTENNA  
IS PUTTING  
IT UP WHERE  
IT CAN DO  
WHAT YOU EXPECT.  
RELIABLE DX —  
SIGNALS EARLIEST IN  
AND LAST OUT.**

**ALUMINUM**  
Complete Telescoping  
and Fold-Over  
Series available  
Self-Supporting  
Easy to Assemble  
and Erect  
All towers mounted  
on hinged bases

And now, with motorized options, you can crank it up or down, or fold it over, from the operating position in the house.

Write for 12 page brochure giving dozens of combinations of height, weight and wind load.

**ALSO TOWERS FOR WINDMILLS**  
**HEIGHTS**  
**MANUFACTURING CO.**  
In Almont Heights Industrial Park  
Almont, Michigan 48003

# THIS IS YOUR BIG CHANCE!

**BUY \$50 WORTH; THEN PICK \$50 WORTH FREE!**

**OTHER ORDERS: \$10+ Orders take 5% Discount; \$30+ Orders take 10% Discount**

7400 SERIES						DM 8000			
7400 .17	7437 .45	7474 .45	74141 1.10	74177 .85	8090N .60	8230N 2.50	8830N 1.10	8831N 2.55	8832N 2.55
7401 .17	7438 .40	7475 .75	74151 1.25	74185 2.25	8092N .50	8470N .50	8833N 1.15	8833N 1.15	8835N 1.00
7402 .17	7439 .30	7476 .40	74153 1.45	74189 3.00	8095N .50	8520N 1.20	8836N .50	8837N 1.45	8853N .95
7403 .17	7440 .20	7483 1.10	74155 1.25	74190 1.50	8097N .50	8598N 4.90	8838N 1.95	8864N 1.95	8880N 1.35
7406 .45	7441 1.00	7492 .90	74157 1.40	74191 1.50	8123N 1.55	8599N 3.00	8839N 1.50	8895N 1.00	
7410 .20	7442 1.00	7493 .90	74161 1.60	74192 1.25	8130N 2.10	8612N 2.00			
7413 .75	7443 1.00	7496 .90	74162 1.45	74193 1.25	8210N 3.10	8613N .75			
7416 .45	7445 .95	74100 1.50	74163 2.40	74195 1.00	8211N 1.95	8640N .50			
7417 .45	7446 1.15	74107 .45	74164 2.40	74196 1.25	8212N 2.50	8796N 2.00			
7420 .20	7448 1.15	74122 .50	74170 2.90	74198 2.20	8214N 1.75	8810N .50			
7425 .35	7450 .25	74123 1.00	74173 1.70	74200 7.00	8220N 1.50	8811N .85			
7426 .30	7454 .35	74126 .75	74174 1.85		8223N 3.00	8812N .50			
7430 .25	7460 .25	74132 2.85	74175 1.85		8225N 2.50	8822N 2.60			
7432 .25	7472 .40				8T20 2.25				

## WEIRNU

PO Box 942, Colton, CA 92324

1. Add 50¢ for postage & handling on orders under \$10.
2. All items guaranteed.
3. Send SASE for Bargain Flyer.
4. SEND YOUR ORDER ALONG WITH CHECK OR MONEY ORDER TO: WEIRNU, P. O. Box 942, Colton, CA 92324 (Calif. residents include 6% tax).

## SSB...CW...FM...80-10...VHF...UHF



### PERSONALIZED SERVICE FOR ALL YOUR AMATEUR NEEDS

New Equipment	Used Equipment	FM Transceivers
Transmitters	Publications	Preamps
Receivers	OSCAR Antennas	Mobile Antennas
Keys	Coax	Beams



### SPECTRONICS INC.

1009 GARFIELD STREET  
OAK PARK, ILL. 60304  
(312) 848-6778



## test your skills on the "WHEEL OF FORTUNE"

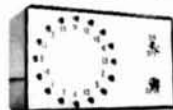

**COMPLETE KITS  
ONLY \$24.95**  
Prepaid

#### INCLUDES:

Phenolic Case • Engraved Front  
Drilled P.C. Board • All Necessary Components  
Detailed Instructions with Simulations

### HOSFELT ELECTRONICS

224 OPAL BOULEVARD  
STEUBENVILLE, OHIO 43952  
PHONE 614 264-6464

## NEW YEAR SPECIAL



THE BRIMSTONE 144



AUTOMATIC ELEC.  
PAD & ENCLOSURE

### STRETCH THOSE DOLLARS!

We'll team up a brand new Brimstone 144 with Touch-Tone\* Interface and Automatic Electric Pad & Enclosure, wired and ready to go ..... all for only \$710.00

Nye Viking and Ten-Tec equipment available.

Call or write for immediate assistance.

### COMMUNICATION SPECIALTIES INC.

97 AMSTERDAM AVENUE  
P. O. BOX 471 WARWICK, R. I. 02889  
©T.M. of A. T. & T. 401-738-3287

## FREE CATALOG

### HARD-TO-FIND PRECISION TOOLS

Lists more than 2500 items—pliers, tweezers, wire strippers, vacuum systems, relay tools, optical equipment, tool kits and cases. Also includes ten pages of useful "Tool Tips" to aid in tool selection.

### JENSEN TOOLS

4117 N. 44th Street, Phoenix, Ariz. 85018



## MILITARY SURPLUS WANTED

Space buys more and pays more. Highest prices ever on U.S. Military surplus, especially on Collins equipment or parts. We pay freight. Call collect now for our high offer. 201 440-8787.

### NEW ADDRESS

### SPACE ELECTRONICS CO.

div. of Military Electronics Corp.  
35 Ruta Court  
S. Hackensack, N.J. 07606

## NEW YEAR SPECIAL!

Complimentary issue of  
THE BIG LIST from  
Buyers & Sellers. Check off #329.

### BUYERS & SELLERS

P.O. Box 73  
Kenmore Station  
Boston, Mass. 02215 617-536-8777

# flea market



**RATES** Non-commercial ads 10¢ per word; commercial ads 40¢ per word both payable in advance. No cash discounts or agency commissions allowed.

**HAMFESTS** Sponsored by non-profit organizations receive one free Flea Market ad (subject to our editing). Repeat insertions of hamfest ads pay the non-commercial rate.

**COPY** No special layout or arrangements available. Material should be typewritten or clearly printed and must include full name and address. We reserve the right to reject unsuitable copy. Ham Radio can not check each advertiser and thus cannot be held responsible for claims made. Liability for correctness of material limited to corrected ad in next available issue.

**DEADLINE** 15th of second preceding month.

**SEND MATERIAL TO:** Flea Market, Ham Radio, Greenville, N. H. 03048.

**THE LARGEST SWAP AND SHOP IN MICHIGAN.** Southfield Amateur Radio Clubs, January 18, 1975, Southfield High School, Ten Mile and Lahser Rds., Southfield, MI. Tickets \$1.50. For more information regarding tickets and/or tables, write to Mr. Robert Younkers, 24675 Lahser Road, Southfield, Michigan 48075.

**SELL THE FOLLOWING:** Hallicrafters FPM300 Telerex 6 el beam, Winford Barnes, Box 28, Bunker Hill, In. 46914.

**WISCONSIN** — West Allis Radio Amateur Club annual Midwinter Swapfest, Saturday, January 24, 1976, 8 a.m. at the Waukesha County Expo Center. Directions: I-94 to Waukesha Co. F. south to FT, west to Expo Center. Talk-in 146.52 MHz. Tickets \$1.50 advanced, \$2.00 at door. (Dealers: advanced registration only.) Write: WARAC, P. O. Box 1072, Milwaukee, WI 53201.

**STOLEN** from Findlay Radio Club, Inc., club house in Findlay, Ohio, on Oct. 13 or Oct. 14 (it was on the nite or morn., 13 or 14 respectively 1975. 1 — TR-4, Serial No. 16457-A, Drake transceiver; 1 — AC-4, Serial No. 30557, Drake power supply; 1 — 250C, Serial No. E189109, Swan SSB transceiver; 1 — 117XC, Serial No. 015095, Swan power supply; 1 — Astatic D-104 microphone with UGB stand; 1 — FM-2X, Serial No. 11454, Swan transceiver with M-1002 microphone; 1 — FM-2X, Serial No. 11454, Swan matching supply; 1 — TV-2, Swan 6M to 2M transverter. Findlay Radio Club, Inc., P. O. Box 587, Findlay, Ohio 45840.

**FREE Catalog.** LEDs, microphones, nicads, IC's, relays, ultrasonic devices, precision trimmer capacitors, digital thermometers, unique components. Chaney's, Box 15431, Lakewood, Colo. 80215.

**BAZOOKA. DIPOLE** . . . Ready to use, with fiberglass center SO239, end insulator 80M, \$29.50, 40M, \$26.50, 20-15-10M, \$23.50 Fiberglass central insulator with SO239, 1000 pound test, \$5.95. Trap 2 KW 80/40, 40/20, \$18.50 ppd. 1000 pound test, JAC-TENNA, 13850 Victorin. Tracy, P. Que. Canada.

**ORIGINAL PETIT MORSE TO RTTY CONVERTER** Inventory Closeout. Manufacturer discontinued production. Fantastic price reductions — semi-kit \$95, parts kit \$255, assembled and tested \$380. Also Baudot to Morse (with 64 character buffer) \$135 and Baudot to ASCII (perfect for TV typewriter) \$59. SASE for details. Walters, Box 563, Oak Harbor, Wa. 98277.

**TRADE** — Single channel VHF receiver 108-152 MHz Ex-FAA crystal control squelch double conversion, want R390 or R389 or R648. Bob Bose, 6821 Sally Lane, Edina, MN 55435.

**WANTED:** Couple "ICEMAN" 2 meter FM transceivers, advise condition, price. Ed Aymond, W5UHV, 6730 Westlake, Dallas, TX 75214.

**SPECIAL DESIGNED P.C. BOARDS:** Will quote and build special boards per customers specifications. For complete information contact Wayne Camp, Camp Control Co., P. O. Box 174, Garland, Texas 75040.

**DX-60, HG-10, \$50 plus shipping.** SASE for other items. WB6PCV, Marty Bigos, 1926 Fell, S. F., Ca. 415-387-0409.

**TELEVISION** diagnostic repair course prepared by master technicians. Lessons only \$6.00 each. Optional matching one hour cassette tape \$6.00 each. Send for first lesson and master index. Guardian, 20 E. Main, Ramsey, N. J. 07446.

**CUYAHOGA FALLS** Amateur Radio Club Annual Auction and Flea Market. Date: February 27, 1976. Place: Bolich Jr. High - Cuyahoga Falls, Oh. Admission: \$1.50 advanced registration. Deadline Feb. 1, 1976. \$2.00 door night of auction. Talk-in frequency: 84/24-04/64-52/52. Call W8VPV. Advance Tickets: KBVAK & XYL, 3043 De Walt Dr., Akron, Oh 44312. 216-644-1213.

**HOME BREWERS:** Stamp brings list of high quality components. CPO Surplus, Box 189, Braintree, Mass. 02184.

**CANADIAN JUMBO SURPLUS** and Parts Catalogs. Bargains Galore. Send \$1. ETCO-HR, Box 741, Montreal "A" H3C 2V2.

**ROCHESTER HAMFEST 1976** is Saturday, May 22. Your name added to mailing list or information — write: Rochester Hamfest, Box 1388, Rochester, N. Y. 14603.

**PORTA-PAK** the accessory that makes your mobile really portable. \$59.95 and \$39.95. Dealer inquiries invited. P. O. Box 67, Somers, Wisc. 53171.

**WYOMING RANCH LAND.** Wild horses, antelope, deer, elk, 10 acres \$30 down, \$30 month. FREE Maps - Photos - Info. Owner - K6ICS, Mike Gauthier, 9550 Gallatin, Downey, CA. 90240.

**JAPANESE TRANSISTORS** — All Transistors original factory made. Over 500 types available. Write for free catalog. West Pacific Electronics, P. O. Box 25837, W. Los Angeles, CA 90025.

**TRAVEL-PAK QSL KIT** — Send call and 25¢; receive your call sample kit in return. Samco, Box 203, Wynantskill, N. Y. 12198.

**VERY in-ter-est-ing!** Next 4 big issues \$1. "The Ham Trader," Sycamore, IL 60178.

**MODERN 60 MIN. CODE CASSETTES.** Novice 0-5 wpm, Progressive 5-13 wpm, General 13-15 wpm, Extra 20-22 wpm. \$3 each, 4/\$10. Royal, Box 2174, Sandusky, Ohio 44870.

**QRP TRANSMATCH** for HW7, Ten-Tec, and others. Send stamp for details to Peter Meacham Associates, 19 Loretta Road, Waltham, Mass. 02154.

**SOCIETY OF WIRELESS PIONEERS** offers Life Membership to active and former C.W. operators on comm'l., military, gov't., etc. wireless/radio circuits. Contact: Society of Wireless Pioneers, Dept. H, P. O. Box 530, Santa Rosa, California 95402.

**PC's,** Send large S.A.S.E. for list. Semtronics, Rt. #3, Box 1, Bellaire, Ohio 43906.

**OSCAR SLIDES,** set of 5, \$1.25. Launch and spacecraft. Proceeds AMSAT. K6PGX, P. O. Box 463, Pasadena, CA 91102.

**RECONDITIONED TEST EQUIPMENT** for sale. Catalog \$50. Walter, 2697 Nickel, San Pablo, Ca. 94806.

**OSL'S — BROWNIE W3CJ1** — 3035B Lehigh, Allentown, Pa. 18103. Samples with cut catalog 35¢.

**MOBILE IGNITION SHIELDING** provides more range with no noise. Available most engines in assembled or kit forms, plus many other suppression accessories. Free literature. Estes Engineering, 930 Marine Dr., Port Angeles, WA. 98362.

**WANTED:** R-390A parts. W6ME, 4178 Chasin Street, Oceanside, Ca. 92054.

**NEW CANADIAN MAGAZINE.** "Electronics Work Shop" \$5.00 yearly, sample \$1.00. ETCOB, Box 741, Montreal, H3C 2V2.

**TELL YOUR FRIENDS** about Ham Radio Magazine.

**COMPUTER HOBBYISTS!** Bargain hunt or sell via On-Line. 18 issues/year - \$3.75. Free sample issue from: On-Line, 24695 Santa Cruz Hwy., Los Gatos, CA 95030.

**"HAM BUY LINES"** Send name and address for Literature. Vito Iacopelli, 1720 77 St., Brooklyn, New York 11214.

**DO-IT-URSELF DXPELITION** — Stay at ZF15B — Cayman Is. Vertical antenna and Caribbean at your doorstep. Diving/fishing if band folds. Write Spanish Bay Reef Resort, Box 800K, Grand Cayman, B. W. I.

**FERRITE BEADS:** Ferroxcube beads w/specification and application sheet — 10 @ \$1.00 postpaid. Includes latest catalog. CJO Surplus, Box 189, Braintree, Mass. 02184.

**COLLINS:** 30S-1 in excellent operating and physical condx for Bendix R-1051B/E receiver. Sid Sidman, 3571 Gresham Court, Pleasanton, Calif. 94566.

**ENGRAVED RADIO LICENSE.** Exact reproduction in solid brass. Permanent identification. Send good Xerox copy, with \$5.00, to Metal Art Graphics, 1136 Potomac Ave., Hagerstown, Md. 21740.

**FIGHT TVI** with the RSO Low Pass Filter. For brochure write: Taylor Communications Manufacturing Company, Box 126, Agincourt, Ontario, Canada. MIS 3B4.

**TELETYPE EQUIPMENT FOR SALE** for beginners and experienced operators. RTTY machines, parts, supplies. Special beginners package consists of Model 15 page printer and TH5-TG demodulator, \$125.00. Atlantic Surplus Sales, 3730 Nautilus Ave., Brooklyn, N. Y. 11224. Tel: (212) 372-0349.

**MICRO-TO MK II** deluxe epoxy-glass drilled circuit boards. \$4.00 postpaid; with semicons \$11.80. K3CUW, 1304B Mass. Ave. S.E., Washington, D. C. 20003.

**WANTED:** tubes, transistors, equipment, what have you? Bernard Goldstein, W2MNP, Box 257, Canal Station, New York, N. Y. 10013.

**QSL CARDS** — Something completely different. Nothing even close to it on the market! Samples: 25¢. W5UTT, Box 1171D, Garland, TX 75040.

**SELL:** Drake ML-2, 2M FM. Absolute mint condx! Xtals for 9 channels. Complete - \$219. WA3CUQ, 337 E. Main St., Kutztown, Pa. 19530.

**TROPICAL HAMBOREE** — Miami, Florida — January 24-25. The really international hamfest in a genuinely international city. Meet your island and Latin American DX friends in the only part of the USA — including most of Florida — with a 99 percent promise of January tropical sunshine. Hamboree traditional goodies plus — it's traditional! — always something new. The latest from the manufacturers — the not so late in the giant indoor flea market! At the ARRL forum, January Board Meeting results. Bicentennial QSO/QSL contest, sponsored by City of Miami, announcement and kick-off by Miami officials. Keep up with the state of the art at "Skip" Tenney's renowned microprocessor seminar (details from Skip at Ham Radio Magazine). For the lucky, an Atlas 210X, Heath HW104, Heath 2026, and an ICOM 230 plus much more. The YL's list includes a beautiful diamond ring! Registration \$2.00. Hotel data on request. Dade Radio Club, P. O. Box 520073, Miami, FL 33152.

**TELETYPEWRITER PARTS,** gears, manuals, supplies, tape, toroids. SASE list. Typetronics, Box 8873, Ft. Lauderdale, FL 33310. Buy parts, late machines.

**MANSFIELD, OHIO MID-WINTER HAMFEST/AUCTION** — new day and location. Sunday, February 1, 1976, at Richland County Fairgrounds. Forums, indoor flea market, displays, door prizes, and auction; easy access from I71 and U.S. 30. Registration \$1.50 in advance, \$2.00 at the door. Tables for flea market \$1.00 each. Doors open at 9 a.m., auction at 2:00. No commission charged. Talk in 3,972.5 kHz, 146.52 and 146.34/94 MHz. Additional info from K8JPF, Harry Fritchen Jr., 120 Homewood Rd., Mansfield, OH 44906. (419) 529-2801 home; (419) 524-1441 work.

**STOLEN** Regency HR-212 transceiver with microphone and mobile bracket, serial 24-00521; a Vanguard Labs model 201 pre-amp, attached to the back of the HR-212, and a Collins radio logbook. Stolen from my car at Aurora College, Aurora, Ill., on Nov. 13. Randy Thompson, 842 Shagbark Lane, Apt. 302, North Aurora, IL 60542.

**FT-101 #130153,** w/mods and Shure 444, \$525; HW-101 and HBPS, \$250; SB220 10HRS, \$350; HR-2A and GLB 400B, \$275; 1B-1100, \$125. Call collect 501-843-7602, Glen, WB4ZNV 522 E. Main St. #3, Cabot, Ark. 72023.

**NEW NEW NEW**

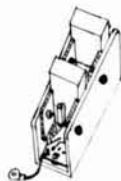

Transistor and Relay Assembly — consists of (2) MJE3055 and (2) MJE2955 transistors (10 amp, 90w, 60v complementary pairs) mounted in "U" channel heat sink 2 1/2" x 1 1/2" x 1 1/2". (2) XTAL CAN RELAYS, (DPDT, 28v, 8000Ω, 5.8 ma DC, 1 amp contacts mounted on PC board with resistors. \$2.85 ea. ppd.

UNPOTTED TOROIDS — All toroids are center tapped, 88MHY

Price is a low 5 for \$2.75 ppd.



1 1/4 inch miniature alligator clips. Bright vinyl red or black insulator. Nickel plated. 9 for \$1.00

NEW SIZES — VERTICAL MOUNT PC BOARD POTENTIOMETERS

American made (CRL) high quality pots. Available in the following sizes: 750 ohms, 1500 ohms, 25,000 ohms, 50,000 ohms, 100,000 ohms.

Price is 5 for \$1.10 ppd.

Transformer — American Made — Fully shielded. 115 V Primary. Sec. — 24-0-24 @ 1 amp with tap at 6.3 volt for pilot light.

Price — A low \$3.15 each ppd.

CRL DISC CAPACITORS

.1 MFD, 10V 3/8" dia., long leads.

10 for \$1.00 ppd.

NEW NEW NEW

Sperry SP-332 contains two 7 segment readouts, .330 high, side by side layout, black glass face, orange characters with decimal. 3/4 in. square. W/specs.



\$3.50 each, 3 for \$10.00

IDEAL FOR 2M POWER — Transformer 115 VAC primary, 18 volt, 5 amp ccs or 7 amp intermittent duty secondary.

\$6.60 ea. ppd.

MINIATURE SNAP ACTION SWITCHES —

SPDT leaf actuator, 10A, 125v AC, 1 1/2" x 1 1/2" x 3/8" 60¢ ea. or 3 for \$1.55

SPST N.O. Cherry "Button Type" E34, 15A, 125v AC, 1 1/2" x 3/8" x 3/8" 50¢ ea. or 3 for \$1.35

SPST N.C. Acro "Button Type" (tab accessible to make SPDT), 1 1/2" x 3/8" x 3/8" 50¢ ea. or 3 for \$1.35

BACK IN STOCK ONCE AGAIN!



3000 MFD @ 30 Volt Capacitors.

Size 1" Diameter x 3" Long. 90¢ Each or 3 For \$2.25 ppd.

SPST SLIDE SWITCHES (Red) Made by Stackpole — 4A, 125V A.C. 25¢ ea. ppd.

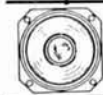

3 inch 4 ohm VC Square frame speaker 0.3 watt with 4 mounting holes.

\$1.35 each ppd.

PIONEER — 2 3/4" dia. Round Speaker, 7/8" deep, 16Ω, 0.3 watt. \$1.45 ea. ppd.

OVAL SPEAKER, 2" x 4" x 1 1/4" deep, 8Ω, 0.3 watt, anodized with 4 mtg. holes. \$1.65 ea. ppd.

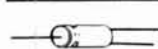

AMERICAN MADE

DUAL Electrolytic 1000 & 500 MFD. 15V, long leads. 3/4" dia. x 2 1/4" long.

55¢ each 3/\$1.50 ppd.

14 Wire, color coded, #22 ribbon wire. Qty limited 20¢/ft. or 10'/\$1.25

SEND STAMP FOR BARGIN LIST

Pa. residents add 6% State sales tax ALL ITEMS PPD. USA

Canadian orders for less than \$5.00 add \$1.00 to cover additional mailing costs.

**m. weinschenker**  
electronic specialties-BOX 353, IRWIN, PA 15642

**WHY USE LESS THAN THE BEST?**

The Quality designed and built into this M-Tech Amplifier allows us to include our famous ONE YEAR WARRANTY!



MODEL P50AI

Mode: Class C for CW and FM  
DC Input: +13.6 V DC @ 8 amps for rated output

RF Input: 1-3 watts 140-165 MHz  
RF Output: 40-60 watts 140-165 MHz  
Load Sensitivity: internally protected for any VSWR

Connectors: low loss 50Ω BNC  
COR switching w/LED indicator  
Spurious output filter  
Unique Low frequency negative feedback circuit

Send SASE for info - add'l models

**\$139.00** ppd. continental USA

ORDER TODAY FROM:

**M-Tech Engineering, Inc.**

BOX C, SPRINGFIELD, VA 22151  
(703) 354-0573

M-TECH... The Quality Company

**2 METER CRYSTALS IN STOCK**

FOR THESE RADIOS ON STANDARD ARRL REPEATER FREQUENCIES:

- DRAKE — TR-22
- GENAVE
- ICOM/VHF ENGINEERING
- KEN/WILSON
- REGENCY HR-2A/HR-212
- HEATHKIT HW-202
- REGENCY HR-2B
- S.B.E.
- STANDARD 146/826
- STANDARD HORIZON

Send for free frequency list and order blank to:

**KENSCO COMMUNICATIONS INC.**

DEPT. 101

BOX 469, QUINCY, MA. 02169

PHONE: (617) 471-6427



**SUB-AUDIBLE GENERATOR for FM**

THE CUBE

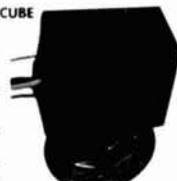

.5 x .6 x .8 in.

- Inexpensive multi tone system
- Compatible with PL-CG-QC
- Low distortion sine-wave
- Adjustable frequency (98-250 Hz), Lower available
- Rugged, plastic encased with leads, easy to mount
- Input 8-18 VDC unregulated
- Excellent stability

Lyle Products  
P.O. Box 2083  
Santa Clara Calif.  
95051

Price \$19.95

Calif. res. add 6%

Freq. set at factory \$5.00 extra

Send for more information

**Govt. SURPLUS ELECTRONIC EQUIPMENT CATALOG**

New ITEMS . . . New BARGAINS!

**FREE UPON REQUEST!**

If you haven't received our new Catalog, write for free copy today. Address: Dept. HR

**FAIR RADIO SALES**  
1016 E. EUREKA • Box 1105 • LIMA, OHIO • 45802

**DUPLEXER KITS**

PROVEN DESIGN. HUNDREDS SOLD IN US, CANADA, EUROPE. CONSTRUCTION WELDED ALUMINUM IRIDITE & SILVER PLATED. SEE JAN. 74 QST RECENT EQUIPMENT. ALL PARTS PROFESSIONAL QUALITY. EVERYTHING SUPPLIED. NO SPECIAL TOOLS. RECEIVER & TRANSMITTER CAN BE USED FOR TUNE UP.

MOD. 62-1 6 CAVITY 135-165 MHz POWER 250W ISOLATION GREATER THAN 100 dB 600 kHz. INSERTION LOSS .9 dB MIN. TEMP STABLE OVER WIDE RANGE **PRICE \$349.00**

MOD. 42-1 4 CAVITY SAME AS 6 CAVITY EXCEPT ISOLATION GREATER THAN 80 dB 600 kHz INSERTION LOSS .6 dB MAX. **PRICE \$249.00**

**NORTH SHORE RF TECHNOLOGY**

Exclusive Distributor **TUFTS Radio**  
386 MAIN ST., MEDFORD, MA 02155  
617-395-8280



Isolated - Pad - Drill - Mill  
Duplicate any etched board without etching. Professional - Compact - Usable Bread Boards

Sizes: 20, 15, 10 in. dia. - \$7.95 ea.,

See: 73, Nov., 73, p-19

QST, May, 73, p-14, Dec., 73, p-14

Hints & Kinks, p-82

**A F STAHLER Co**  
P.O. Box 354, Cupertino, CA. 95014

408-252-4219

**BRAND NEW CARTRIVISION COLOR VIDEO RECORDER-REPRODUCER ELECTRONIC UNIT.** Contains power supply with adjustable, regulated outputs of  $\pm 10$  to  $\pm 18$  VDC. ( $\pm 15$  VDC @ 1 1/2 amps) Third output is 10 VDC at 3 amps. Perfect for CMOS, TTL, Op-Amps and MICROPROCESSORS. Contains over 900 parts with extremely long leads. Includes 182 transistors, IC's, diodes, and FET's, numerous resistors, capacitors, crystals, inductors, varicaps and delay lines. (One 63.5 microsecond, precision, quartz, acoustically coupled delay line which stores one line of TV.) Transistors will operate in HEATHKIT TV's. Schematics and semiconductor cross reference supplied upon request. \$19.95 + \$1.50 shipping. 50¢ for brochure. Madison Electronics Company, Inc., P. O. Box 369, Madison, Alabama 35758. Money back guarantee.

**DESOLDERING AIDS AND HAND TOOLS.** R. L. Syphers Associates, Box 883, Dept. H, Bensenville, Illinois 60106.

**TELETYPES:** Model 19, \$175. Model 15, \$75. 516-581-6509, Al Shapiro.

**EXCLUSIVELY HAM TELETYPE** 21st year, RTTY Journal, articles, news, DX, VHF, classified ads. Sample 35¢. \$3.50 per year. Box 837, Royal Oak, Michigan 48068.

**MICHIGAN CHERRYLAND AMATEUR RADIO CLUB** annual Swap 'N Shop, Saturday, 14 February 1976. 9:00 a.m. to 4:00 p.m. at the Northwestern Michigan College campus in Traverse City. Talk-in will be 146.52 and 3935. Door prizes. Donation is \$1.00. For information contact Bill Mader, WA8WWM, Box 2, Empire A.F.S., Mi. 49630.

**FOR SALE:** SB-100 with HP23A, \$275; SB220, \$350; 18AVT/WB, \$40; DX-60B with VF-1 VFO, \$40; HR-10B, \$40. Wanted used tower, tri-band beam, ham-m rotator. John Merrill, WA1LZV, 8 Spruce Drive, Dover, N. H. 03820.

**ANTENNAS:** Dipole, multiple band arrays. 15 thru 75 meters from \$59.50. Mobile Antennas — CB, 20M, 40M, and 2M from \$19.50. Baluns: 1:1 and 4:1 - \$12.95 ea. Data Available. Savoy Electronics, Inc., P. O. Box 5727, Ft. Lauderdale, Fla. 33310.

**TELETYPE MODEL 28:** 28RO bases, \$35.00, 3/\$100.00. New Ribbons, \$1.50. Typeboxes (WX, COMM, or Fractions) \$25.00 ea. ASR base for LXD TD, \$25.00. Base - LXD stand-alone, \$30.00. M28 cabinets, gears, gearshifts, reperfs, TD's, keyboards, terminal units, paper, tape, ASR's, KSR's, SASE for complete list. L. Pfeiffer, 532 W. Wilson St., #1, Madison, WI 53703.

**OSCAR 7, SSB-CW TRANSMIT CONVERTERS.** For 28 or 50 MHz input at 20 mw. 432 MHz output at 1 watt. Solid state, for 12 volt supply. 35 watt solid state amplifier available for this converter. Units designed and built by W0ENC. Write for information. UHF-VHF Communications, 53 St. Andrew, Rapid City, S. D. 57701.

**TTL 7400N** 6/\$1.00, 7402 5/\$1.00, 7406 \$43 each, 7450N & 7453N 4/\$1.00, 74121 2/\$1.00, 75453 Peripheral Drivers 3/\$1.00, 1000V 1 amp diodes 10/\$1.00, 14 pin IC sockets 5/\$1.00, 18 pin edge connectors 2/\$1.00. National CMOS Data Book \$1.00 each. Free Catalog. Some quantities limited, all products guaranteed. NuData Electronics, 104 N. Emerson St., Mt. Prospect, IL 60056.

**WHEATON HAMFEST** — The Wheaton Community Radio Amateurs mid-winter hamfest is Sunday, February 8, at the DuPage County Fairgrounds, Wheaton, Illinois (Manchester Road, near County Farm Road), 8 a.m. to 5 p.m. Tickets \$1.50 advance, \$2.00 at the door. For advance tickets send \$1.50 each and a self-addressed stamped envelope to L. O. Shaw, W9OKI, 433 S. Villa Avenue, Villa Park, Illinois 60181. Advance tickets postmarked no later than February 1.

**FOR SALE:** FPM300 mint condition. Ceramic mike \$500 or best offer. Call 617-468-3926.

**BUY — SELL — TRADE.** Write for free mailer. Give name, address, call letters. Complete stock of major brands. New and reconditioned equipment. Call us for best deals. We buy Collins, Drake, Swan, etc. SSB & FM. Associated Radio, 8012 Conser, Overland Park, Ks. 66204. 913-381-5901.

**INDIANA — THE FIRST HAMFEST OF 1976,** the Fort Wayne Hamfest, is January 18, 1976, at Shiloh Hall, one-half mile west of Indiana 3 on the Carroll Road. More tables and space than last year. Flea market, food, drinks. Tickets are \$1.50 at the door. XYL's and children under 12 free. Tables available at \$1.00 for 4 feet. Talk-in on 28-8 and 16-76. Everyone welcome to start off 1976 with a bang! Write to the AC-ARTS, Inc., P. O. Box 342, Fort Wayne, IN 46801 for details.

**WANTED:** Cabinet for 51J-4 Collins. KP4BJM. 1713 Gardenia St., San Fco., Rio Piedras, P. R. 00927.

## THE BEST WAY TO MONITOR RADIO CHANNELS WITHOUT LISTENING

### TOUCH-TONE DECODER \$75.00

HURRY! ONLY 50 UNITS REMAINING!  
LOWEST PRICE EVER OFFERED  
FOR A QUALITY TOUCH-TONE DECODER



**MAYNARD ELECTRONICS** recently purchased the entire stock of discontinued models of **PLL TOUCH-TONE DECODERS** from a major commercial manufacturer. Our agreement stipulates that the sale of these units will be limited to the amateur radio market. Because the sale price is below the manufacturer's cost, it is necessary to limit sales to five units per ham to prevent commercial speculation.

#### FEATURES:

- Virtually immune to falsing by voice, CTCSS tones, music and noise.
- Includes a CALL LIGHT and BUZZER
- Output for vehicle HORN connection
- Relay UNMUTES SPEAKER when call is received
- Field programmable for UP TO EIGHT DIGIT code sequence
- May be used for MOBILE or FIXED
- Designed for 12 VOLTS DC Pos. or Neg. operation
- Dimensions: 1 1/4 x 4 3/4 x 5 15/16 inches

Units are brand new. Complete satisfaction is guaranteed. If for any reason you are not completely satisfied, just return the undamaged unit within ten days for refund.

**MODEL 2000B TOUCH-TONE DECODER AND MANUAL** ..... \$75.00  
**MATING CABLE. MULTI-CONDUCTOR CABLE WITH MOLEX CONNECTOR** ..... \$10.00

Please enclose check or money order for the total amount plus \$5.00 for shipping and handling. A \$10.00 deposit is required on C.O.D. shipments. F.O.B. Belmont.

Include your name, shipping address, zip code and ham call sign. Calif. residents add sales tax.

## MAYNARD ELECTRONICS COMPANY

P. O. Box 363, Dept. A • Belmont, Ca. 94002  
Phone (415) 592-1553

Touch-Tone is a reg. T.M. of AT&T Co.

### VHF/UHF CONVERTERS PREAMPS

Ten meters through 432 MHz. A post card will bring our full 1976 Catalog.

**JANEL laboratories**  
260 NW POLK AVE.  
CORVALLIS, OREGON 97330  
Telephone: 503-757-1134

### DIPOLE ANTENNA CONNECTOR

**HYE-QUE (HQ-1)** dipole connector has coax SO-239 socket molded into glass filled plastic body to accept coax PL-259 plug on feedline. Drip-cap keeps coax fittings dry. Instructions included. Guaranteed. At your dealers or \$3.95 postpaid. Comparison insulators 2/\$.99.

**BUDWIG MFG. Co.** PO Box 97H, Ramona, CA 92065

### Your BEST BUY in KITS

Freq. Counter Kit - 0-300 MHz ..... \$99.00

Freq. Counter Kit - 0-500 MHz ..... \$139.00

Basic Clock Kit - full 6 digit ..... \$17.95

Electronic Dice Game Kit ..... \$10.95

Function Generator Kit ..... \$10.95

Op-Amp Designer's Unit coming soon!

Also DVM available shortly. Various other kits and electronic components available. Send SASE for flyer.

### HAL-TRONIX

P. O. BOX 1101  
SOUTHGATE, MICH. 48195  
(313) 285-1782

## NEW from NRI Home training in AMATEUR RADIO

NRI, leader in Communications, Television, Electronics and TV-Radio home training, now offers the first in Amateur Radio courses, designed to prepare you for the FCC Amateur License you want or need.

### Don't lose your favorite frequency

The FCC has said "either-or" on licensing, but to pass Advanced and Extra Class exams, you need the technical guidance as offered by NRI. NRI Advanced Amateur Radio is for the ham who already has a General, Conditional or Tech Class ticket. Basic Amateur Radio is for the beginner and includes transmitter, 3-band receiver, code practice equipment. Three training plans offered. Get all the facts. Mail coupon. No obligation. No salesman will call on you. NATIONAL RADIO INSTITUTE, Washington, D.C. 20016.



**MAIL NOW**

NATIONAL RADIO INSTITUTE 46-016  
Washington, D.C. 20016  
Please send me information on Amateur Radio training.

Name \_\_\_\_\_ Age \_\_\_\_\_  
Address \_\_\_\_\_  
City \_\_\_\_\_ State \_\_\_\_\_ Zip \_\_\_\_\_

ACCREDITED MEMBER NATIONAL HOME STUDY COUNCIL

## WANTED WANTED YOUR CLEAN DRAKE TRADE-INS

WILL ALLOW IN TRADE FOR YOUR DRAKE . . .

TR-3/AC-3/MS-3 .....	\$350.00
TR-4/AC-4/MS-4 BELOW S/N 31320 .....	\$400.00
TR-4/AC-4/MS-4 ABOVE 31320 .....	\$450.00
TR-4C/AC-4/MS-4 .....	\$600.00
TR-6/AC-4/MS-4 SIX METER .....	\$500.00
TR-4 NOISE BLANKER .....	\$ 50.00
DC-3 OR DC-4 MOBILE P/S .....	\$ 50.00
RV-3, RV-4, RV-4C VFO .....	\$ 65.00
R-4A RECEIVER .....	\$200.00
R-4B RECEIVER .....	\$300.00
R-4C RECEIVER .....	\$425.00
T-4XB TRANSMITTER WITH AC-4 P/S .....	\$350.00
T-4XC TRANSMITTER WITH AC-4 P/S .....	\$375.00
2B OR 2C RECEIVER .....	\$150.00

ABOVE DRAKE TRADE-IN ALLOWED TOWARD ANY NEW-BOXED LATEST MODEL ATLAS, DRAKE, COLLINS, SWAN EQUIPMENT. WE PAY SHIPPING ON ALL NEW EQUIPMENT TO YOU U.P.S. SHIP YOUR TRADE-IN PREPAID TO US VIA U.P.S. TELL US WHAT YOU WANT. WRITE OR PHONE BILL SLEP (704) 524-7519.

**SLEP ELECTRONICS CO.**  
P. O. BOX 100, HIGHWAY 441, DEPT. HR  
OTTO, NORTH CAROLINA 28763

## FOR BETTER SERVICE TO YOU . . .

OPEN EVERY NIGHT UNTIL 9:00 P.M.!

Our way of giving you the very best in service is longer hours and more equipment.

Drake is the newest line to be signed on board. Whether you're a Novice or an Extra Class a visit to our store should be a must on your list.

### NEW ENGLAND'S HAM HEADQUARTERS Sells & Services:



Our large inventory also includes kits, amateur radio publications and the largest selection of used equipment in the Boston area.

Our business is devoted entirely to Amateur Radio!

# TUFTS RADIO ELECTRONICS

386 MAIN ST.  
MEDFORD, MASS. 02155

### APOLLO "SHADOW BOX ENCLOSURES"

are fabricated of heavy, cold rolled steel. The front panels are of 20-gauge brushed chrome steel; some models are line screened and have a red Rocker DPDT switch installed with gold plated contacts and terminals. Covers are baked on Wrinkle enamel.

All cabinets are completely assembled and supplied with four rubber feet riveted in. Individually packed in a heavy-duty, corrugated mailer carton.

Chassis C thru M are CRS, nickel-plated over copper for excellent RF conductivity.

PRODUCTION CABINETS TO YOUR SPECIFICATIONS ON SPECIAL QUOTATION; 250 PIECE MINIMUM. WRITE FOR QUOTATION.

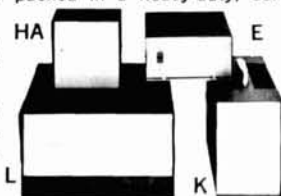

MODEL	WIDTH-HEIGHT-DEPTH	RESALE NET
A	5-1/2 x 2-1/2 x 3	4.25
AA*	4 x 3-7/16 x 3-1/4	5.50
B	5-11/16 x 3-3/8 x 3-3/8	5.55
BB*	9 x 2-1/2 x 3-1/4	5.90
C	7-1/4 x 3-3/8 x 5	7.80
D	8 x 2-1/2 x 8**	9.85
E	6-1/2 x 3-15/32 x 7-1/16	9.25
F	7-1/2 x 4-1/2 x 10	11.15
G	10-1/16 x 3-5/16 x 9	11.15
HA	5-1/4 x 5-1/2 x 4	7.85
D1	Mtg. bracket set for D	.40
J	5 x 3-1/2 x 5-1/4	8.35
K	4-3/4 x 7-3/8 x 11	15.00
L	11-1/4 x 6-1/4 x 12-1/4	22.95
M	11-1/4 x 6-1/4 x 16-1/4	24.40
NA	12-1/4 x 5-7/8 x 12-1/16	23.80

\*.050 aluminum cover & chassis w/grained panel  
\*\*Mobil mounting available.



"L"

package enclosure "Shadow Box" machined with: 2-S0239, 1-Pilot Light, 3 Rocker Switches, and 2-Knobs

pkg. \$33.00

## APOLLO PRODUCTS by "Village Twig"

BOX 245 • VAUGHNSVILLE, OHIO 45893 • Phone (419) 646-3495 • Evening Phone (419) 646-3495



NEW SSB & CW FILTER

The NEW DE-103A CW/SSB filter virtually eliminates QRM & QRN on both CW & SSB. Features include 100 hz CW filters, 1500 hz SSB filters, 3 watt audio amp., and built in AC supply. \$59.95. Other CW & SSB filters available.



INCREASE YOUR TALK POWER 10 TIMES

Our NEW DE-120 compressor easily gives 10 dB or more of speech compression without distortion allowing you to cut through QRM & QRN. Features include voice tailored response for added punch and solid state switching for long battery life. Requires two 9V batteries (Not included) \$59.95.

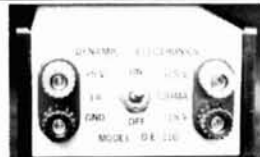

NEW POWER SUPPLIES

The NEW DE-110 digital and linear integrated circuit supply has outputs of +15 V at 100 ma, -15 V at 100 ma, and 5 V at 1 A. \$59.95.

One year warranty and 15 day return privilege. Add \$2 per order for shipping and handling. Other equipment is available. Write for new catalog.

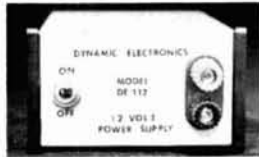

The NEW DE-112 regulated supply has an output of 12 VDC at 1 A for solid state equipment. \$24.95.

1/2 and 1/4 watt 5% RESISTORS  
Values from 10 ohm through 1 Meg in multiples of 10, 12, 15, 18, 22, 27, 33, 39, 47, 56, 68, & 82. 4¢ each, 5¢ per value, \$5 min. ppd. Quantity discounts & assortments are available.

**Dynamic Electronics, Inc.** P. O. Box 1131 Decatur, AL 35601



**YOUR CALL SIGN CUSTOM ROUTED** into natural 5/8" x 5 1/2" x 20" redwood. Choice black or white lettering. One side \$7.50, both \$12.50 ppd. Tony Vitolo, WB4BKV, 1967 Tanglewood Drive, Snellville, Ga. 30278. Other sizes on request.

**PC 2406A MODU-CLOCK**, LED Clock Kit! Six Digit, 12/24 Hour, XTAL Time Base. Includes Drilled, Plated PC Board and Instructions. Thousands sold nationally! Satisfaction Guaranteed! Order now. 48 Hour Shipping! Only \$7.95. REL Electronics, 3511 Lynette Dr., Amarillo, Texas 79109.

**MANUALS** for most ham gear made 1940/65, some earlier. Send SASE for specific quote. Hobby Industry, WØJJK, Box H-864, Council Bluffs, Iowa 51501.

**STOLEN:** IC-230 (No. 240 1926), Heathkit HWA-202-6 Colinear, and Data Tone 2 touch tone encoder. Stolen from my car in Tampa, FL on Oct. 31, 1975. Report filed with Hillsborough County Sheriff Dept. Bud Holman, WA4ASJ, P. O. Box 698, Vero Beach, FL 32960.

**SUPERDESIGNED** — New electronic products for the Ham & Workbench. Sweep/FSK/Function Generator. Power supply splitter converts single supply to dual source. Speech compressors. More! Free Catalog. MINITRON, Box 184, Anoka, Minn. 55303.

**SB-104 OWNERS CLUB** — Expanding its horizons to include the HW-104 and the new Heath 2 meter equipments. Newsletter, builders guides, modification information and other services on current Heathkit amateur equipments. Send SASE for details to Chuck Harrison, RD 2 Box 1, North Stonington, CT 06359.

**TS-413 SIGNAL GENERATOR**, 75 kHz to 40 MHz, decade attenuator, metered output, \$80. TS-419A generator, 900-2100 MHz, \$140. HP-612A generator 450-1230 MHz, \$550. HP-207H Univerter, \$120. HP-410B VTVM, \$75. Jim Walter, 2697 Nickel St., San Pablo, Ca. 94806.

**STOLEN** in Chicago area on 10-25-75. KDK 144-105X Serial #5446. Nick Kalafice, WØOZZ, 117 West Glencrest Drive, Mankato, Minn. 56001. 507-387-2279.

**KLM PRODUCTS**, Larsen ants., Icom, police and fire scanners. Send for prices. Not given over phone. Narwid Electronics, 61 Bellot Road, Ringwood, N. J. 07456.

**SELL:** SSTV Sumner 3KB Keyboard. Excellent. \$325 firm. RTTY CV-89 T.V., excellent, \$125 firm. Write, no phone. R. Hanson, WB2DHL, RD 3, Oswego, N. Y. 13126.

**LEARN CODE IN A FEW DAYS** with audio reflex method of teaching letters, numbers, punctuation. One hour cassette only \$7.00. Guardian, 20 E. Main St., Ramsey, N. J. 07446.

**NOVICE, GENERAL AND CODE COURSES** are available at the Harrison, New York School of Continuing Education. 10 two hour sessions one evening a week. Contact George Buchanan WB2FVX, (914) RO-1-4183.

**PAYING 5% OVER BEST OFFER** for Eimac/Varian tubes, ham and commercial gear, etc. Ted Dames, W2KUW, 308 Hickory St., Arlington, N. J. 07032. (201) 998-4246.

**MANUALS** for Govt. surplus gear, \$6.50 each: URM-25D, OS-8C/U, SP-600JX, TT-63A/FGC, TS-497B/URR, BC-348J, N, Q, TS-382D/U, ALR-5. Thousands more available. Send 50¢ (coin) for 22-page catalog. W3IHD, 7218 Roanne Drive, Washington, D. C. 20021.

**THE 21ST ANNUAL HAM AUCTION.** America's Largest. Saturday, March 13, 1976, at Lucas County Recreation Center, Toledo, Ohio. Auction, flea market, commercial displays, prizes. 8:00 a.m. to 5:00 p.m. \$1.50 advance, \$2.00 after March 1st. Send SASE. Talk-in 146.52. Toledo Mobile Radio Association, Box 273, Toledo, Ohio 43696.

**REGULARLY \$1,200.00. NOW ONLY \$995.00 EACH.** Hammarlund HQ215 solid state HAM BAND/general coverage receiver mint. at \$325.00. Send self addressed stamped envelope for large list of used gear to: HCJ Electronics, 8214 E. Sprague, Spokane, Wa. 99208. Phone 509-924-2343.

**RARS 1976 ANNUAL HAMFEST**, April 11. For details write: RARS, Box 17124, Raleigh, N. C. 27609.

**SALE** — KWM-2, AC supply, 30L-1, \$1150.00. Phone 214-792-1378. J. R. Scott, No. 18 Tamar Dr., Texarkana, Texas 75501.

**YOUR AD belongs here too.** Commercial ads 40¢ per word. Non-commercial ads 10¢ per word. Commercial advertisers write for special discounts for standing ads not changed each month.

**UNIVERSAL TOWERS**  
**FREE STANDING ALUMINUM TOWER**  
 10' to 100'  
 Prices from \$110.00 (30')



**MOST POPULAR HAM TOWER EVER MADE!**

**REQUEST NEW CATALOG OF TOWERS & ANTENNAS**

**Midwest Ham Headquarters**  
*For Over 36 Years*  
**HAMS! Write For Free Catalog and Wholesale Prices!**  
**ELECTRONIC DISTRIBUTORS, INC.**  
 1960 Peck Muskegon, MI 49441  
 Tel: 616-726-3196 TELEX: 22-8411

**Webster radio**  
 Write today for brochure on:  
**CTC UHF/VHF HIGH POWER TRANSISTORS**  
*Everything from Set to Signal!*  
 2602 E. Ashlan, Dept. H Fresno, Calif. 93726  
 (209) 224-5111

**NEW YEAR SPECIAL!**  
 Complimentary issue of **THE BIG LIST** from Buyers & Sellers. Check off #329.  
**BUYERS & SELLERS**  
 P.O. Box 73  
 Kenmore Station  
 Boston, Mass. 02215 **617-536-8777**

**RMS CORPORATION**  
**THE ELECTRONIC STORE**  
 675A GREAT ROAD (ROUTE 119)  
 LITTLETON, MASS. 01460  
 (617) 486-4973

ICOM MATRIC-KEYERS  
 HUSTLER ANTENNA SPECIALISTS  
 CONSIGNMENT EQUIP. LARSEN  
 KLM RADIO PUBLICATIONS  
 LARGE INV. COMPONENTS  
 USED EQUIP.

I-495 to Rte. 119 Groton Exit 19  
 2 miles on Right

**SEE US FOR KLM's MULTI-2000**



**0.1 Hz. to 100 KHz.**



**For only \$39.95**

Our new FG-2 Function Generator kit gives you all five of the most useful waveforms for design and testing at one fourth the cost of previous similar instruments. Thanks to improved IC's the FG-2 now features amplitude stability of  $\pm 1$  db over any range, Sine wave distortion of less than 1% from 20 Hz. to 20,000 Hz. and an output of 4.0 Volts peak-to-peak with adjustable offset. The offset selector lets you put the positive peak, negative peak, or the center of the waveform on DC ground. The DC coupled circuit keeps the waveforms in exactly the same position no matter what the level control setting.

Gray impact plastic case 5 1/4 x 6 1/4 x 2 1/4. 115 Volts 60 cycle power supply included.

FG-2 Function Generator Kit shipping weight 3.0 lbs.....\$39.95 PPd

**SEND FOR OUR NEW 1976 CATALOG**

listing this and other unique kits  
**"FREE"**  
 by simply circling our number on the reader service card.

**SWTC** SOUTHWEST TECHNICAL PRODUCTS CORPORATION  
 DEPT. H  
 219 W. Rhapsody  
 San Antonio, Texas 78216

**NOW**  
is the time to order  
**YOUR**  
**76**  
**callbook**

Don't wait until 1976 is half over. Get your new **Callbooks** now and have a full year of the most up-to-date QSL information available anywhere.

The new 1976 U. S. **Callbook** has over 300,000 W & K listings. It has calls, license classes, names and addresses plus the many valuable back-up charts and references you have come to expect from the **Callbook**.

Specialize in DX? Then you're looking for the new, larger than ever 1976 **Foreign Callbook** with over 225,000 calls, names and addresses of amateurs outside of the USA.

On dealer shelves NOW!

Foreign Radio Amateur Callbook DX Listings \$12.95 with 3 Service Editions \$18.95

United States Callbook All W & K Listings \$13.95 with 3 Service Editions \$19.95

RADIO AMATEUR **callbook** INC.  
Dept. E 925 Sherwood Drive  
Lake Bluff, Ill. 60044

Order from your favorite electronics dealer or direct from the publisher. All direct orders add \$1.00 shipping and handling per Callbook.

## PORTA-PAK



**SUGGESTIVE? SURE!**

**THE DELUXE PORTA-PAK  
NOT ONLY SUGGESTS  
BUT DELIVERS:**

ATTRACTIVE PACKAGE  
DURABILITY PLUS  
OPERATION ANYWHERE **\$59.95**  
FULL POWER  
OVERNIGHT RECHARGING

PORTA-PAK IS THE ACCESSORY  
THAT MAKES YOUR MOBILE RADIO  
REALLY PORTABLE. AVAILABLE  
FOR MOST F.M. TRANSCIEVERS AT  
**\$59.95 WHICH INCLUDES CHARGER.**

**PORTA-PAK**  
P. O. BOX 67  
SOMERS, WI. 53171



### INFO-TECH MODEL 30 MORSE TO VIDEO CONVERTER

CONVERTS RECEIVED MORSE CODE  
FROM YOUR RECEIVER TO A VIDEO  
PRINTOUT ON YOUR T.V., NO OTHER  
DEVICES REQUIRED

**FEATURES:**

- NO CRITICAL ADJUSTMENTS
- ATTACHES TO ANY CW RECEIVER WITH B.F.O. AND 3 TO 600 OHM AUDIO
- SIMPLE LED TUNING INDICATOR
- UNIQUE P.L.L. FRONT END INPUT FILTER FOR SUPERIOR SELECTIVITY
- AUTOMATIC SPEED AND WEIGHT ADJUSTMENT: TRACKS 8 TO 150 W.P.M.
- SIMPLE CONNECTION TO YOUR T.V. SET'S VIDEO AMP FOR EXCELLENT CLARITY
- PRINTS 8 LINES, FOR A TOTAL OF 256 CHARACTERS
- TEXT SHIFTS UPWARDS AS MESSAGE CONTINUES WITH AUTOMATIC CARRIAGE RETURN AND LINE FEED (Scrolling)
- WILL ACCEPT PARALLEL ASCII WITH STROBE FOR MICRO COMPUTER APPLICATIONS
- BUILT IN AC POWER SUPPLY
- RTTY INTERFACE AVAILABLE WITH OR WITHOUT VIDEO BOARD TO DRIVE YOUR PAGE PRINTER (Extra Charge)
- PRICE \$299.50 DELIVERED IN CONTINENTAL USA
- WRITE FOR BROCHURES

### INFO-TECH INC.

P. O. BOX 84  
CHESTERFIELD, MISSOURI  
63017



## ELPROCON 1 WATT 2 METER TRANSMITTER

- 2 CHANNEL OPERATION
- FREQUENCY RANGE 144-148 MHz
- 1 WATT MINIMUM POWER OUTPUT @ 12.5 vdc
- 50 OHM RF OUTPUT IMPEDANCE
- 8X MULTIPLICATION FACTOR
- NARROW BAND FM ± 5 KHZ
- RUGGED BALANCED EMITTER OUTPUT TRANSISTOR
- SIZE 3 3/4" L X 1 7/8" W X 1" H
- TESTED & FULLY ASSEMBLED (Less xtals)



• \$32.95 price includes all postage fees

### ELPROCON

DEPT. DS • 1907 W. CAMPBELL  
PHOENIX, ARIZONA 85015

the action and  
adventure in  
amateur radio:

## WORLD RADIO

—monthly publication—

trial subscription  
next 2 issues \$1

2120 28th St.

Sacramento, CA

95818 —W6AJY

**NEWS**

### ALDELCO Semiconductor Supermarket

SN7490 Decade Counter	80¢
SN74121 Monostable	55¢
555 Timer	70¢
709 or 741 14 pin DIP	25¢ ea.
<b>RF DEVICES</b>	
2N3375, 3W 400 MHz	\$5.50
2N4041, 1W, 400 MHz	\$5.25
2N5590, 10W, 175 MHz	SPL \$6.75
2N6080, 4W, 175 MHz	\$5.40
2N6081, 15W, 175 MHz	\$8.45
2N6082, 25W, 175 MHz	\$10.95
2N6083, 30W, 175 MHz	\$12.30
2N6084, 40W, 175 MHz	\$16.30
FT0601, FET	99¢ ea.
2N3819, FET	35¢ ea.
2A, 1000V, Rect., RCA	10 for 99¢

**HEAVY DUTY RECTIFIERS**

DO8, 200V, 100A	\$5.50
DO9, 200V, 250A	\$8.50
10,000 volt Silicon Rect., ERIE	\$2.95
200 volt, 25A Bridge	3 for \$1.00
1N2637 (replaces 866, 866A, 3B28)	\$9.80
ZENERS, 400mw 1N746 to 1N759	25¢ ea.
ZENERS, 1w, 1N4728 to 1N4764	35¢

We will quote on any quantity. All items postpaid USA & Canada. Send for flyer.  
**ALDELCO, P. O. BOX 341H  
LYNBROOK, N. Y. 11563**

### CASH FOR 2-WAY FM RADIO MOTOROLA, GE, RCA, ETC. EQUIPMENT

MOBILES, BASES, PORTABLES, MOBILE-TELEPHONES, REPEATERS, REMOTE CONTROLS, TONE EQUIPMENT, 2-WAY TEST EQUIPMENT  
Operational Units Only  
Commissions/Finders Fees  
**CAL-COM SYSTEMS, INC.**  
701-51A KINGS ROW, SAN JOSE, CALIF. 95112  
Telephone 24 Hours 408/998-4444

**MODSET:** precision modulation measurements for AM-SSB, 0.2 to 300 MHz, \$29.50 (Kit: \$19.50)

**D. R. CORBIN MFG. CO.**

P. O. Box 44, North Bend, Ore. 97459



## Ham Radio's guide to help you find your local Amateur Radio Dealer

### California

#### HENRY RADIO

931 N. EUCLID AVE.  
ANAHEIM, CA 92801  
714-772-9200  
The world's largest distributor of Amateur Radio equipment.

#### HENRY RADIO CO., INC.

11240 W. OLYMPIC BLVD.  
LOS ANGELES, CA 90064  
213-477-6701  
The world's largest distributor of Amateur Radio equipment

### Colorado

#### C W ELECTRONIC SALES CO.

1401 BLAKE ST.  
DENVER, CO 80202  
303-573-1386  
Rocky Mountain area's complete ham radio distributor.

### Illinois

#### SPECTRONICS, INC.

1009 GARFIELD STREET  
OAK PARK, IL 60304  
312-848-6778  
Chicagoland's Amateur Radio leader.

### Indiana

#### HOOSIER ELECTRONICS

P. O. BOX 2001  
TERRE HAUTE, IN 47802  
812-238-1456  
Ham Headquarters of the Midwest.  
Store in Meadow Shopping Center.

### Kansas

#### AMATEUR RADIO EQUIP. CO., INC.

1203 E. DOUGLAS  
WICHITA, KS 67211  
316-264-9166  
Assisting the Amateur since 1949.

#### ASSOCIATED RADIO

8012 CONSER P.O.B. 4327  
OVERLAND PARK, KS 66204  
913-381-5901  
Amateur Radio's Top Dealer.  
Buy — Sell — Trade.

### Massachusetts

#### TUFTS RADIO ELECTRONICS

386 MAIN STREET  
MEDFORD, MA 02155  
617-395-8280  
New England's friendliest ham store.

### Michigan

#### AUDIOLAND

36633 SOUTH GRATIOT  
MT. CLEMENS, MI 48043  
313-791-1400  
All major brands, new/used equipment & accessories.

#### ELECTRONIC DISTRIBUTORS

1960 PECK STREET  
MUSKEGON, MI 49441  
616-726-3196  
Communication specialists for over 37 years.

#### RADIO SUPPLY & ENGINEERING

1203 WEST 14 MILE ROAD  
CLAWSON, MI 48017  
313-435-5660  
1801 Chalmers, Detroit, MI 48213, 313-371-9050.

### Minnesota

#### ELECTRONIC CENTER, INC.

127 THIRD AVENUE NORTH  
MINNEAPOLIS, MN 55401  
612-338-5881  
ECI is still your best buy.

### Missouri

#### HAM RADIO CENTER, INC.

8342 OLIVE BLVD.  
P. O. BOX 28271  
ST. LOUIS, MO 63132  
800-325-3636  
Call toll free.

### Nebraska

#### COMMUNICATIONS ENGINEERING

4341 N. 61ST  
LINCOLN, NE 68507  
402-464-7571  
See us for service and modifications.

### New Jersey

#### ATKINSON & SMITH, INC.

17 LEWIS ST.  
EATONTOWN, NJ 07724  
201-542-2447  
Ham supplies since "55".

### New York

#### ADIRONDACK RADIO SUPPLY, INC.

185 W. MAIN STREET  
AMSTERDAM, NY 12010  
518-842-8350  
Yaesu dealer for the Northeast.

#### CFP COMMUNICATIONS

211 NORTH MAIN STREET  
HORSEHEADS, NY 14845  
607-739-0187  
Jim Beckett, WA2KTJ, Manager  
Dave Flinn, W2CFP, Owner

### Ohio

#### UNIVERSAL SERVICE

114 N. THIRD STREET  
COLUMBUS, OH 43215  
614-221-2335  
Give U.S. a try when ready to buy.

### Pennsylvania

#### ARTCO ELECTRONICS

302 WYOMING AVE.  
KINGSTON, PA 18704  
717-288-8585  
The largest variety of crystals in N. E. Penn.

#### ELECTRONIC EXCHANGE

136 N. MAIN STREET  
SOUDERTON, PA 18964  
215-723-1200  
New & Used Amateur Radio sales and service.

#### HAMTRONICS, INC.

4033 BROWNSVILLE ROAD  
TREVOSE, PA 19047  
215-357-1400  
Same location for 25 years.

### South Dakota

#### BURGHARDT AMATEUR CENTER

124 FIRST AVE. N.W. P.O. BOX 73  
WATERTOWN, SD 57201  
605-886-7314  
America's most reliable Amateur Radio Dealer — Nationwide!

### Texas

#### ALTEC COMMUNICATIONS

1800 S. GREEN STREET  
LONGVIEW, TX 75601  
214-757-2831  
Specializing in ham equipment for the Ark-La-Tex.

### Virginia

#### ARCADE ELECTRONICS

7048 COLUMBIA PIKE  
ANNANDALE, VA 22003  
703-256-4610

### Washington

#### AMATEUR RADIO SUPPLY CO.

6213 13TH AVE. SO.  
SEATTLE, WA 98108  
206-767-3222  
Amateur center of the Northwest.

*Dealers - You should be here too! Contact Ham Radio today for complete details.*

# TROPICAL HAMBOREE

Bayfront Park Auditorium  
Miami, Florida



## January 24-25



MANUFACTURER'S EXHIBITS

GIANT HAMBOREE SWAP SHOP

HAMBOREE PRIZE AWARDS

ARRL GENERAL SESSION (Sunday)

REGISTRATION - \$2.00

## DADE RADIO CLUB

P.O. BOX 520073, BISCAYNE ANNEX, MIAMI, FLA. 33152

# Semiconductor Supermarket

ALL DEVICES AND COMPONENTS ARE FACTORY FIRSTS  
- NO SECONDS OR FALLOUTS

## VHF PRESCALER DEVICES AND KITS

95H90	300 MHz 10 prescaler	\$15.95	2N5179	Wideband preamp trans.	\$.80
95B2	Preamp/gate	\$3.25	250 MHz SCALER KIT	includes 95H90, 2N5179 Circuit Board, small parts and instructions. Requires 5V power source — not included	ONLY \$24.95
95H91	Prescaler	\$15.95	500 MHz Prescaler		\$43.95
11C06	500 MHz scaler	\$21.95			

## FETs

MPF102	JFET	\$.60	MFE3007	Dual-gate	\$1.98
MPF105/2N5459	JFET	\$.96	40673	Dual-gate	\$1.25
MPF107/2N5486	JFET VHF/UHF	\$1.26	3N140	Dual-gate	\$1.95
MPF121	Low-cost dual gate	\$1.40	3N141	Dual-gate	\$1.86
	VHF RF				

## TOROID CORES

PRICE — \$1.00 PACKS

Quantity	Core	Color	Frequency
3	T50-2	Red	To 20 MHz
3	T68-2	Red	To 20 MHz
3	T50-6	Yellow	To 75 MHz
3	T50-10	Black	To 200 MHz
3	T44-10	Black	To 200 MHz

ALSO

T200-2 ONLY \$2.00 ea.

## BARGIN SQUARE

7400	.15 ea. 10 for \$1.25
7490	.55 ea. 10 for 5.00
7475	.55 ea. 10 for 5.00
7447	.99 ea. 10 for 9.90
7473	.36 ea. 10 for 3.00
7474	.36 ea. 10 for 3.00
14-PIN Skts	.20 ea. 10 for 1.50
16-PIN Skts	.20 ea. 10 for 3.00

SEND FOR  
FREE CATALOG

Please add 40¢ for shipping

**CIRCUIT SPECIALISTS CO.**

Box 3047, Scottsdale, AZ 85257

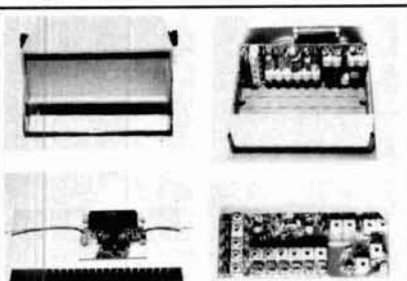

## NEW FM XMTR KITS

- 2M, 200 MW FM/CW EXCITER \$39.95
- 432-450 MHz TRIPLER/DRIVER \$19.95
- 20-25W 2M PA OR 13-15W 432-450 PA, using new RF power modules \$79.95
- CABINET for xcvr or other projects \$27.95

SEND SASE FOR CATALOG, INCL RCVRs, PREAMPS, ETC —

**hamtronics, inc.**

182 BELMONT RD., ROCHESTER, NY 14612

## EEB

Announces New Industrial Division

HP	SCOPES	DC
TEKTRONIX	RECEIVERS	AUDIO
DEI	COUNTERS	VIDEO
CEI	SIGNAL GENERATORS	HF/VHF/UHF
GENERAL	RECORDERS	MICROWAVE
RADIO	SIGNAL CONDITIONING	TELEMETRY
ETC.	POWER SUPPLIES	

If your organization has test equip. requirements call or write EEB. Inquiries welcomed.

## This Month's Special

DEI Spectral Display Unit, Model TDU-4 - 30 MHz center frequency - Bandwidth is 3 MHz.



New in factory cartons \$295.00

Other Display Units include TDU-3, Nems Clarke/Vitro Model SDU-200, -300 — Center freq. 30 or 21.4 MHz (Specify) — New and Used — Prices range \$95 - \$295.

## CLOSE OUT SPECIAL — \$19.95

while they last ppd. USA

## ARR-52

Easily converted to 2-meter FM. Now set for 163-173 MHz, 16 channels. Includes schematic diagram and conversion details. As described in the Surplus Sidelights Column, (Pg. 58 Oct. CQ).

OVER 400 SOLD

BankAmericard & COD Welcome

**Electronic Equipment Bank, Inc.**

516 Mill Street, N.E. Vienna, Virginia 22180  
(703) 938-3350

## SOLID STATE VHF RECEIVER



## TOUCH-TONE ENCODER

### FEATURES:

- Crystal Controlled - Digitally Synthesized Tones.
- Low Current Drain CMOS Logic.
- RFI Immune.
- 16-Button Tactile Feedback Keyboard.
- Will Interface to Transceivers Using Dynamic Microphones with Only Two Wires.
- Provisions for Three Wire Interface Are Provided.
- Gold-Plated Keyboard Contacts Provided for Maximum Reliability.
- Operating Voltage Range 9-18VDC.
- Size: 2.1" x 2.1" x .250" Without Case. 2.1" x 2.1" x .312" With Case.
- 2" Square Velcro Available for Convenient Mounting - Dashboard - Sun Visor - Radio - Etc.

Touch-Tone Encoder	\$29.50
Case	\$ 2.00
Velcro	\$ .50

OHIO RESIDENTS ADD 4.5% SALES TAX

SEND CHECK OR MONEY ORDER TO:

**The Barber Corporation**

P. O. BOX 271

WAYNESVILLE, OHIO 45068

513-897-2926

# FM SOLID STATE PUNCH

AM-CW-SSB

FM-AM-CW-SSB MOBILE/BASE

High Power

## 2 METER AMPLIFIERS



### Case Dimensions

- A 2-1/2" H x 3-7/8" W x 4" Deep
- B 2-1/2" H x 5-1/2" W x 7" Deep
- C 2-1/2" H x 5-1/2" W x 11" Deep

Model	Drive Power	Output Power	Current Drain	Max. Drive	Case Size	Price
RFA-3-40-HB	3 Watts	40 Watts	4 Amps	5 Watts	B	\$129.95
RFA-3-60-HB	3 Watts	60 Watts	7 Amps	5 Watts	B	159.95
RFA-3-110-HB	3 Watts	110 Watts	14 Amps	5 Watts	C	199.95
RFA-3-200-HB	3 Watts	200 Watts	24 Amps	5 Watts	C	349.95
RFA-10-75-HB	10 Watts	75 Watts	8 Amps	15 Watts	B	129.95
RFA-10-100-HB	10 Watts	100 Watts	13 Amps	15 Watts	B	189.95
RFA-10-150-HB	10 Watts	150 Watts	17 Amps	15 Watts	C	239.95
RFA-25-150-HB	25 Watts	150 Watts	17 Amps	40 Watts	C	249.95
RFA-25-200-HB	25 Watts	200 Watts	22 Amps	40 Watts	C	299.95
RFA-1-75-HB	1 Watt	75 Watts	9 Amps	5 Watts	B	179.95
RFA-1-25-HB	1 Watt	25 Watts	3 Amps	4 Watts	A	99.95

**Dealer and Distributor  
Inquiries solicited**

All models will operate with reduced output from as little as one watt drive. Amplifiers are supplied pre-tuned for band portion in which they are to be used. Comparable models for 6 and 10 meters are also available.



DIVISION OF **EGI** ELECTRONICS GROUP INC.

2204 Foster Avenue • Wheeling, Illinois 60090 • 312/392-6030

**Bird** We are official distributors for Bird Wattmeters and elements. RF thru-line Wattmeters & most elements now in stock.

**Drake**

- R4-C Receiver \$549.00
- SPR-4 Solid State Gen. Cov. Receiver \$599.00
- T-4XC Transmitter \$580.00
- MS-4 Speaker \$24.95
- AC-4 Power Supply \$120.00
- TR-22C, 2 meter FM, portable transceiver with NiCads, case \$229.95
- TR-4C, 10 thru 80 M, SSB, AM, CW transceiver \$599.95
- L-4B Linear Amp w/P.S. & tubes \$825.00
- MN-4 Antenna Matching Network \$110.00
- DSR-2 VLF thru HF Digital Synthesized Communications Lab Rcvr \$2950.00
- NEW — SSR-1 Gen. Cov. solid state, synth. rcvr. \$350.00

Order all your other Drake products through Barry!

**C.D. Ham II Rotator**

Includes brushed aluminum-pin with your call!!!

**New Improved \$139.95**

\$159.95 net SAVE \$20

8 conductor cable for HAM II or CD-44 16¢/ft.

**ANTENNAS — TA-36 & other beams in stock, write or call.**

- Antenna Specialists' amateur and marine antennas stocked in depth.
- Antenna Specialists HM-4 Rubber Ducky. (2M, 5/16"-32 for Motorola/Johnson, etc.) \$7.00
- Antenna Specialists HM-5 Rubber Ducky. (w/ PL259 for TR-22C, etc.) \$7.00
- CushCraft Antennas now in stock.**
- New Ringo Ranger ARX-2, 6 dB base antenna \$26.50
- HyGain 1/4 wave 2M grd plane \$13.00
- HyGain BN86 Deluxe Balun \$15.95
- HyGain 18 AVT/WB 10-80 meters vertical \$97.00
- Newtronics G6-144A fixed station antenna 6dB gain \$52.00

Tubes for worldwide and domestic, commercial service. Large stocks of meters and capacitors.

Newtronics BBLT 2 Meter Mobile Antenna with trunk lip mt, 3.4dB gain, 143 thru 149 MHz \$28.75  
Times Wire & Cable, T-4-50, RG-8 foam 28¢/ft.  
Distributors for Tri-Exand Rohn Towers.  
IC-230 — Call or write \$489.00  
Astatic Model T-UG8-D104 Mike w/stand \$48.60

Also Stock Shure Communications Microphones.

- B & W 850A or 852 for PiNet Band switching inductor for \$74.95
- B & W 334A Dummy Load-Wattmeter 0-300 MHz 52Ω, 0-10, 100, 300, 1000 watts \$167.50
- B & W 374 Dummy Load-Wattmeter 0-300 MHz 52Ω 0-15, 50, 300, 1500 watts \$195.00
- Sockets for 8072, 8121, 8122 Write EBC Jr.-2 meter FM synthesized XCVR \$599.00
- MC Jones Mod. 575.5 Micro Match SWR bridge, N Connectors. For use with 200µa meter. New value \$100.00 \$24.95

**BARRY BUYS UNUSED TUBES AND VACUUM CAPACITORS.** Send Your List, Tube Headquarters. Diversified Stock. Heavy Inventory of Eimac tubes, chimneys, sockets, etc. 3-500Z \$63.00 or 3-400Z \$50.00.

**NEW ARRIVALS**

- Motorola Rcvr Model R-220/URR freq. 19.74 thru 237.97 MHz. Continuous tuning — AM/FM/CW. Excellent condition with complete manual — Lab certified \$450.00
- National NCX-500 Transceiver (10-80m) with Nat'l matching AC supply — very good condition — Lab tested with manual \$275.00
- Hallcrafters FPM-300 Transceiver (80-10m) with manual. Mint condition. \$395.00
- Hallcrafters SX-130 Gen. Cov. Ham Rcvr, excellent, very clean condition with manual \$159.00

**Collins 75S-1 Receiver with Collins 32S-1 Transmitter and Collins 516F2 Power Supply.** Sell as package with manuals — good condition Write or call Hi Power Matchbox for comm'l use — handles up to 10 kW (10-160 meters) \$350.00

**Heathkit SB610, SB630 Write Johnson Matchbox, 275w, w/SWR, mint \$139.00**

Millen 2KW Transmatch Write Signal Elec. Telegraph Sounder, never used, orig. cnts. \$19.95

**NEW ITC Multi 5000, synthesized, FM, AM, USB, LSB, adjustable 1-80 watts \$695.00**  
13.6 Volt, 15A, regulated supply ordered with above \$55.00

Ameco Model PT Preamp, factory wired \$69.95  
Regency HR-6 6 mtr FM transcvr. Brand New — Reg. \$239.95 Now \$175.00

**DX Engineering Speech Compressor for Collins 32S xmtr \$98.50; for Collins KWM2 \$98.50; for Drake TR4-(C) \$128.50.**

**TEN-TEC DISTRIBUTOR — Order through Barry.**

KR50 Keyer \$110.00  
Triton IV \$599.00

- Johnson 154-10 or equal. Single section 23 thru 347 pF for KW transmatch. Replaces Millen 16520 \$36.00
- Johnson 229-202 or equal. 18 mH variable inductor 10 to 80M for KW transmatch \$39.00
- Johnson 229-203 or equal. 28 mH variable inductor 10 to 160M for KW transmatch \$39.00
- Hammarlund Dual Section 320/320 per section Xmit'g Capacitor \$29.95

**NPC POWER SUPPLIES**

- Model 102 115V AC Input - 12 VDC 4 amps max. out \$25.00
- Model 104R regulated 13.6 VDC 4A cont. 6A max. \$49.00
- Model 108R — 115 VAC/13.6 VDC 8 amps continuous 12 amps surge. Regulated \$72.00

**LARGE STOCK!**

B & W Miniductors — Air Dux coil stock  
Millen Components — National Parts.

**WE HAVE VIBROPLEX IN STOCK!**

- Orig. Deluxe Vibroplex "bug" \$46.70
- Vibroplex Vibro Keyer Standard \$30.75
- Vibroplex Vibro Keyer Deluxe \$39.95

**Store Hours**

Saturday, 10 a.m. - 4 p.m.

Monday-Friday, 9 a.m. - 6:00 p.m.

**BARRY 512 Broadway NY, NY 10012**

DEPT. H-1  
212-WA-5-7000

**ELECTRONICS**

TELEX 12-7670

Add shipping-excess refunded-Quoted FOB N.Y.C.

**We're Fighting Inflation No Price Rise for '76**



**FOR FREQUENCY STABILITY**

Depend on JAN Crystals. Our large stock of quartz crystal materials and components assures Fast Delivery from us!



**CRYSTAL SPECIALS**

- Frequency Standards
- 100 KHz (HC 13/U) \$4.50
- 1000 KHz (HC 6/U) 4.50

Almost all CB sets, TR or Rec \$2.50 (CB Synthesizer Crystal on request)

Amateur Band in FT-243 ea. \$1.50

4/\$5.00

80-Meter- \$3.00 (160-meter not avail.)

For 1st class mail, add 20¢ per crystal. For Airmail, add 25¢. Send check or money order. No dealers, please.



Div. of Bob Whan & Son Electronics, Inc.  
2400 Crystal Dr., Ft. Myers, Fla. 33901  
All Phones: (813) 936-2397  
Send 10¢ for new catalog

**This Month's Specials**

**Thumbwheel Switches EECO Model 805M 0 to 9 BCD and Compliment** (These switches are used but are in good condition and are perfect for Ham Use)

**Price:**  
1-10 \$1.95, 11-25 \$1.65, 26 and up \$1.25

Tubes New	Tubes Used But OK
2E26 \$4.00	807 \$2.50
572B/T160L \$22.00	2C39A \$2.75
811A \$5.50	7289 \$3.75
6146A \$4.25	
6146B/8298A \$5.50	<b>More New Tubes</b>
6L06 \$3.95	4X150A \$15.00
8950 \$5.50	4C150G \$18.00
8072 \$35.00	4CX250F \$22.00
	4CX250B \$24.00

RF Transistors		
2N2857 \$1.85	2N3866 \$1.08	
2N4072 \$1.50	2N4427 \$1.20	
2N5179 \$0.59	2N5589 \$4.60	
2N5590 \$6.30	2N5591 \$10.35	
2N6080 \$5.45	2N6081 \$8.60	
2N6082 \$11.25	2N6083 \$12.95	
2N6084 \$17.25	2N6166 \$85.00	

**Wire:** RG174/U 24Awg. 7/34 Strand. These are in 5 foot lengths.

Price per 50 lengths \$6.95

Price per 100 lengths \$11.95

Spectra Strip Type 2444 16 conductors 7 strand 24 Awg.

Price 1 to 25", .39"

**MHz electronics**

2543 N. 32ND ST.  
PHOENIX, ARIZONA 85008  
PH. 602-957-0786

**MICROCOMPUTER INTERFACING WORKSHOP**, March 12-13, 1976. A two-day workshop based on the popular Intel 8080 micro processor. This course is sponsored by the Virginia Polytechnic Institute and State University Extension Division at the VPI Center in Reston, Va. (near Dulles Airport). This workshop will include many hours of experience in programming and interface construction with over 12 operating microcomputers for participant use. For more information contact Dr. Norris Bell, V.P.I. and S.U. Continuing Education Center, Blacksburg, Va. 24061. 703-951-6328.

**DIGITAL ELECTRONICS FOR AUTOMATION AND INSTRUMENTATION**, March 21-26 which is a hands-on laboratory/lecture course covering basic digital electronics as well as data communications and interfacing using asynchronous serial techniques. It is held at Virginia Polytechnic Institute and State University in Blacksburg, Va. and is sponsored by the American Chemical Society, Education Division, 1155 16th St., N.W., Washington, D. C. 20036. (202)-872-4528.

**LEARN RADIO CODE**

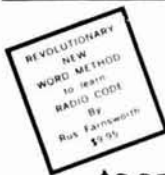

**THE EASY WAY!**

Based on modern psychological techniques — This course will take you beyond 13 w.p.m. in LESS THAN HALF THE TIME!

- No Books To Read
- No Visual Gimmicks To Distract You
- Just Listen And Learn

Album contains three 12" LP's 2½ hr. instruction

Available in Cassette also for only \$10.95.

**EPSILON RECORDS**

508 East Washington St., Arcola, IL 61910

**Get twice the  
keyboard  
for your money.**



The HAL DKB-2010 keyboard does double duty.

For the price of an ordinary keyboard, you can send both TTY and CW. At the flick of a switch, send TTY at all standard data rates, or perfect CW at 8-60 wpm. You get complete alphanumeric and punctuation keys, a "DE-call letters" key, even a "QUICK BROWN FOX..." diagnostic key for TTY. In both modes, you have a three-character buffer for bursting ahead (larger buffers available), and in the CW mode you can adjust the dot-to-space (weight) ratio to your liking.

Like all HAL products, the DKB-2010 is built to commercial standards—yet this solid-state unit is available at a price you'll appreciate. It's like getting two keyboards for the price of one.

For all the details, write today. We'll answer you on the double.



HAL Communications Corp., Box 365, 807 E. Green St.  
Urbana, Illinois 61801 • Telephone: (217) 367-7373

**The HAL RVD-1005  
video TTY unit  
puts all these features  
in the picture.**



Picture the HAL RVD-1005 video TTY unit in your station. And start enjoying silent, trouble-free TTY reception.

The RVD-1005 converts the output of any TU into a clear, easy-to-read TTY video readout. The output signal can be fed to a TV monitor—like the RVD-2110 monitor shown—or, with slight modification, any standard TV receiver. The features speak for themselves. We've included everything the serious amateur requires for TTY receiving at its best.

Best yet, the RVD-1005 is built to commercial standards, yet is priced at a level the amateur TTY enthusiast will find very affordable.

For an in-depth picture, write today for complete information.



HAL Communications Corp., Box 365, 807 E. Green St.  
Urbana, Illinois 61801 • Telephone: (217) 367-7373

# Advertisers check-off

...for literature, in a hurry — we'll rush your name to the companies whose names you "check-off"

Place your check mark in the space between name and number. Ex: Ham Radio  234

## INDEX

A.C.E. _____ 392	Jan _____ 067
A & W _____ 359	Janel _____ 068
Adva _____ 265	Jensen Tools _____ 293
Aldelco _____ 347	K-Enterprises _____ 071
Apollo _____ 011	KLM _____ 073
Aptron _____ 380	Kensco _____ 394
Atlas _____ 198	Kenwood _____ 341
Atronics _____ 382	King Prod. _____ 373
Babylon _____ 014	Levy _____ 291
Barber _____ 383	Lyle _____ 373
Barry * _____	MFJ _____ 082
Budwig _____ 233	MHz _____ 394
Bullet _____ 328	Maynard _____ 363
Buyers & Sellers _____ 329	Mini Products _____ 395
CFP _____ 022	M-Tech _____ 357
Cal-Com _____ 282	National Multi. _____ 396
Circuit Spec. _____ 026	N. R. I. _____ 397
Communications Specialists _____ 330	N.E. Digital _____ 336
Communication Specialties _____ 369	Northshore R.F. _____ 296
Corbin _____ 349	Optoelectronics _____ 352
Cush Craft _____ 035	Palomar _____ 093
D-D _____ 269	Pinon _____ 337
Dames _____ 324	Porta-Pak _____ 274
Data Signal _____ 270	Pruitt _____ 365
Dentron _____ 259	RCA _____ 312
Drake _____ 039	RMS _____ 239
Ehrhorn _____ 042	Callbook _____ 100
Eimac _____ 043	Regency _____ 102
Electrografix _____ 371	Slep _____ 232
Elect. Dist. _____ 044	S.W. Tech. _____ 262
Elect. Equip. Bank _____ 288	Space _____ 107
ELPROCON _____ 301	Specialty Comm. Systems _____ 318
Epsilon _____ 046	Spectronics _____ 191
Erickson _____ 047	Spectrum Int. _____ 108
Fair _____ 048	Stahler _____ 142
Fluke _____ 049	Swan _____ 111
Genave _____ 168	Sys. Research _____ 392
Hal _____ 057	Telrex _____ 377
Hal-Tronix _____ 254	Ten-Tec * _____
Ham Radio _____ 150	Topeka FM _____ 115
Hamtronics _____ 246	Tropical Ham. _____ 185
Heath _____ 060	Tri-Ex _____ 116
Heights _____ 061	Triplet _____ 398
Henry _____ 062	Tucker _____ 113
Hewlett-Packard _____ 281	Tufts _____ 321
Hickok _____ 402	VHF Eng. _____ 121
Hildreth _____ 283	Vanguard _____ 346
Hosfelt _____ 390	Vibratrol _____ 251
Howard _____ 361	Va. Polytechnic * _____
HUFECO _____ 403	Visulex _____ 399
Hy-Gain _____ 064	Weber _____ 400
Icom _____ 065	Webster _____ 255
Info-Tech _____ 351	Weinschenker _____ 122
Int. Crystal _____ 066	Weirnu _____ 379
James _____ 333	Whitehouse _____ 378
	Wilson _____ 123
	Worldradio _____ 186
	Yaesu _____ 127

\*Please contact this advertiser directly.

Limit 15 inquiries per request.

January 1976

Please use before February 29, 1976

Tear off and mail to  
HAM RADIO MAGAZINE — "check off"  
Greenville, N. H. 03048

NAME \_\_\_\_\_  
CALL \_\_\_\_\_  
STREET \_\_\_\_\_  
CITY \_\_\_\_\_  
STATE \_\_\_\_\_ ZIP \_\_\_\_\_

# Advertisers iNdex

A.C.E. Laboratories _____	84
A & W Electronics _____	77
Adva Electronics _____	80
Aldelco _____	96
Apollo _____	94
Aptron Laboratories _____	73
Atlas Radio Co. _____	45
Atronics _____	71
Babylon _____	88
Barber Corporation _____	98
Barry _____	100
Budwig Mfg. Co. _____	93
Bullet _____	69
Buyers & Sellers _____	90, 95
CFP Communications _____	80
Cal-Com Systems, Inc. _____	96
Circuit Specialists Co. _____	98
Communications Specialists _____	2
Communication Specialties, Inc. _____	90
D. R. Corbin Mfg. Co. _____	96
Cush Craft _____	63
D-D Enterprises _____	78, 82
Dames, Ted _____	74
Data Signal, Inc. _____	67
Dentron Radio Co. _____	9
Drake Co., R. L. _____	7, 82, 102
Dynamic Electronics _____	94
Ehrhorn Technological Operations _____	6
Eimac, Div. of Varian Assoc. _____	Cover IV
Electrografix _____	88
Electronic Distributors _____	95
Electronic Equipment Bank, Inc. _____	98
ELPROCON _____	96
Epsilon Records _____	100
Erickson Communications _____	103
Fair Radio Sales _____	92
Fluke _____	88
General Aviation _____	75
Hal Communications Corp. _____	101
Hal-Tronix _____	93
Ham Radio _____	82
Hamtronics, Inc. _____	98
Heath Company _____	52, 53
Heights Manufacturing Co. _____	90
Henry Radio Stores _____	Cover II
Hildreth Engineering _____	80
Hosfelt Electronics _____	90
Howard Micro Systems, Inc. _____	77
HUFECO _____	82
Hy-Gain Electronics Corp. _____	48, 49
Icom _____	5
Info-Tech _____	96
International Crystal Mfg. Co., Inc. _____	35
James Electronics _____	83
Jan Crystals _____	100
Janel Labs _____	93
Jensen Tools _____	90
K-Enterprises _____	51
KLM Electronics _____	87
Kensco Communications, Inc. _____	92
Trio-Kenwood Communications, Inc. _____	27
King Products _____	86
Levy Associates _____	80
Lyle Products _____	92
MFJ Enterprises _____	80
MHz Electronics _____	100
Maynard Electronics _____	93
Mini Products _____	88
M-Tech _____	88, 92
National Multiplex Corp. _____	85
National Radio Institute _____	23, 93
New England Digital Electronics _____	88
Northshore RF Technology _____	92
Optoelectronics _____	71
Palomar Engineers _____	70
Pinon Electronics _____	51
Porta-Pak _____	96
Pruitt Enterprises _____	82
RMS Corporation _____	95
Radio Amateur Callbook _____	70, 96
Regency Electronics _____	81
Slep Electronics Co. _____	94
Southwest Technical Products _____	95
Space Electronics Corp. _____	90
Specialty Communications Systems _____	78
Spectronics _____	89, 90
Spectrum International _____	84
A. F. Stahler Co. _____	92
Swan Electronics _____	79, 86
Systems Research, Inc. _____	41
Telrex Labs _____	74
Ten-Tec _____	73
Topeka FM Communications _____	78
Tropical Hamboree _____	98
Tri-Ex Tower Corp. _____	1
Tufts Radio Electronics _____	94
VHF Engineering, Div. of Brownian _____	104
Vanguard Labs _____	70
Vibratrol _____	99
Virginia Polytechnic Institute _____	100
Visulex _____	86
Weber Electronics _____	74
Webster Radio _____	95
Weinschenker _____	92
Weirnu _____	90
G. R. Whitehouse Co. _____	92
Wilson Electronics _____	58, 59
Worldradio _____	96
Yaesu Musen USA _____	Cover III

# NEW

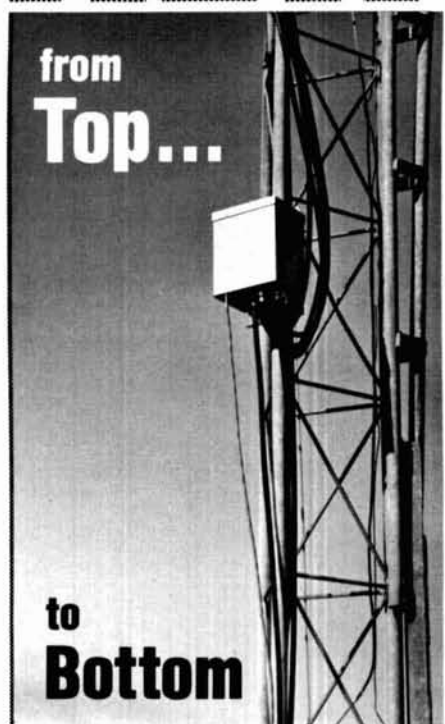

The Drake  
RCS-4

## Remote Motor-Controlled Coax Antenna Switch

- Control unit works on 110/220 VAC, 50/60 Hz, and supplies necessary DC to motor.
- Excellent for single coax feed to multiband quads or arrays of monobanders. The five positions allow a single coax feed to three beams and two dipoles, or other similar combinations.
- Control cable (not supplied) same as for HAM-M rotator.
- Selects antennas remotely, grounds all unused antennas. GND position grounds all antennas when leaving station. "Rain-Hat" construction shields motor and switches.
- Motor: 24 VAC, 2 amp. Lubrication good to -40°F.
- Switch RF Capability: Maximum legal limit.
- \$120 suggested Amateur Net

See your Dealer. For details write:



**R. L. DRAKE COMPANY**

540 Richard St., Miamisburg, Ohio 45342  
Phone: (513) 866-2421 • Telex: 288-017



# 2 METER FM

# AND HF TOO ...

# HEADQUARTERS

## ERICKSON NEW STORE

### GRAND OPENING SPECIAL!



## MOTOROLA METRUM II

# \$249<sup>50</sup>

 (half suggested list!)

Cash and carry price



### FEATURES:

- 25 Watts out
- Hot, selective receiver
- 12 channels
- Single crystal R/T
- PL provision built in

### SPECIFICATIONS:

Transmitter Power: 1W/25W  
 Receiver Sensitivity: .2uV  
 Power Requirement: .3 A receive,  
 7.5 A transmit (25W)

Size: 2<sup>3</sup>/<sub>4</sub>x11x9<sup>1</sup>/<sub>4</sub> inches

Optional PL, AC power supply  
and multiple repeater offset kits available

Mail orders shipped UPS same day on receipt of cashier's check or money order. Mail orders add \$10 for handling and shipping.

Ask for our very competitive prices on:

- ASP
- Atlas
- CDE Rotors
- Collins
- Cushcraft
- Data Signal
- Dentron
- Drake
- Hy-Gain
- Icom
- Kenwood
- Larsen
- Mosley
- Newtronics
- Regency
- Standard
- Swan
- TPL
- Ten-Tec
- Yaesu

HOURS: 9:30 - 9 Mon. & Thurs.; 9:30 - 5:30 Tues., Wed. & Fri.; 9 - 3 Sat.

Open more than 50 hours a week to serve you better

## ERICKSON COMMUNICATIONS, INC.

5935 North Milwaukee Ave., Chicago, IL 60646

(312) 631-5181

**We Service What We Sell**

# THE INDESTRUCTIBLE PAIR PROTECT YOUR EQUIPMENT

Full over voltage and over current protection!!!

Now our best selling high current amateur power supplies are even better.

The PS-25C and PS-15C are well filtered and regulated power supplies.

Top quality components insure optimum reliability.

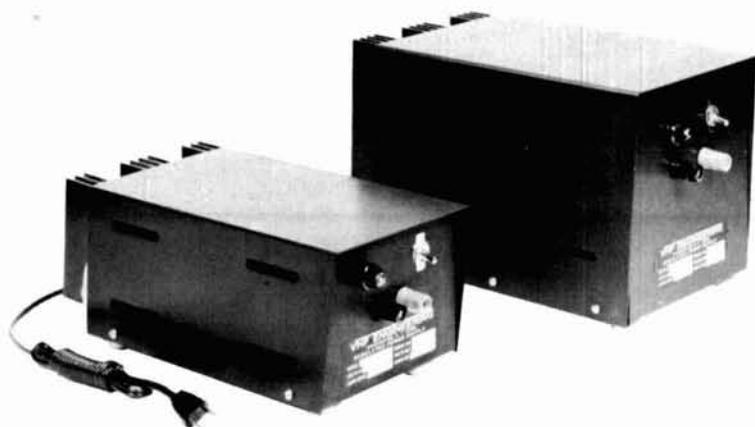

PS-15C  
SPECIFICATIONS

Voltage Output:  
adjustable between 12-14V  
Load Regulation:  
2% from no load to 10 amps  
Current Output:  
15 amps intermittent (50% duty cycle)  
10 amps continuous  
Ripple:  
50 mV at 10 amps  
Weight:  
11-1/2 pounds  
Size:  
11-1/4" x 5-1/2" x 4-3/4"

Kit ..... \$79.95  
Wired and tested ..... 94.95

Look at these features:

- Over-voltage protection crowbar.
- Electrostatic shield for added transient surge protection.
- A foldback output limiter operates for loads outside of the operating range.
- Isolation from ground. The circuit is isolated from the case and ground.
- 115/220 volt input – 50/60 cycle.
- Units are factory wired for 110 volt AC, 50/60 cycle power. A simple jumper will reconfigure the input for 220 volt AC, 50/60 cycles.
- Temperature range – operating: 0° to +55° C.
- Black anodized aluminum finish.

PS-25C  
SPECIFICATIONS

Voltage Output:  
adjustable between 10-15V  
Load Regulation:  
2% from no load to 20 amps  
Current Output:  
25 amps intermittent (50% duty cycle)  
20 amps continuous  
Ripple:  
50 mV at 20 amps  
Weight:  
20-1/2 pounds  
Size:  
12-1/4" x 6-3/4" x 7-1/2"

Kit ..... \$129.95  
Wired and tested ..... 149.95

## ORDER FORM

Item	Part No.	Description	Price	Extension

Name \_\_\_\_\_ Total \_\_\_\_\_  
Address \_\_\_\_\_ Shipping \_\_\_\_\_  
City \_\_\_\_\_ NYS Resident \_\_\_\_\_  
State \_\_\_\_\_ Zip \_\_\_\_\_ Total \_\_\_\_\_  
Master Charge or BankAmericard No. \_\_\_\_\_ Enclosed \_\_\_\_\_  
Bank No. \_\_\_\_\_ Expiration Date \_\_\_\_\_

TERMS: C.O.D., cash or check with order. We also accept BankAmericard and Master Charge.  
CLAIMS: Notify VHF and the carrier of damage within seven (7) days of receipt of shipment.  
RETURNS: Obtain authorization from VHF before returning any merchandise.  
PRICES AND SPECIFICATIONS: Subject to change without notice.  
SHIPPING INFORMATION: All shipments are F.O.B. Binghamton, N.Y. 13902. Shipments will be made by the most convenient method. Please include sufficient funds to cover shipping and handling. Allow 3 to 4 weeks for delivery.

**Vhf engineering**

DIVISION OF BROWNIAN ELECTRONICS CORP.

320 WATER ST. • P.O. BOX 1921  
BINGHAMTON, N.Y. 13902 • 607-723-9574

WE HONOR



THE INTERBANK CARD





YAESU FT-101E TRANSCEIVER

# Now, more radio from the radio company.

Are Yaesu's FT-101's the finest all-around transceivers in the world? Yes — and now the best is even better. The new FT-101E includes a potent R. F. speech processor. Plus improved, easy-to-use lever switches. A more refined clarifier control for push-button, independent clarifier operation. There's also a 160 meter crystal included without extra charge.

And all the other features that have made the FT-101 series of transceivers among the world's most popular are still here: 260 watts SSB

PEP. Globe-circling power on CW and AM. 160 to 10 meters range. 0.3uV receiving sensitivity. And one very important feature you never want to forget is the famous Yaesu warranty, strong dealer network and convenient serviceability.

If you're a serious amateur, you're always looking for more radio. And the FT-101E is just that. \$749\* buys you a million bucks worth of enjoyment. See your Yaesu dealer or write for our catalog. Yaesu Musen USA, Inc. 7625 E. Rosecrans, No. 29, Paramount, Calif. 90723.

YAESU  
***The radio.***

\*FT-101EE \$659.  
FT-101EX \$599.

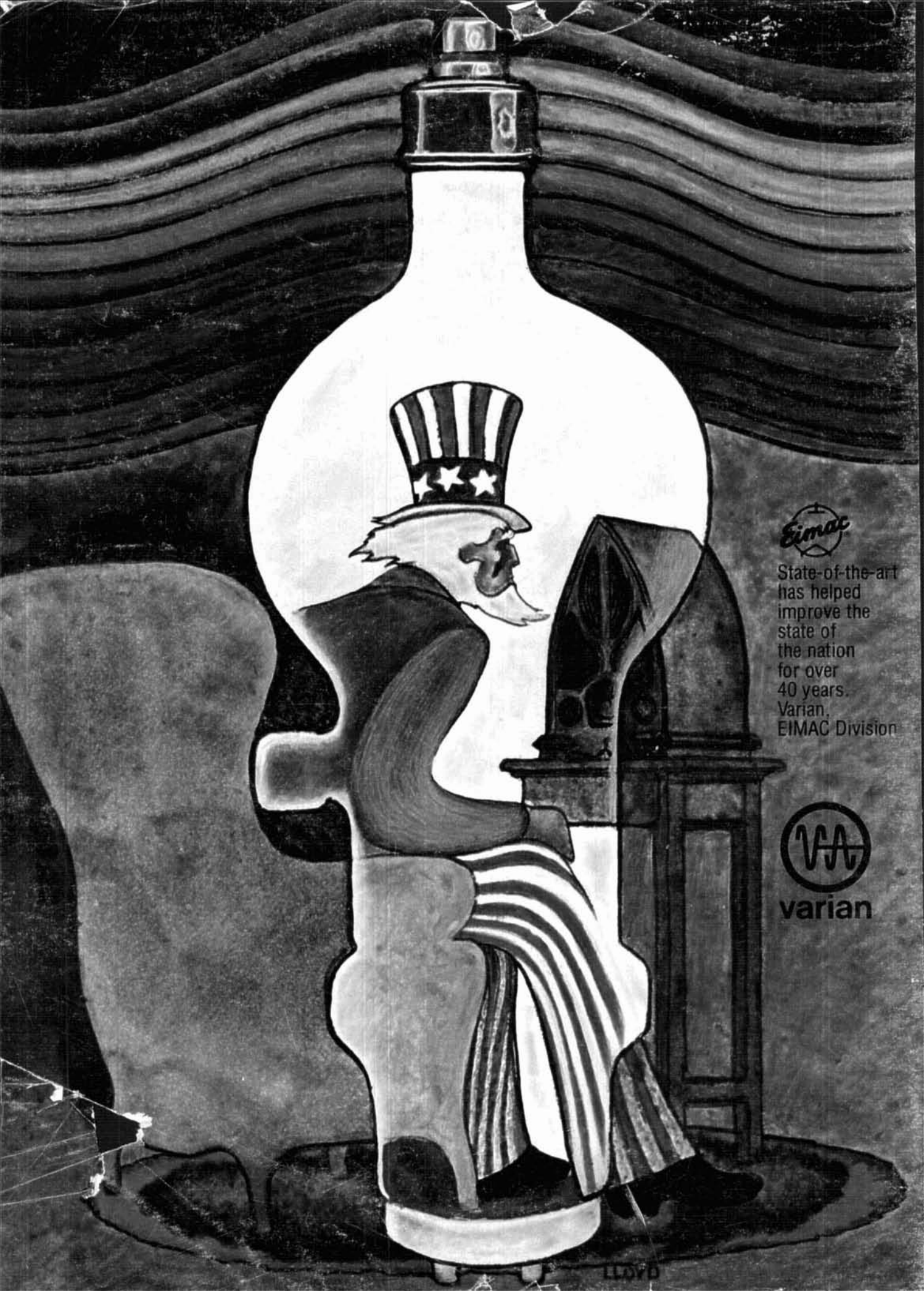

State-of-the-art  
has helped  
improve the  
state of  
the nation  
for over  
40 years.  
Varian,  
EIMAC Division



varian